

MEDICON eG · GERMANY · 47° 57' 31.4" N · 8° 46' 58.6" E



Plastic Surgery

Instrumente für die plastische Chirurgie

Instruments for Plastic Surgery

Instrumentos para la cirugía plástica

Instrumentes pour la chirurgie plastique

Strumenti per la chirurgia plastica

medicon[®]



Not all products illustrated in this documentation are available for sale in all countries. Please contact your local distributor for more information concerning availability and regulatory information (e.g. classification) of the mentioned products.



Instrumente für die Plastische Chirurgie
Instruments for Plastic Surgery
Instrumentos para cirugía plástica
Instruments pour la chirurgie plastique
Strumenti per la chirurgia plastica

Die Entwicklung, Herstellung und der Vertrieb chirurgischer Instrumente und Implantate haben bei uns eine jahrzehntelange Tradition. In unseren 11 Mitgliedsbetrieben werden über 35.000 verschiedene Artikel für die Humanmedizin gefertigt.

Wir haben es uns zur Aufgabe gemacht, Chirurgen und OP-Personal der Plastischen Chirurgie mit innovativen Instrumenten zu versorgen, welche die Fortschritte der operativen Behandlung unterstützen.

Mit Verantwortung und Engagement bündeln wir unsere Aktivitäten in drei Kernkompetenzen.

Our company has decades of experience in developing, manufacturing and selling surgical instruments and implants. Our 11 member companies produce over 35,000 different items for human medicine.

We have made it our goal to supply surgeons and surgical personnel in plastic surgery with innovative instruments, which support the progress in surgical treatment.

With responsibility and commitment, we focus our activities on three core competencies.



El desarrollo, la fabricación y la distribución de implantes e instrumentos quirúrgicos representa para nosotros décadas de tradición. En los talleres de nuestros 11 socios se fabrican más de 35.000 artículos diferentes para la medicina humana.

Nos hemos propuesto la tarea de abastecer a cirujanos y a personal de quirófano de la cirugía plástica con innovadores instrumentos que respaldan el progreso del tratamiento quirúrgico.

Con responsabilidad y compromiso, centramos nuestra actividad en tres competencias básicas.

Le développement, la fabrication et la vente d'instruments chirurgicaux et d'implants sont pour nous une tradition longue de plusieurs décennies.

Nos 11 entreprises membres produisent plus de 35.000 articles différents dans le secteur de la médecine.

Nous nous sommes fixés pour objectif de fournir aux chirurgiens et au personnel opératoire actifs dans le secteur de la chirurgie plastique des instruments novateurs suivant les progrès du traitement opératoire.

Avec conscience et engagement, nous regroupons nos activités dans trois compétences majeures.

Lo sviluppo, la produzione e la distribuzione di strumenti chirurgici e impianti hanno da noi una tradizione pluridecennale.

Nelle nostre 11 aziende associate, vengono fabbricati oltre 35.000 diversi articoli per la medicina umana.

Il compito che ci siamo proposti è quello di fornire ai chirurghi e al personale di sala operatoria di chirurgia plastica strumenti innovativi che supportano i progressi del trattamento chirurgico.

Con responsabilità e impegno riuniamo le nostre attività in tre competenze di base.



CMF

Das Kompetenzfeld **CMF** kombiniert unsere modular aufgebauten Systeme für die Distraction und Osteosynthese in der kranio-maxillo-fazialen Chirurgie mit anwendungs-optimierten Lösungen und intuitiver Bedienbarkeit zu einem zukunfts-orientierten Konzept.

The competence field **CMF** combines our modular systems for distraction and osteosynthesis in cranio-maxillofacial surgery with application-optimised solutions and intuitive operation to produce a forward-looking concept.

SURGICAL

Das Kompetenzfeld **SURGICAL** vernetzt unsere mehr als siebzigjährige Erfahrung als Medizintechnik-Unternehmen mit weit über 35.000 Produkten, die nahezu alle Indikationen der einzelnen chirurgischen Fachbereiche abdecken.

The competence field **SURGICAL** links our more than seventy years of experience as a medical technology company with over 35,000 products covering nearly all indications of the individual surgical specialty fields.

NEURO+SPINE

Das Kompetenzfeld **NEURO+SPINE** konzentriert sich auf unser Produkt-Portfolio von qualitativ hochwertigen Instrumenten und innovativen Implantaten für die Neurochirurgie mit dem Fokus der produktbezogenen Spezialisierung als Grundlage einer transparenten Vertriebsstrategie.

The competence field **NEURO+SPINE** focuses on our product portfolio of high-quality instruments and innovative implants for neurosurgery with the main emphasis on product-related specialisation as a basis for a transparent sales strategy.

El área de especialización **CMF** combina nuestro sistema modular para la distensión y osteosíntesis en la cirugía cráneo-maxilofacial con soluciones orientadas a la aplicación y un manejo intuitivo para desarrollar un concepto enfocado hacia el futuro.

Le domaine de compétence **CMF** associe nos systèmes modulaires utilisés pour la distraction et ostéosynthèse en chirurgie crânio-maxillo-faciale à des solutions d'application optimisées et à une manipulation intuitive. Le résultat: Un concept d'avenir.

L'area di competenza **CMF** associa i nostri sistemi componibili per la distrazione e la osteosíntesi nella chirurgia cranio-maxillo-facciale a soluzioni ottimizzate nell'applicazione e manipolazione intuitiva, per un concetto orientato al futuro.

El área de especialización **SURGICAL** fusiona nuestros más de 70 años de experiencia como empresa de tecnología médica con más de 35.000 productos que cubren casi todas las indicaciones de cada una de las disciplinas quirúrgicas.

Le domaine de compétence **SURGICAL** allie notre expérience de plus de dix-sept ans dans le secteur des techniques médicales à plus de 35.000 produits, couvrant la quasi-totalité des indications de la chirurgie actuelle.

L'area di competenza **SURGICAL** collega la nostra ultrasettantennale esperienza aziendale nel campo della tecnica medica con oltre 35.000 prodotti che soddisfano quasi tutte le indicazioni delle singole aree di specializzazione chirurgiche.

El área de especialización **NEURO+SPINE** se centra en nuestra cartera de productos de instrumentos de alta calidad e implantes innovadores para la neurocirugía considerando la especialización relacionada con los productos como base de una estrategia de ventas transparente.

Le domaine de compétence **NEURO+SPINE** se concentre sur notre gamme d'instruments de grande qualité et d'implants novateurs pour la neurochirurgie, avec une spécialisation sur les produits comme base d'une stratégie de vente transparente.

L'area di competenza **NEURO+SPINE** si concentra sul nostro portfolio di strumenti di alta qualità e impianti innovativi per la neurochirurgia, e si propone come focus la specializzazione del prodotto come base di una trasparente strategia di distribuzione.

Der Ihnen vorliegende Katalog "Plastic Surgery" bleibt unser Eigentum, auch wenn eine Leih- oder Schutzgebühr bezahlt wurde. Er darf nur zum Einkauf und Vertrieb der darin beschriebenen MEDICON-Produkte durch den dazu autorisierten Fachhandel und für die Bedarfsbeschaffung durch den jeweiligen Anwender verwendet werden. Seine Verwendung gegen unsere Interessen berechtigt uns zur sofortigen Rückforderung und möglichen weitergehenden Maßnahmen. Ohne unsere ausdrückliche, schriftliche Genehmigung darf dieser Katalog weder im Gesamten noch auszugsweise nachgedruckt oder kopiert werden.

This present "Plastic Surgery" catalogue remains exclusively our property even if a lending fee or charge has been paid for it. It shall only be used by specialized dealers to buy and sell MEDICON products or by individual users to meet their own requirements. In case of misuse we are entitled to recall the catalogue immediately and to take further steps if necessary. It is not allowed to reprint or copy this catalogue in whole or in parts without our written permission.

El presente catálogo "Plastic Surgery" sigue siendo nuestra propiedad aunque se ha pagado ciertos derechos de préstamo. Debe servir a los revendedores autorizados del ramo exclusivamente para la compra y la distribución de los productos MEDICON que describe, y a los especialistas y usuarios particulares para escoger los instrumentos necesarios para su abastecimiento. Su empleo abusivo en perjuicio de nuestros intereses, nos da derecho a exigir su devolución inmediata y a tomar todas las medidas ulteriores que juzguemos necesarias. Sin nuestro permiso expreso por escrito es prohibido reproducir o copiar este catálogo, tanto en su totalidad como en extractos.

Le présent catalogue "Plastic Surgery" demeure notre propriété, même après acquittement d'une taxe autorisée ou taxe de prêt. Il ne peut être utilisé que pour l'achat ou la vente des produits MEDICON qui y sont décrits, par des spécialistes y étant autorisés et par l'utilisateur pour l'approvisionnement de ses besoins. Son utilisation contre nos intérêts nous autorise à une demande en restitution immédiate et à la prise éventuelle de mesures disciplinaires. Sans autorisation formelle écrite, ce catalogue ne peut être ni réimprimé, ni copié, que ce soit complètement ou partiellement.

Il presente catalogo "Plastic Surgery" rimane di nostra proprietà anche se è stato pagato un diritto di noleggio o di proprietà riservata. Esso può essere adoperato soltanto per l'acquisto e la vendita dei prodotti MEDICON ivi descritti attraverso il commercio specializzato e autorizzato o per l'approvvigionamento tramite chi, di volta in volta, li impiega. L'uso del catalogo contro i nostri interessi ci autorizza al suo immediato ritiro e possibili ulteriori provvedimenti. Senza la nostra esplicita autorizzazione scritta questo catalogo non può essere ristampato o copiato nè integralmente nè parzialmente.

Modelländerungen vorbehalten
Patterns are subject to change without further notice
Salvo modificaciones
Tous droits réservés des changements de modèle
Ci riserviamo la facoltà di cambiamenti nei modelli

Für Druckfehler übernehmen wir keinerlei Haftung
We are not liable for misprints
Declinamos toda responsabilidad por los errores de impresión que pueda contener este documento
Nous déclinons toute responsabilité en cas d'erreurs d'impression
Non ci assumiamo nessuna responsabilità per eventuali errori di stampa

Gedruckt in Deutschland
Printed in Germany
Impreso en Alemania
Imprimé en Allemagne
Stampato in Germania
Trykkes i Tyskland

© Copyright 06/2024, MEDICON eG, Tuttlingen, Germany



Gerne haben wir die freundliche Unterstützung und Mitarbeit des Künstlers Peter Schmid angenommen. Für die Bereitstellung seiner Arbeiten zur Mitgestaltung unseres Kataloges bedanken wir uns herzlich. Farbabweichungen von Abbildung und Original sind aufgrund technischer Umstände möglich.

We appreciate the friendly support and collaboration of the artist Peter Schmid who provided us with his works for the design of our catalogue. Colour variations are possible due to technical specifications.

Agradecemos el gentil soporte y la colaboración del artista Peter Schmid y, les queremos dar las gracias por habernos puesto a disposición sus obras para la creación de nuestro catálogo. Son posibles pequeñas variaciones de color con respecto al producto.

Nous sommes très reconnaissants pour le support et la collaboration amicale de l'artiste Peter Schmid et nous remercions vivement d'avoir mis à notre disposition ses œuvres pour le design de notre catalogue.

Pour des raisons techniques des différences minimales de couleur sont possibles.

Con molto piacere abbiamo accettato il gentile sostegno e la collaborazione dell'artista Peter Schmid. Desideriamo ringraziarla di cuore per la sua disponibilità e per il suo rapporto nella redazione del nostro catalogo.

Differenze fra illustrazione e originale sono possibili per motivi tecnici.



**Künstlerportrait
Portrait of the Artists
Retrato de los artistas
Portrait des artistes
Ritratto degli artisti**



Owner Peter Schmid



*I*ch sehe mich selbst als Künstler und als Handwerker. Ein Künstler bringt die verborgene Schönheit in Menschen, Orten und Materialien zum Vorschein; ein Handwerker weiß, wie man Ideen in fertige Objekte umsetzt.

Unsere Arbeit gründet sich auf Materialien, die aus der Natur stammen, meine Inspiration aber sind die Städte. Das Leben in der Stadt, veranschaulicht durch Kunst, Musik, Architektur, die Kreuzungspunkte zwischen Mensch, Kreativität und Natur bilden das Fundament für meine Designideen.

In unserem Atelier am wunderschönen Bodensee stellen mein Team und ich einmalige, tragbare Kunststücke her. Es ist mein Ziel, die stark im Handwerk verwurzelte Tradition der Schmuckherstellung fortzuführen und dabei mutig nach neuen Ausdrucksformen zu suchen, ohne mich von Traditionen einschränken zu lassen.

Seit über 40 Jahren steht das Atelier Zobel für höchst individuellen, ausdrucksstarken und gefühlsbetonten Schmuck von zeitloser Schönheit.

I think of myself as an artist and as a craftsman. The artist unlocks the hidden beauty in people, places and materials; the craftsman knows how to transform ideas into a finished object.

Materials that emerge from nature are the base of our work, however cities are my inspiration.

The urban life exemplified in art, music, architecture, the intersections between man, creativity and nature provide the foundation for my design ideas.

Working by the beautiful Lake Constance, my team and I, craft unique works of wearable art. My aim is to continue a tradition of jewelry-making that is rich in craftsmanship, not confined by tradition, but rather, courageously seeking new expressions. For more than 40 years, Atelier Zobel has stood as byword for highly individual, bold and emotive jewelry of timeless beauty.

*M*e considero un artista y un artesano. El artista revela la belleza oculta de las personas, lugares y materiales y el artesano sabe cómo transformar las ideas en un objeto final.

Los materiales de la naturaleza son la base de nuestro trabajo, aunque las ciudades son mi fuente de inspiración. La vida urbana ejemplificada en el arte, la música, la arquitectura, las intersecciones entre el hombre, la creatividad y la naturaleza son la piedra angular de mis ideas de diseño.

A orillas del precioso lago Constanza, mi equipo y yo creamos excepcionales obras de arte. Mi objetivo es continuar con una tradición de joyería con un gran carácter artesanal, que, al contrario de verse limitada por la tradición, esté siempre a la búsqueda de nuevas expresiones.

Durante más de 40 años, Atelier Zobel ha sido sinónimo de joyería extremadamente individual, audaz y emotiva de una belleza atemporal.



*J*e me considère comme un artiste et un artisan. L'artiste libère la beauté cachée des gens, des endroits et des matières ; l'artisan sait comment transformer les idées en un objet fini. Les matières qui proviennent de la nature sont la base de notre travail, cependant mon inspiration vient des villes. La vie urbaine illustrée par l'art, la musique, l'architecture, les croisements entre l'homme, la créativité et la nature fournissent la base de mes idées de conception. Mon équipe et moi travaillons sur les bords du lac de Constance et nous réalisons des objets d'art à porter unique. Mon but est de perpétuer une tradition de joaillerie d'une haute qualité de travail, non pas engoncée dans la tradition mais cherchant courageusement de nouvelles expressions. Pendant plus de 40 ans, l'atelier Zobel a été synonyme de bijoux très individuels, voyants et émotionnels d'une beauté atemporelle.

*P*ensando a me stesso mi vedo come un artista e come un artigiano. L'artista porta alla luce la bellezza nascosta nelle persone, nei luoghi e nella materia; l'artigiano sa come trasformare le idee in un prodotto finito. Le materie che nascono dalla natura sono la base del nostro lavoro, tuttavia le città rappresentano le mie muse ispiratrici. La vita cittadina incarnata nell'arte, nella musica, nell'architettura, gli incroci tra l'uomo, la creatività e la natura forniscono le fondamenta per la progettazione delle mie idee. Nella splendida cornice del lago di Costanza io e il mio team realizziamo opere d'arte uniche da indossare. Il mio intento è di portare avanti la tradizione della gioielleria artigianale non limitata dalla consuetudine ma piuttosto alla ricerca in modo coraggioso di nuove espressioni. Da più di 40 anni l'Atelier Zobel è sinonimo di gioielleria dalla bellezza senza tempo estremamente individuale, audace e che suscita emozioni.



Peter Schmid · Atelier Zobel · 78462 Konstanz
www.atelierzobel.com



A Grundinstrumente Basic Instruments Instrumentos básicos Instrumenti di base		
A01	Skalpelle Scalpels Bisturies Bistouris Bisturi	2
A02	Scheren Scissors Tijeras Ciseaux Forbici	5
A03	Pinzetten Forceps Pinzas Pinces Pinze	45
A04	Nadelhalter Needle holders Porta-agujas Porte-aiguilles Portaghi	58
A05	Arterienklemmen Hemostatic forceps Pinzas hemostáticas Pinces hémostatiques Pinze emostatiche	73
A06	Mikro-Gefäßclips und Anlegepinzetten Micro vessel clips and applying forceps Micro clips vasculares y pinzas para aplicar Micro clips vasculaires et pinces à appliquer Micro clip vascolari e pinze per applicare	77
A07	Wundhaken Retractors Separadores Ecarteurs Divaricatori	81
A08	Wundspreizer Self-retaining retractors Separadores autoestáticos Ecarteurs autostatiques Divaricatori autostatici	99
B Spezialinstrumente Special Instruments Instrumentos especiales Instrumenti speciali		
B01	Raspatorien Raspatories Legras Rugines Periostotomi	104
B02	Osteotome und Maxilla-Mobilisator Osteotomes and maxilla mobilizer Osteotomos y movilizador para maxilar Osteotomes et mobilisateur pour maxillaire Osteotomi e mobilizzatore per mascella	111
B03	Knorpel- und Knocheninstrumente Cartilage and bone instruments Instrumentos para cartilago y huesos Instruments à cartilage et os Strumenti per cartilagine e ossa	116
B04	Lippen- und Gaumenspalteninstrumente Lip and cleft palate instruments Instrumentos para labios y fisuras paladares Instruments pour lèvres et fissures palatines Strumenti per labbra e fessure del palato	118
B05	Lippen- und Wangenhalter Lip and cheek retractors Separadores de labios y mejillas Ecarteurs de lèvres et de joues Divaricatori per labbra e guance	121

B06	Mundsperrer Mouth gags Abrebocas Ouvre-bouches Apribocca	122
B07	Markierungs- und Messinstrumente Marking and measuring instruments Instrumentos para marcar y medir Instruments à mesurer et marquer Strumenti per marcare e misurare	125
B08	Mikro-Sägen mit Silikongriff Micro saws with silicone handle Micro sierras con mango de silicona Micro scies avec poignée en silicone Micro seghe con impugnatura in silicone	130
B09	Drähte und Drahtinstrumente Wires and wire instruments Alambre e instrumentos para alambres Fils et instruments pour fils métalliques Fili e strumenti per fili d'acciaio	136
B10	Koriotom und Dermatome Coriotome and dermatomes Coriotomo y dermatomos Coriotome et dermatomes Coriotomo e dermatomi	138
C	Rhinoplastik Rhinoplasty Rinoplastica Rhinoplastie Rinoplastica	
C01	Rhinoplastikscheren Rhinoplasty scissors Tijeras para rinoplastia Ciseaux pour rhinoplastie Forbici per rinoplastica	142
C02	Pinzetten, Nadelhalter Forceps, Needle holders Pinzas, Porta-agujas Pincés, Porte-aiguilles Pinze, Portaghi	149
C03	Wundhaken Retractors Separadores Ecarteurs Divaricatori	151
C04	Nasenspekula Nasal specula Espéculos nasales Spéculums nasaux Specoli nasali	153
C05	Nasenraspeln Nasal rasps Raspadores nasales Râpes nasales Raspe nasali	156
C06	Nasenflügelhaken, Nasenhaken Alar retractors, Nasal retractors Separadores para las alas nasales, Separadores nasales Ecarteurs pour les ailes du nez, Ecarteurs nasaux Divaricatori alette nasali, Divaricatori nasali	162
C07	Nasenzangen und Nasensägen Nasal forceps and nasal saws Pinzas nasales y sierras nasales Pincés nasales et scies nasales Pinze nasali e seghe nasali	167
C08	Nasenseptumzangen und Rhinoplastikmesser Nasal septum forceps and rhinoplasty knives Pinzas para tabique nasal y chuchillos para rinoplastia Pincés pour la cloison nasale et couteaux pour rhinoplastie Pinze per il setto nasale e bisturi per rinoplastica	172
C09	Elevatoren und Mukosamesser Elevators and mucosa knife Elevadores y cuchillo para mucosa Élévateurs et septotome Elevatori e coltello per mucosa	175

C10	Raspatorien Raspatories Legras Rugines Periostotomi	179
C11	Hämmer, Meißel Mallets, Chisels Martillos, Cinceles Maillets, Gouges Martelli, Sgorbie	183
C12	Osteotome Osteotomes Osteotomos Ostéotomes Osteotomi	186
C13	Knorpel- und Knocheninstrumente Cartilage and bone instruments Instrumentos para cartilago y huesos Instruments à cartilage et os Strumenti per cartilagine e ossa	194
C14	Markierungs- und Messinstrumente Marking and measuring instruments Instrumentos para marcar y medir Instruments à mesurer et marquer Strumenti per marcare e misurare	199
D	Mammoplastik Mammoplasty Mamoplastia Plastie mammaire Plastica mammaria	
D01	Brustdissektoren, Mamillenringe und Brustheber Breast dissectors, Areola markers and breast elevator Disectores mamarios, Marcadores para areola y elevador mamario Dissecteurs mammaires, Marqueurs pour l'aréole et élévateur mammaire Dissettori mammari, Marcatori per areola e elevatore mammario	202
D02	Brustretractoren Breast retractors Separadores mamarios Ecarteurs mammaires Divaricatori mammari	205
E	Infiltration und Fettabsaugung Infiltration and Liposuction Infiltración y liposucción Infiltration et liposuction Infiltrazione e liposuzione	
E01	Kanülen-Ansätze Cannula connectors Conexiones de cánulas Embouts des canules Attacchi cannule	208
E02	Kanülen und Spritzen zur Infiltration Cannulas and syringes for infiltration Cánulas y jeringas de infiltración Canules et seringues pour l'infiltration Cannule e siringhe per infiltrazione	210
E03	Liposuction-Kanülen, Handgriffe für Kanülen Liposuction cannulas, Handles for cannulas Cánulas de liposucción, Mangos para cánulas Canules pour liposuction, Manches pour canules Cannule per liposuzione, Manici per cannule	212
E04	Kanülen zur Eigenfettentnahme Cannulas for autologous fat transfer Cánulas para extracción de grasa autóloga Canules pour le prélèvement de graisse autologue Cannule per l'asportazione del grasso	223
E05	Spritzen und Zubehör Syringes and accessories Jeringas y accesorios Seringues et accessoires Siringhe e accessori	226
E06	Instrumente zur Eigenfettunterspritzung Instruments for lipoinjection Instrumentos para lipoinyección Instruments pour le lipofilling Strumenti per lipofilling	228

E07	Instrumente zur subdermalen Saug-Kürettage bei axillärer Hyperhidrosis Instruments for subdermal suction curettage in case of axillary hyperhidrosis Instrumentos para curetaje y succión subdermal en caso de hiperhidrosis axilar Instruments pour le curettage et la succión subdermal en cas de hyperhydrose axillaire Strumenti per curettagge e l'aspirazione sottodermica in caso di iperidrosi ascellare	232
E08	Infiltrationspumpe für die Liposuction Infiltration pump for liposuction Bomba d'infiltración para la liposucción Pompe d'infiltration pour la liposuccion Pompa d'infiltrazione per la liposuzione	234
F	Abdominoplastik Abdominoplasty Abdominoplastia Abdominoplastie Addominoplastica	
F01	Bauchretractor und Bauchnabelpositionierer Abdominal retractor and navel marker Separador abdominal y posicionador de ombligo Ecarteur abdominal et positionneur du nombril Divaricatore addominale e posizionario dell'ombelico	236
G	Blepharoplastik Blepharoplasty Blefaroplastia Bléfaroplastie Blefaroplastica	
G01	Blepharoplastik Blepharoplasty Blefaroplastia Bléfaroplastie Blefaroplastica	240
H	Endoskopisches Facelifting Endoscopic Facelift Lifting facial endoscópico Lifting facial endoscopique Lifting facciale endoscopico	
H01	Raspatorien, Dissektoren, Elevatorien, Nervhäkchen und Fadenführungsadeln Raspatories, Dissectors, Elevators, Nerve hooks and ligature needles Legras, Disectores, Elevadores, Ganchitos para nervios y agujas para ligaduras Rugines, Dissecteurs, Elévateurs, Crochets à nerfs et aiguilles à ligature Periostotomi, Dissettori, Elevatori, Uncini per nervi e aghi per legatur	244
H02	Fasszangen, Hakenschere und Endoskope Grasping forceps, Hook scissors and endoscopes Pinzas para agarrar, Tijeras de gancho y endoscopios Pinces à saisir, Ciseaux à crochet et endoscopes Pinze per afferrare, Forbici ad uncino y endoscopi	248
J	Ohrmuschelplastik Auricular Plastic Otoplastia Otoplastie Otoplastica	
J01	Instrumente für die Ohrmuschelplastik Instruments for auricular plastic Instrumentos para la otoplastia Instruments pour l'otoplastie Strumenti per l'otoplastica	250
J02	Anthelix-Knorpelfeile für die Ohrmuschelplastik Anthelix cartilage files for auricular plastic Limas para el cartilago del anthelix para la otoplastia Limes pour le cartilage de l'anthélix pour l'otoplastie Lime per cartilagine del anthelix per l'otoplastica	253
K	Instrumente für die Handchirurgie Instruments for Hand Surgery Instrumentos para la cirugía de mano Instruments pour la chirurgie de la main Strumenti per la chirurgia della mano	
K01	Sonde, Fingerspreizer, Knochenhalte-zangen, Knochenpfiem, Sehneninstrumente Probe, Finger spreader, Bone holding forceps, Bone piercer, Tendon instruments Estilete, Separador para dedos, Pinzas para huesos, Punzone, Instrumentos para tendones Stylet, Ecarteur à doigts, Daviers à os, Alène à os, Instruments pour tendons Sonda, Divaricatore per le dita, Pinze affera ossa, Puntaruolo, Strumenti per tendini	256
K02	Endoskopische Spaltung des Karpalbandes Endoscopic incision of the carpal ligament Escisión endoscópica del ligamento carpiano Dédoublément endoscopique du ligament du carpe Sezione endoscopica del legamento carpale	262

L Lagerung und Sterilisation Storage and Sterilization Almacenamiento y esterilización Rangement et stérilisation Magazzinaggio e sterilizzazione			
L01	Sterilgut-Container aus Aluminium Aluminium containers for sterilization Contenedores de aluminio para la esterilización Containers en aluminium pour la stérilisation Contenitori in alluminio per sterilizzazione		268
L02	Trays für feine Instrumente und Endoskope Trays for delicate instruments and endoscopes Bandejas para instrumentos delicados y endoscopios Cassettes pour instruments délicats et endoscopes Cassette per strumenti delicati ed endoscopi		270
L03	Instrumentenablage (magnetisch) und Instrumentenpflegeöle Instrument mat (magnetic) and instrument maintenance oils Estera para instrumentos (magnético) y aceites para el mantenimiento de instrumentos Tapis pour instruments (magnétique) et huiles d'entretien des instruments Tappetino per strumenti (magnetico) ed oli di manutenzione per strumenti		273
M Siebvorschläge Set Suggestions Proposiciones de juegos Propositions pour boîtes Proposte di set			
M01	Rhinoplastik Rhinoplasty Rinoplastia Rhinoplastie Rinoplastica	GUBISCH	277
M01	Rhinoplastik Rhinoplasty Rinoplastia Rhinoplastie Rinoplastica	DANIEL	282
M02	Ultrafeines mikrochirurgisches Instrumenten-Set Ultra fine micro surgical instrument set Set ultra fino para microcirugía Jeu de microchirurgie ultra-fin Set ultra fino per la microchirurgia	KOSHIMA	285
M03	Gesichts- und Stirnlifting Face and forehead lift Lifting facial y de la frente Lifting facial et frontal Lifting facciale e frontale	SOLZ	286
M04	Blepharoplastik Blepharoplasty Blefaroplastia Blépharoplastie Blefaroplastica	SOLZ GUBISCH	288 289
M05	Mammoplastik Mammoplasty Mamoplastia Plastie mammaire Plastica mammaria	SOLZ	290
M06	Entnahme von Rippenknorpel Harvesting of costal cartilages Toma de cartílago de costilla Prélèvement de cartilages des côtes Prelievo di cartilagine costale	NAGATA	291
M07	Rippenspanentnahme Rib harvest Extracción de viruta ósea de las costillas Prélèvement de cartilage des côtes Prelievo di truciolo costale	DANIEL-GUBISCH	292
M07	Rippenspanentnahme Rib harvest Extracción de viruta ósea de las costillas Prélèvement de cartilage des côtes Prelievo di truciolo costale	DANIEL-GUBISCH Rib Harvest Set	294
M08	Aurikular-Rekonstruktion mit Rippenknorpel Auricular reconstruction with costal cartilages Reconstrucción auricular con cartílago de costilla Reconstruction auriculaire avec cartilages des côtes Ricostruzione auricolare con cartilagine costale	NAGATA	295

M09	Abdominoplastik Abdominoplasty Abdominoplastia Abdominoplastie Addominoplastica	SOLZ	297
M10	Präparation von Vollhauttransplantaten Preparation of skin graft Preparación de injertos de piel entera Préparation des greffes de peau entière Preparazione di innesti della cute intera	KASTEN	298
M11	Mikrochirurgie Micro Surgery Microcirugía Microchirurgie Microchirurgia		299
N	Alphabetischer und numerischer Index Alphabetical and Numerical Index Índice numérico y alfabético Index numérique et alphabétique Indice numerico e alfabetico		
N01	Alphabetischer Index	DEUTSCH	302
N02	Alphabetical index	ENGLISH	312
N03	Índice alfabético	ESPAÑOL	322
N04	Index alphabétique	FRANÇAIS	331
N05	Indice alfabetico	ITALIANO	340
N06	Numerischer Index Numerical Index Índice numérico Index numérique Indice numerico		350



Unsere Instrumenten-Abbildungen haben eine Größe von ca. 50 %. Andere Darstellungsgrößen werden im Maßstab (zum Beispiel 1:1) angegeben. Die dazugehörigen Detailbilder sind in Originalgröße (100 %) abgebildet. Die angegebenen Bemaßungen unterliegen herstellungsbedingt einer Fertigungstoleranz.

In general the instrument illustrations are scaled to be approximately 50 % of actual size. If other scales are used they are indicated (for example 1:1). The corresponding detailed tip illustrations are shown in actual size (100 %). The stated measurements may have a slight variation in permissible tolerances due to minor variations in manufacturing conditions.

Las ilustraciones de los instrumentos tienen un tamaño de aprox. 50 %. Otros tamaños de las ilustraciones serán indicados con la indicación de una escala (por ejemplo 1:1). Los imágenes detallados pertinentes son en su tamaño original (100 %). Las dimensiones indicadas son sujeto de tolerancias.

Les illustrations de nos instruments sont à 50 % de la taille réelle. D'autres dimensions de représentation sont données avec indication d'échelle (par exemple 1:1). Les images de détail sont projetées en grandeur réelle (100 %). Toutes les dimensions données ont une tolérance de fabrication.

Le illustrazioni dei nostri strumenti hanno una dimensione del 50 %. Altre dimensioni di raffigurazione sono segnate con una scala (per esempio 1:1). Le relative illustrazioni dettagliate sono illustrate in dimensioni originali (100 %). Le dimensioni indicate sono soggette a una tolleranza di fabbricazione.

Beispiel
Example
Ejemplo
Exemple
Esempio

Vorderansicht (Schere gerade)
Front view (straight scissors)
Vista frontal (tijera recta)
Vue de face (ciseaux droits)
Vista frontale (forbice retta)

Seitenansicht (Schere gebogen)
Lateral view (curved scissors)
Vista lateral (tijera curva)
Vue laterale (ciseaux courbes)
Vista laterale (forbice curva)

1:1

Darstellungsgröße
Image sizes
Tamaño de representación
Dimension de représentation
Dimensione di raffigurazione

Instrumentengröße
Instrument size
Tamaño del instrumento
Taille des instruments
Dimensione degli strumenti

14 cm – 5½"	14 cm – 5½"	
03.50.14	03.51.14	standard
203.50.14	203.51.14	supercut
213.50.14	213.51.14	black line
03.50.64	03.51.64	"HM"
203.50.64	202.51.64	supercut plus
223.50.64	222.51.64	magic cut

Artikelnummer
Item number
Número de artículo
Référence
Codice

**Grundinstrumente
Basic Instruments
Instrumentos básicos
Instruments de base
Strumenti di base**

A

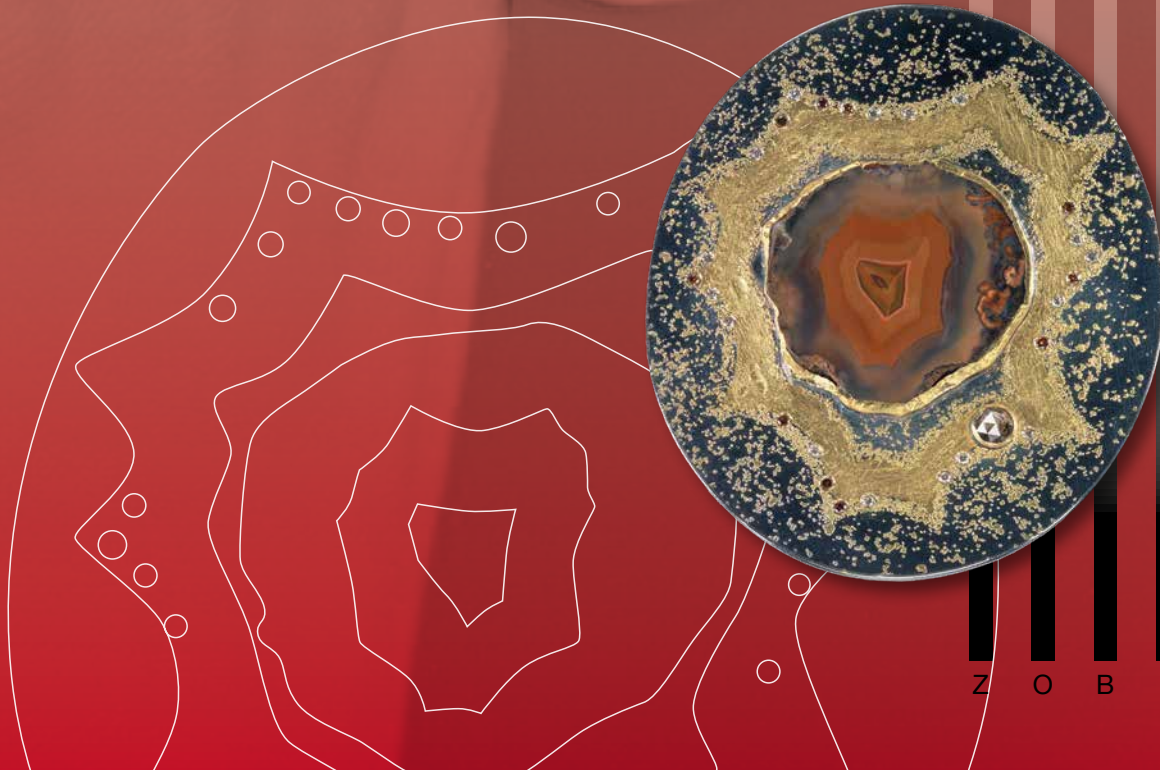

Z O B E L



Skalpellklingen, Skalpellgriffe
Scalpel Blades, Scalpel Handles
Hojas de bisturí, Mangos de bisturí
Lames de bistouris, Manches pour bistouris
Lame per bisturi, Manici per bisturi

A01



1:1

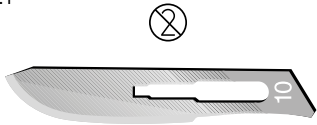

Fig. 10 **01.22.10** P₁₀₀

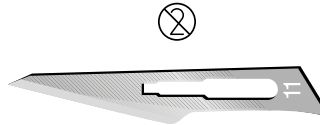

Fig. 11 **01.22.11** P₁₀₀

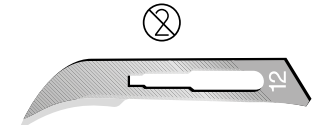

Fig. 12 **01.22.12** P₁₀₀



12,0 cm - 4¾" **01.27.17** no. 7K



12,5 cm - 5" **01.27.03** no. 3



15,5 cm - 6⅛" **01.30.38** **Blake**



15,0 cm - 6" **01.27.40**



16,5 cm - 6½" **01.27.07** no. 7



20,5 cm - 8" **01.27.23** no. 3LA

Verpackung für Skalpellklingen
 Pack of scalpel blades
 Paquete para hojas de bisturí
 Emballage pour lames de bistouris
 Confezione per bisturi



Skalpellklingen, Skalpellgriffe
Scalpel Blades, Scalpel Handles
Hojas de bisturí, Mangos de bisturí
Lames de bistouris, Manches pour bistouris
Lame per bisturi, Manici per bisturi

A01

1:1

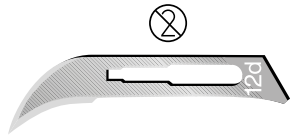

Fig. 12d **01.22.32** P₁₀₀

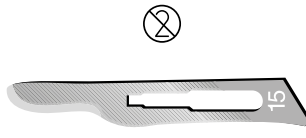

Fig. 15 **01.22.15** P₁₀₀

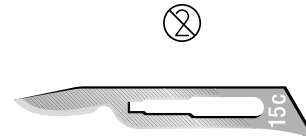

Fig. 15c **01.22.35** P₁₀₀



21 cm - 8¼" **01.27.13** no. 3L



21 cm - 8¼" **01.27.93**



22,5 cm - 9" **01.27.45**



27 cm - 10¾" **01.27.63**

1:1

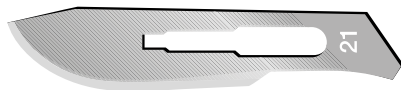

Fig. 21 **01.22.21** P₁₀₀



Fig. 23 **01.22.23** P₁₀₀



21 cm - 8¼" **01.28.14** no. 4L

Verpackung für Skalpellklingen
 Pack of scalpel blades
 Paquete para hojas de bisturí
 Emballage pour lames de bistouris
 Confezione per bisturi



 Einmalprodukt
 Single use product
 Prodotto para un solo uso
 Produit à usage unique
 Prodotto monouso

 Verpackungseinheit "X" Stück (steril)
 Packing unit "X" pieces (sterile)
 Paquete de "X" unidades (estéril)
 Emballage de "X" pièces (stériles)
 Confezione da "X" pezzi (sterile)



Skalpellsklingen, Skalpellsgriffe
Scalpel Blades, Scalpel Handles
Hojas de bisturí, Mangos de bisturí
Lames de bistouris, Manches pour bistouris
Lame per bisturi, Manici per bisturi

A01

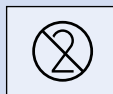
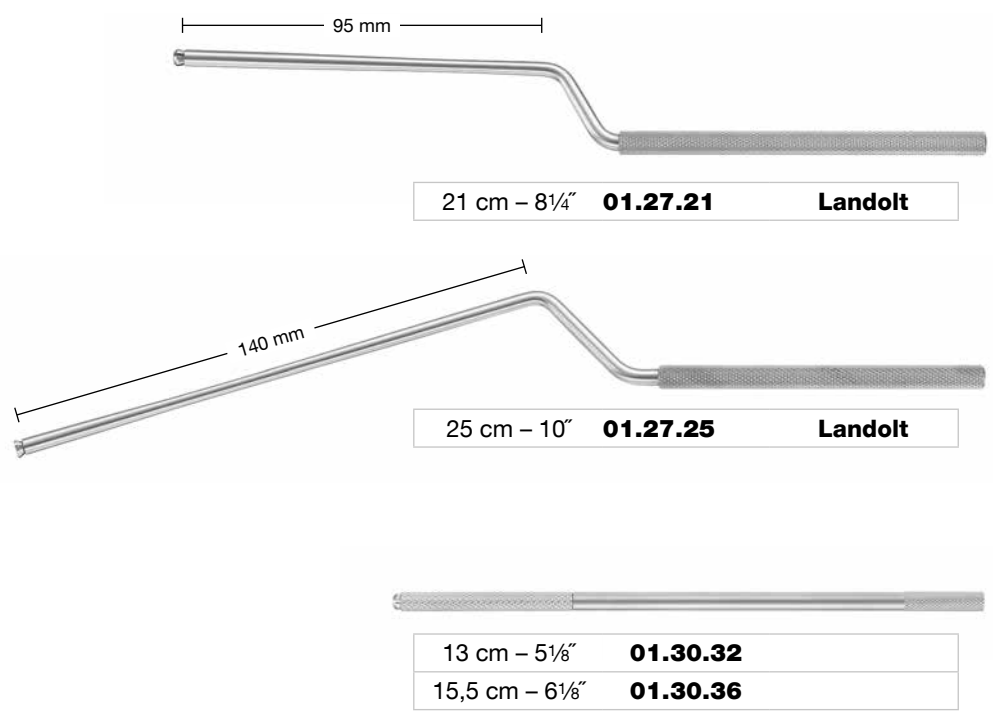
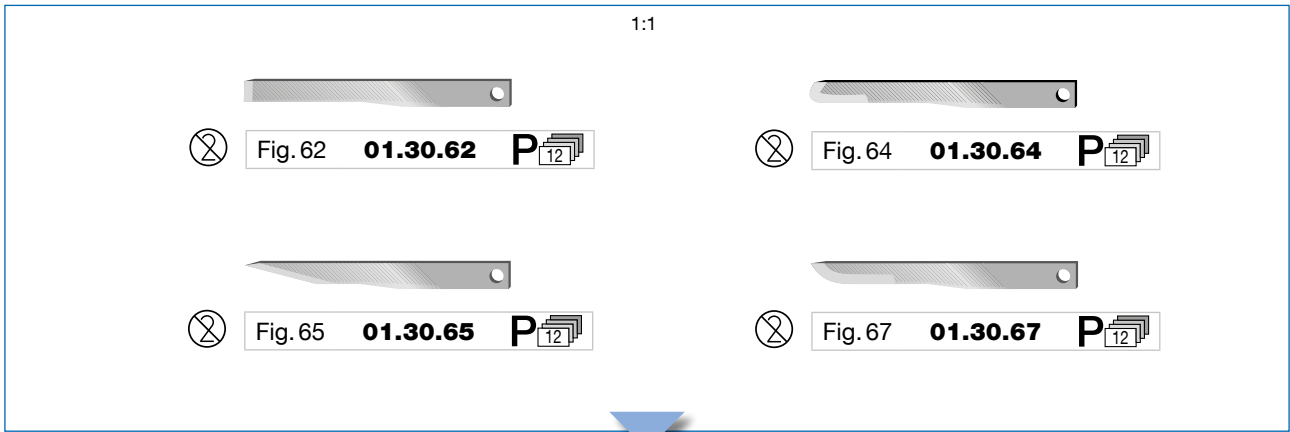

Einmalprodukt
 Single use product
 Producto para un solo uso
 Produit à usage unique
 Prodotto monouso

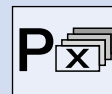

Verpackungseinheit "X" Stück (steril)
 Packing unit "X" pieces (sterile)
 Paquete de "X" unidades (estéril)
 Emballage de "X" pièces (stériles)
 Confezione da "X" pezzi (sterile)

SCISSORS

Von "standard" bis "magic cut" – alle Scheren werden von fachkundigen Chirurgiemechanikern hergestellt, für dauerhafte Leistung sorgfältig gehärtet und qualitätsgerecht geprüft. Die besonderen Eigenschaften unserer Sondermodelle sind auf den Folgeseiten dargestellt.

Starting with "standard" up to "magic cut" – all scissors are manufactured by experienced professionals. They are thoroughly hardened to ensure a long-lasting performance and are quality-checked. The specific characteristics of our special models are explained on the following pages.

Desde tijeras "standard" hasta "magic cut" – todas las tijeras son fabricadas por expertos competentes. Las tijeras son templadas e investigadas respecto a la calidad para un durable rendimiento. Las características de los modelos especiales son mencionadas en las paginas siguientes.

De "standard" à "magic cut" – tous les ciseaux sont fabriqués par des mécaniciens de chirurgie compétents, sont trempés soigneusement afin d'obtenir une performance durable et passent un contrôle de qualité. Les caractéristiques particulières de nos modèles spéciaux sont décrites sur les pages suivantes.

Dalla "standard" alla "magic cut" – tutte le forbici sono prodotte da meccanici chirurgici specializzati. Per una lunga durata sono temprate accuratamente e devono passare il controllo di qualità. Sulle prossime pagine sono illustrate le particolarità dei nostri modelli esclusivi.

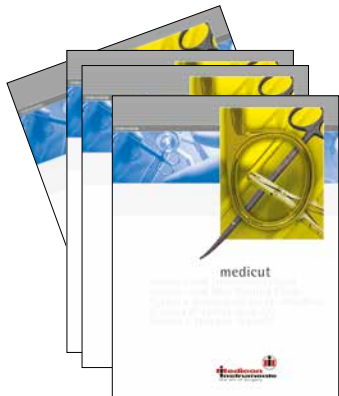

451.03.23

Unser komplettes Scheren-Programm finden Sie in unserem Sonderprospekt.
For our complete scissors line, see our special brochure.
El programa completo de tijeras se encuentra en nuestro folleto especial.
Vous trouverez notre programme complet des ciseaux dans notre prospectus spécial.
Troverete il nostro programma completo di forbici nel nostro depliant speciale.



A02

supercut

Goldene Schraube
Golden screw
Tornillo dorado
Vis dorée
Vite dorata

**black line**

Goldene Schraube und schwarze Ringgriffe
Golden screw and black rings
Tornillo dorado y anillos negros
Vis dorée et anneaux noirs
Vite dorata e anelli neri

**"HM"**

Goldene Ringgriffe
Golden rings
Anillos dorados
Anneaux dorés
Anelli dorati

**supercut plus**

Goldene Schraube und goldene Ringgriffe
Golden screw and golden rings
Tornillo dorado y anillos dorados
Vis dorée et anneaux dorés
Vite dorata e anelli dorati

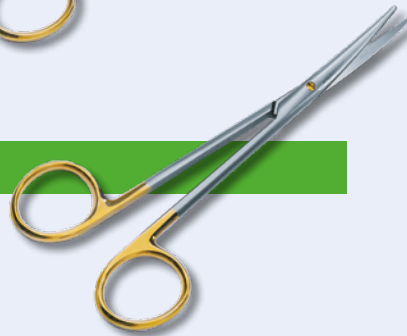
**magic cut**

Keramikbeschichtung und goldene Schraube
Ceramic coating and golden screw
Recubrimiento de cerámica y tornillo dorado
Couche céramique et vis dorée
Rivestimento di ceramica e vite dorata



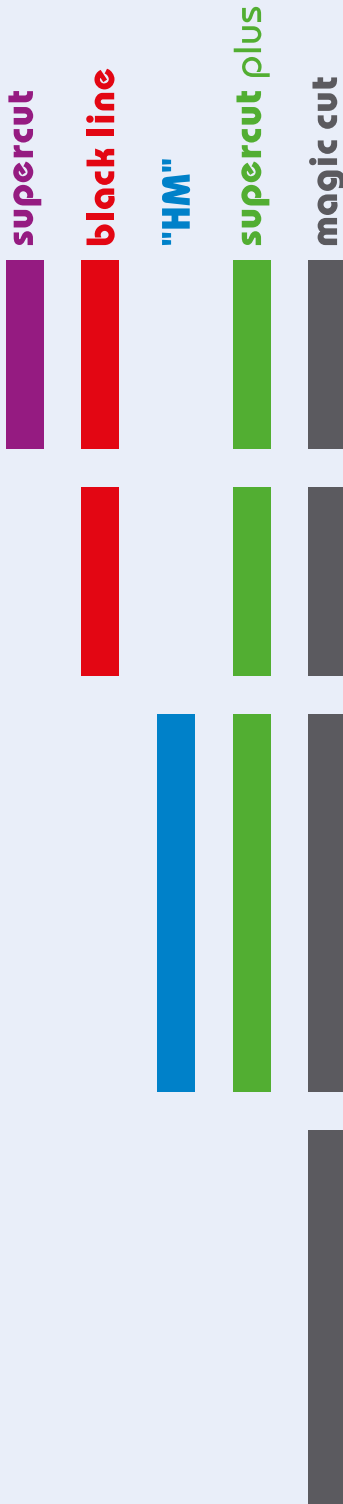

Messerschliff und Mikroverzahnung: Feiner, minimal traumatisierender Schnitt
Knife edges and micro serration: Fine, minimally traumatizing cut
Hoja de bisturí y dentadura micro: Corte fino, mínimo traumatizante
Aiguisement tranchant et dents micro: Coupe fine, peu traumatisante
Affilatura a scalpello e dentellatura micro: Taglio fine, minimamente traumatizzante

Zusätzlicher Anschlag einer Blattrückseite: Bessere Sicht · Präzise Präparation
Reduction of the transversal cut: Better visibility · Precise dissection
Reducción del corte transversal: Visión mejorada · Disección precisa
Coupe transversale réduite: Vue améliorée · Dissection précise
Riduzione del taglio trasversale: Vista migliorata · Dissezione precisa

Eingeschweißte Hartmetallschneiden: Nahtlose, homogene und korrosionsfreie Verbindung von Hartmetall und Scherenstahl
Welded tungsten carbide cutting edges: Seamless, homogenous and corrosion-free junction of tungsten carbide and scissors steel
Hojas soldadas de carburo de tungsteno: Unión sin costuras, homogénea y resistente a la corrosión del carburo de tungsteno con el acero
Lames soudées d'un alliage de carbure de tungstène: Jointure sans trace, homogène et résistante à la corrosion du carbure de tungstène avec l'acier des ciseaux
Lame saldate al carburo di tungsteno: Congiunzione senza saldature, omogenea e resistente alla corrosione del carburo di tungsteno e all'acciaio delle forbici

Keramikbeschichtung: Lange Standzeit · Hohe Oberflächenhärte · Blendfreie Oberfläche · Hervorragende Gleitfähigkeit
Ceramic coating: Long lasting cutting ability · High surface hardness · Non-dazzling surface · Excellent sliding capacity
Recubrimiento de cerámica: Máxima duración del corte · Alta dureza de la superficie · Superficie antideslumbrante · Deslizamiento destacado
Couche céramique: Longue durée de vie · Grande dureté de la surface · Surface non-éblouissante · Glissement excellent
Rivestimento di ceramica: Massima durata del taglio · Alta durezza della superficie · Superficie antiriflesso · Eccellente scorrimento



Feine Scheren
Delicate Scissors
Tijeras finas
Ciseaux délicats
Forbici delicate

A02

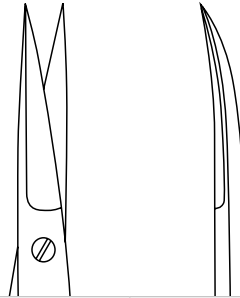

11 cm - 4 ³ / ₈ "	11 cm - 4 ³ / ₈ "	
02.06.10	02.07.10	standard
202.06.10	202.07.10	supercut
212.06.10	212.07.10	black line



Stevens

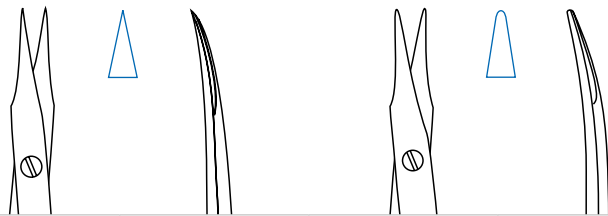

10 cm - 4"	10 cm - 4"	10 cm - 4"	10 cm - 4"	
02.50.22	02.50.23	02.50.32	02.50.33	standard



Jabaley

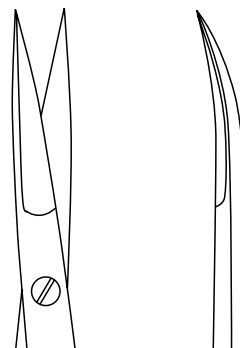

13 cm - 5 ¹ / ₈ "	13 cm - 5 ¹ / ₈ "	
02.06.13	02.07.13	standard
202.06.13	202.07.13	supercut
212.06.13	212.07.13	black line

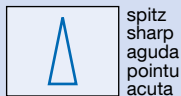

spitz
sharp
aguda
pointu
acuta



stumpf
blunt
roma
mousse
smussa

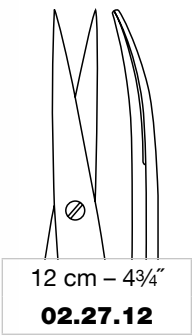

12 cm - 4¾"
02.27.12

Irisscheren
 Iris scissors
 Tijeras para iridectomía
 Ciseaux à iridectomie
 Forbici per iridectomia



Iris





9 cm - 3½"	10,5 cm - 4⅛"	11,5 cm - 4½"	12,5 cm - 5"	
02.20.09	02.20.10	02.20.11	02.20.12	standard
	202.20.10	202.20.11		supercut
	212.20.10	212.20.11		black line
		02.20.61		"HM"
		202.20.61		supercut plus
		222.20.61		magic cut

**A02**



Feine Scheren
Delicate Scissors
Tijeras finas
Ciseaux délicats
Forbici delicate

Irisscheren
 Iris scissors
 Tijeras para iridectomía
 Ciseaux à iridectomie
 Forbici per iridectomia

**Iris**

				
9 cm - 3½"	10,5 cm - 4¼"	11,5 cm - 4½"	12,5 cm - 5"	
02.21.09	02.21.10	02.21.11	02.21.12	standard
	202.21.10	202.21.11	202.21.12	supercut
	212.21.10	212.21.11		black line
		02.21.61		"HM"
		202.21.61		supercut plus
		222.21.61		magic cut

**Iris**

		
11,5 cm - 4½"	11,5 cm - 4½"	
202.22.11	202.23.11	supercut
212.22.11	212.23.11	black line
02.22.61	02.23.61	"HM"
202.22.61	202.23.61	supercut plus





Stevens

11,5 cm - 4½"	11,5 cm - 4½"	
02.50.12	02.50.13	standard
202.50.12	202.50.13	supercut
212.50.12	212.50.13	black line
222.50.62	222.50.63	magic cut

Irisscheren
 Iris scissors
 Tijeras para iridectomía
 Ciseaux à iridectomie
 Forbici per iridectomia



"BIG RING"

Iris

11,5 cm - 4½"	11,5 cm - 4½"	
212.26.11	212.27.11	black line



BIG RING
 X-Large Ring Handle



Micro-Iris

9 cm - 3½"	9 cm - 3½"	
02.20.30	02.21.30	standard
	202.21.30	supercut



A02

Feine Präparierscheren
Delicate Dissecting Scissors
Tijeras finas para disección
Ciseaux délicats pour dissection
Forbici delicate per dissezione



Lexer-Baby

10 cm - 4"	10 cm - 4"	
02.40.10	02.41.10	standard
02.40.60	02.41.60	"HM"



Knapp

12 cm - 4¾"	12 cm - 4¾"	12 cm - 4¾"	12 cm - 4¾"	
02.20.42	02.21.42	02.20.43	02.21.43	standard
202.20.42	202.21.42			supercut



Knapp

10 cm - 4"	10 cm - 4"	
02.44.10	02.45.10	standard

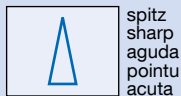

spitz
sharp
aguda
pointu
acuta



stumpf
blunt
roma
mousse
smussa

Feine Präparierscheren
Delicate Dissecting Scissors
Tijeras finas para disección
Ciseaux délicats pour dissection
Forbici delicate per dissezione

A02



Knapp

12,5 cm - 5"	12,5 cm - 5"	
02.40.11	02.41.11	standard
202.40.11	202.41.11	supercut
212.40.11	212.41.11	black line
02.40.61	02.41.61	"HM"
202.40.61	202.41.61	supercut plus
222.40.61	222.41.61	magic cut



12 cm - 4¾"	12 cm - 4¾"	
02.40.12	02.41.12	standard
202.40.12	202.41.12	supercut
212.40.12	212.41.12	black line
02.40.62	02.41.62	"HM"
202.40.62	202.41.62	supercut plus
222.40.62	222.41.62	magic cut



Stevens

13 cm - 5½"		
04.67.13	standard	
204.67.13	supercut	
214.67.13	black line	
224.67.63	magic cut	



A02

Feine Präparierscheren
Delicate Dissecting Scissors
Tijeras finas para disección
Ciseaux délicats pour dissection
Forbici delicate per dissezione



Greenberg PAR

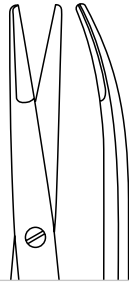

11,5 cm - 4½"	
204.13.62	supercut plus
224.13.62	magic cut



Shea

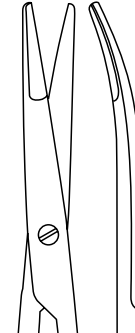

12 cm - 4¾"	
04.13.12	standard
204.13.12	supercut
214.13.12	black line



9,5 cm - 3¾"	
02.45.30	standard



Ragnell (Kilner)



13 cm - 5½"

04.13.13

204.13.13

214.13.13

04.13.63

204.13.63

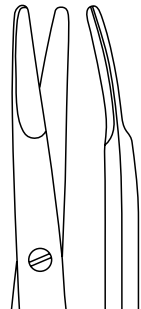

15 cm - 6"

04.13.15

204.13.15

214.13.15

04.13.65

204.13.65

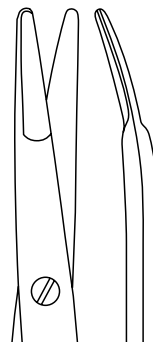

18 cm - 7½"

04.13.18

204.13.18

214.13.18

04.13.68

204.13.68

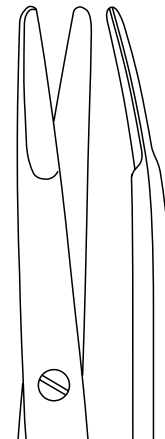

20 cm - 8"

04.13.20

				standard
				supercut
				black line
				"HM"
				supercut plus

Feine Präparierscheren
Delicate Dissecting Scissors
Tijeras finas para disección
Ciseaux délicats pour dissection
Forbici delicate per dissezione

A02



Peck-Joseph

 14 cm - 5½"	 14 cm - 5½"	 14 cm - 5½"	 14 cm - 5½"	
204.14.15	204.15.15	204.16.15	204.17.15	supercut
214.14.15	214.15.15	214.16.15	214.17.15	black line

Unterminierscheren
 Tunneling scissors
 Tijeras para tunelización
 Ciseaux à tunnellation
 Forbici per tunnelizzazione



Siegert

 11,5 cm - 4½"	 11,5 cm - 4½"	
204.10.11	204.11.11	supercut
04.10.61	04.11.61	"HM"
224.10.61	224.11.61	magic cut



Joseph

 15 cm - 6"	 15 cm - 6"	
04.50.15	04.51.15	standard
204.50.15	204.51.15	supercut
214.50.15	214.51.15	black line



spitz
 sharp
 aguda
 pointu
 acuta



stumpf
 blunt
 roma
 mousse
 smussa

**A02**

Feine Präparierscheren
Delicate Dissecting Scissors
Tijeras finas para disección
Ciseaux délicats pour dissection
Forbici delicate per dissezione

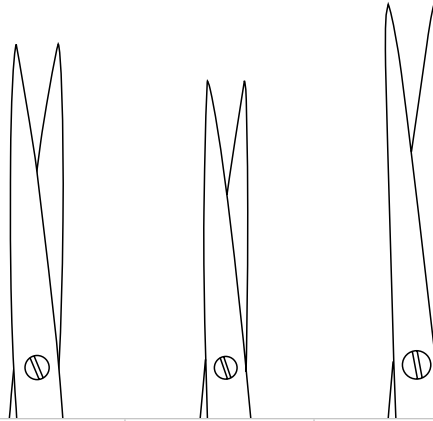
**"slim"**

14 cm - 5½"	18 cm - 7⅛"	20 cm - 8"	
04.24.14	04.24.18	04.24.20	standard
204.24.14			supercut
04.24.64			"HM"
204.24.64			supercut plus

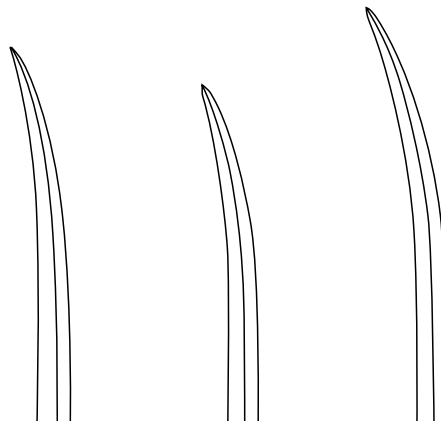
**"slim"**

14 cm - 5½"	18 cm - 7⅛"	20 cm - 8"	
04.25.14	04.25.18	04.25.20	standard
204.25.14	204.25.18		supercut
04.25.64			"HM"
204.25.64			supercut plus



Feine Präparierscheren
Delicate Dissecting Scissors
Tijeras finas para disección
Ciseaux délicats pour dissection
Forbici delicate per dissezione

A02



Baby-Metzenbaum

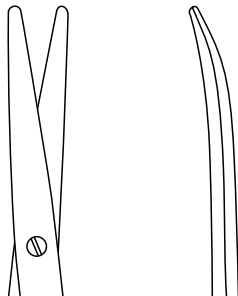

11,5 cm - 4½"	11,5 cm - 4½"	
214.36.11	214.37.11	black line



BIG RING
X-Large Ring Handle



Stevens

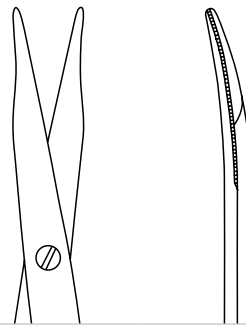

12,5 cm - 5"	12,5 cm - 5"	
214.68.13	214.69.13	black line



Jameson

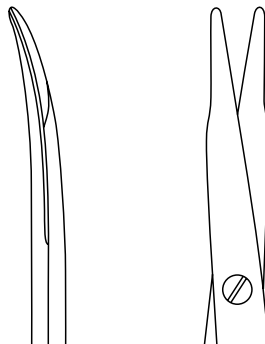

15 cm - 6"	18 cm - 7½"	
204.67.17	204.68.18	supercut
214.67.17	214.68.18	black line

**A02**

Feine Präparierscheren
Delicate Dissecting Scissors
Tijeras finas para disección
Ciseaux délicats pour dissection
Forbici delicate per dissezione

21
20
19
18
17
16
15
14
13
12
11
10
9
8
7
6
5
4
3
2
1
cm | inch

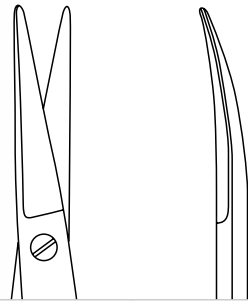
**Brüser-Kelly**

16 cm - 6¼"	16 cm - 6¼"	
204.56.16	204.57.16	supercut

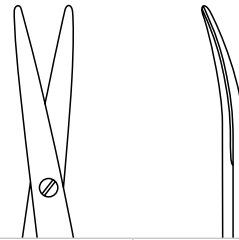
**Mini-Metzenbaum**

9 cm - 3½"	9 cm - 3½"	
204.32.09	204.33.09	supercut
214.32.09	214.33.09	black line

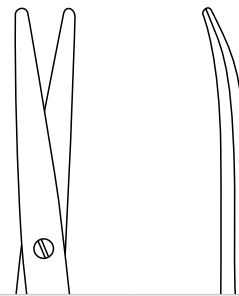
**Baby-Metzenbaum**

11,5 cm - 4½"	11,5 cm - 4½"	
04.32.11	04.33.11	standard
204.32.11	204.33.11	supercut
214.32.11	214.33.11	black line
04.32.61	04.33.61	"HM"
204.32.61	204.33.61	supercut plus
224.32.61	224.33.61	magic cut

**Präparierscheren
Dissecting Scissors
Tijeras para disección
Ciseaux pour dissection
Forbici per dissezione**

A02



**203.51.67
Mayo supercut plus**

Zum Schneiden von Knorpel
For cartilage cutting
Para cortar cartílagos
Pour couper le cartilage
Per tagliare cartilagine



Mayo

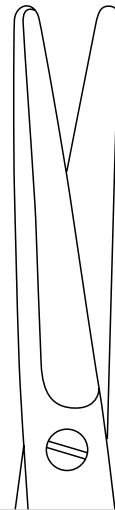
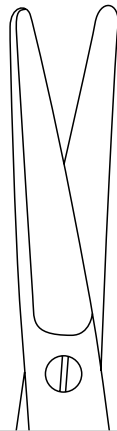

14,5 cm - 5¾"	14,5 cm - 5¾"	17 cm - 6¾"	17 cm - 6¾"	
03.50.14	03.51.14	03.50.17	03.51.17	standard
203.50.14	203.51.14	203.50.17	203.51.17	supercut
213.50.14	213.51.14	213.50.17	213.51.17	black line
03.50.64	03.51.64	03.50.67	03.51.67	"HM"
203.50.64	203.51.64	203.50.67	203.51.67	supercut plus
223.50.64	223.51.64	223.50.67	223.51.67	magic cut



A02

Präparierscheren
Dissecting Scissors
Tijeras para disección
Ciseaux pour dissection
Forbici per dissezione



Mayo-Lexer



16,5 cm - 6½"	
203.57.47	supercut
213.57.47	black line
03.57.97	"HM"
203.57.97	supercut plus
223.57.97	magic cut



Lexer



16 cm - 6¼"	16 cm - 6¼"	
03.56.86	03.57.86	standard
203.56.86	203.57.86	supercut
213.56.86	213.57.86	black line
03.56.96	03.57.96	"HM"
203.56.96	203.57.96	supercut plus
223.56.96	223.57.96	magic cut

**Präparierscheren
Dissecting Scissors
Tijeras para disección
Ciseaux pour dissection
Forbici per dissezione**

A02



**03.57.67
Mayo-Style "HM"**

Für präzises, druckloses Gipsschneiden direkt auf der Nase ohne Verschiebung des mobilisierten Nasengerüsts.

For precise, pressure-free plaster cutting directly on the nose without displacement of the mobilized nose framework.

Para el corte preciso y sin presión del yeso directamente sobre la nariz y sin desplazamiento del armazón de la nariz movilizado.

Pour une coupe précise et sans pression du plâtre directement sur le nez, sans décalage de la charpente nasale mobilisée.

Per tagliare con precisione il gesso direttamente sul naso senza esercitare pressione e senza spostare la struttura nasale mobile.



Mayo-Style

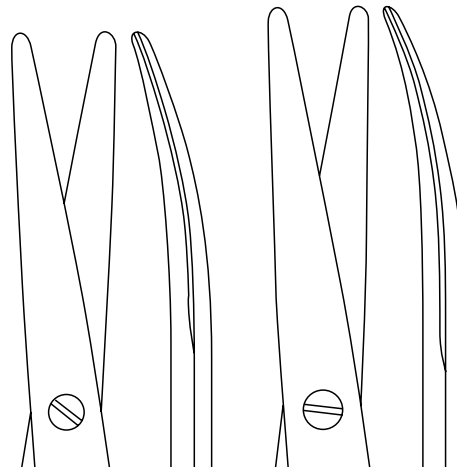

15 cm - 6"	17 cm - 6¾"	
03.57.15	03.57.17	standard
203.57.15	203.57.17	supercut
213.57.15	213.57.17	black line
03.57.65	03.57.67	"HM"
203.57.65	203.57.67	supercut plus
223.57.65	223.57.67	magic cut

**A02**

Präparierscheren
Dissecting Scissors
Tijeras para disección
Ciseaux pour dissection
Forbici per dissezione

**Metzenbaum**

14 cm - 5½"	18 cm - 7⅛"	20 cm - 8"	
04.32.14	04.32.18	04.32.20	standard
204.32.14	204.32.18	204.32.20	supercut
214.32.14	214.32.18	214.32.20	black line
04.32.64	04.32.68	04.32.70	"HM"
204.32.64	204.32.68	204.32.70	supercut plus
224.32.64	224.32.68	224.32.70	magic cut

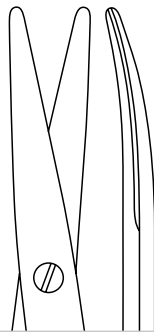
**Metzenbaum**

14 cm - 5½"	
204.33.13	supercut
214.33.13	black line
04.33.63	"HM"
204.33.63	supercut plus
224.33.63	magic cut



**Präparierscheren
Dissecting Scissors
Tijeras para disección
Ciseaux pour dissection
Forbici per dissezione**

A02



204.33.68

Metzenbaum *supercut plus*

Besonders geeignet zum Luxieren der Nasenflügelknorpel.
Particularly well suited for dislocation of the lower nasal cartilages.
Especialmente adecuado para la luxación de los cartilagos de las alas de la nariz.
Convient en particulier pour luxer le cartilage des ailes du nez.
Particolarmente adatto per la lussazione delle cartilagini alari del naso.



Metzenbaum

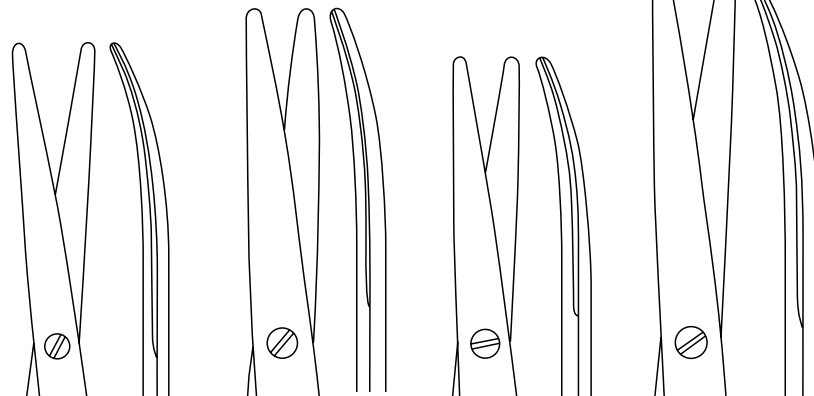

14 cm - 5½"	15 cm - 6"	18 cm - 7⅛"	20 cm - 8"	
04.33.14	04.33.15	04.33.18	04.33.20	standard
204.33.14	204.33.15	204.33.18	204.33.20	supercut
214.33.14	214.33.15	214.33.18	214.33.20	black line
04.33.64		04.33.68	04.33.70	"HM"
204.33.64		204.33.68	204.33.70	supercut plus
224.33.64		224.33.68	224.33.70	magic cut

**A02**

Präparierscheren
Dissecting Scissors
Tijeras para disección
Ciseaux pour dissection
Forbici per dissezione

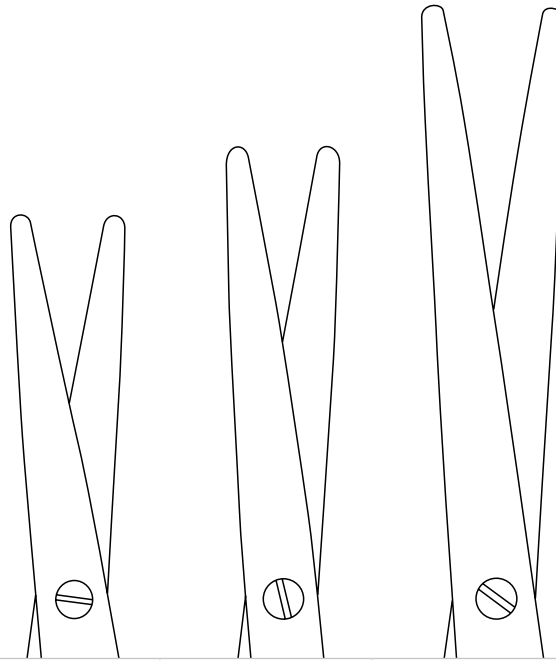
**Nelson-Metzenbaum**

23 cm - 9"	26 cm - 10¼"	30 cm - 11¾"	
04.32.23	04.32.26	04.32.30	standard
204.32.23	204.32.26	204.32.30	supercut
214.32.23	214.32.26	214.32.30	black line
04.32.73			"HM"
204.32.73			supercut plus
224.32.73			magic cut





Nelson-Metzenbaum

	23 cm - 9"	26 cm - 10¼"	30 cm - 11¾"	
	04.33.23	04.33.26	04.33.30	standard
	204.33.23	204.33.26	204.33.30	supercut
	214.33.23	214.33.26	214.33.30	black line
	04.33.73	04.33.76	04.33.80	"HM"
	204.33.73	204.33.76	204.33.80	supercut plus
	224.33.73		224.33.80	magic cut

**A02**

Präparierscheren
Dissecting Scissors
Tijeras para disección
Ciseaux pour dissection
Forbici per dissezione

**Metzenbaum-slim**

14 cm - 5½"	18 cm - 7⅛"	20 cm - 8"	23 cm - 9"	
04.34.14	04.34.18	04.34.20	04.34.23	standard
204.34.14	204.34.18	204.34.20	204.34.23	supercut
214.34.14	214.34.18	214.34.20	214.34.23	black line
04.34.64	04.34.68	04.34.70	04.34.73	"HM"
204.34.64	204.34.68	204.34.70	204.34.73	supercut plus

**Metzenbaum-slim**

14 cm - 5½"	18 cm - 7⅛"	20 cm - 8"	23 cm - 9"	
04.35.14	04.35.18	04.35.20	04.35.23	standard
204.35.14	204.35.18	204.35.20	204.35.23	supercut
214.35.14	214.35.18	214.35.20	214.35.23	black line
04.35.64	04.35.68	04.35.70	04.35.73	"HM"
204.35.64	204.35.68	204.35.70	204.35.73	supercut plus
224.35.64	224.35.68	224.35.70	224.35.73	magic cut



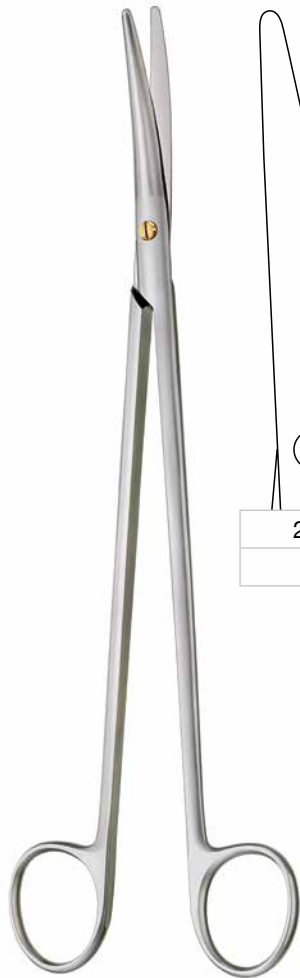

Metzenbaum-slim

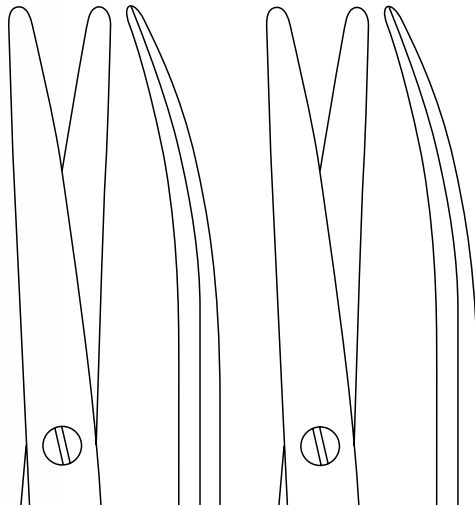

26 cm - 10¼"	28,5 cm - 11¼"	
204.35.26	204.35.28	supercut



Toennis-Adson



18 cm - 7⅛"	
04.63.18	standard
204.63.18	supercut
214.63.18	black line
04.63.68	"HM"
204.63.68	supercut plus
224.63.68	magic cut



A02

Präparierscheren
Dissecting Scissors
Tijeras para disección
Ciseaux pour dissection
Forbici per dissezione

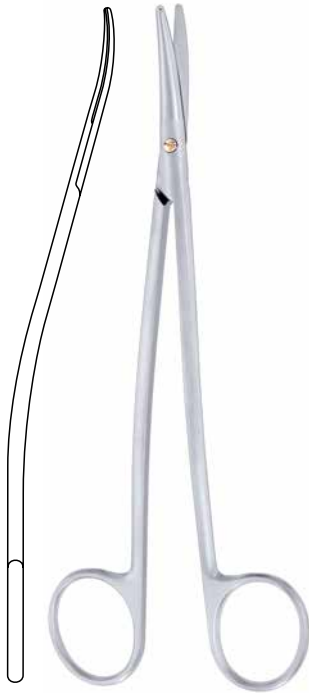

Metzenbaum

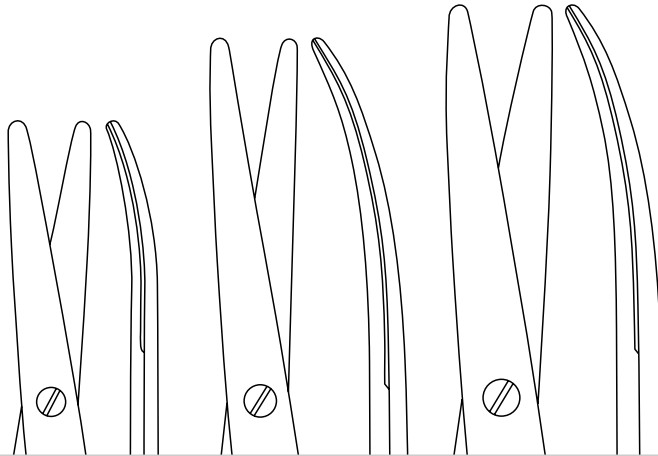

18 cm - 7 1/8"	20 cm - 8"	23 cm - 9"	
204.36.18	204.36.20	204.36.23	supercut
214.36.18	214.36.20	214.36.23	black line
04.36.68	04.36.70	04.36.73	"HM"
204.36.68	204.36.70	204.36.73	supercut plus



Metzenbaum-Freeman

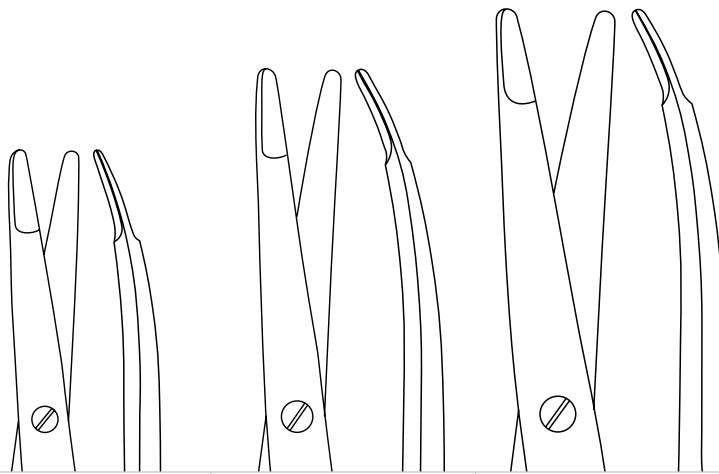

18 cm - 7 1/8"	20 cm - 8"	23 cm - 9"	
204.37.18	204.37.20	204.37.23	supercut
214.37.18	214.37.20	214.37.23	black line

Präparierscheren
Dissecting Scissors
Tijeras para disección
Ciseaux pour dissection
Forbici per dissezione

A02



15,5 cm - 6 1/8"	
214.52.15	black line

Daniel

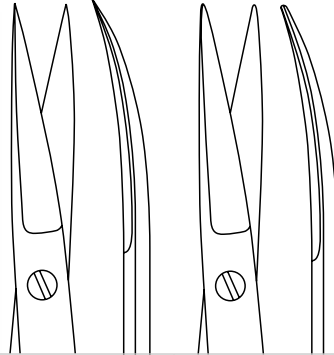

15 cm - 6"	15 cm - 6"	
214.53.15	214.53.16	black line



Joseph-Daniel



16 cm - 6 1/4"	16 cm - 6 1/4"	
04.54.16	04.55.16	standard
204.54.16	204.55.16	supercut
214.54.16	214.55.16	black line
04.54.66	04.55.66	"HM"
204.54.66	204.55.66	supercut plus
224.54.66	224.55.66	magic cut

Kelly



spitz
sharp
aguda
pointu
acuta



stumpf
blunt
roma
mousse
smussa



A02

Präparierscheren
Dissecting Scissors
Tijeras para disección
Ciseaux pour dissection
Forbici per dissezione



Reynolds (Jameson)

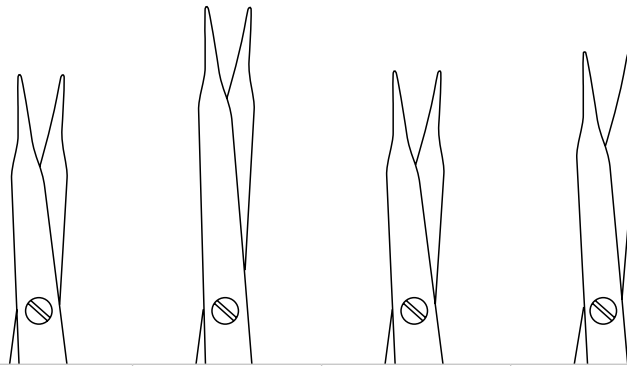

12 cm - 4¾"	14 cm - 5½"	16 cm - 6¼"	18 cm - 7⅛"	
04.66.12	04.66.14	04.66.16	04.66.18	standard



Reynolds (Jameson)

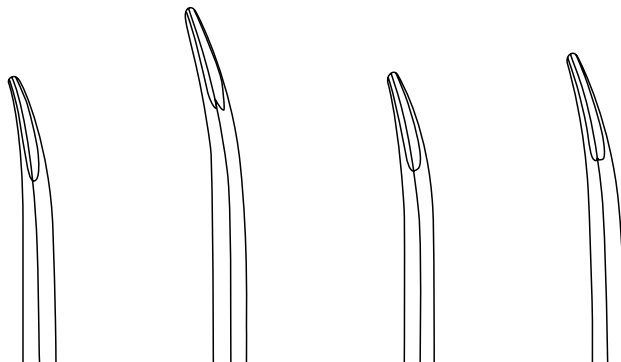

12 cm - 4¾"	14 cm - 5½"	16 cm - 6¼"	18 cm - 7⅛"	
04.67.12	04.67.14	04.67.16	04.67.18	standard
204.67.12		204.67.16	204.67.18	supercut
214.67.12		214.67.16	214.67.18	black line
		224.67.66	224.67.68	magic cut



stumpf
 blunt
 roma
 mousse
 smussa

Unterminierscheren
 Tunneling scissors
 Tijeras para tunelización
 Ciseaux à tunnellation
 Forbici per tunnelizzazione



Fanous

16,5 cm - 6½"	16,5 cm - 6½"	20,5 cm - 8"	20,5 cm - 8"	
204.68.16	204.69.16	204.68.20	204.69.20	supercut

Blepharoplastikscheren
 Blepharoplasty scissors
 Tijeras para blefaroplastia
 Ciseaux pour bléfaroplastie
 Forbici per blefaroplastica



Kaye

11,5 cm - 4½"	
204.77.12	supercut
214.77.12	black line



A02

Präparierscheren
Dissecting Scissors
Tijeras para disección
Ciseaux pour dissection
Forbici per dissezione

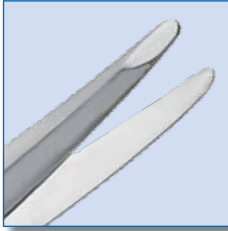

flache Spitzen
 flat tips
 puntas planas
 pointes plates
 punte piatte



Gorney

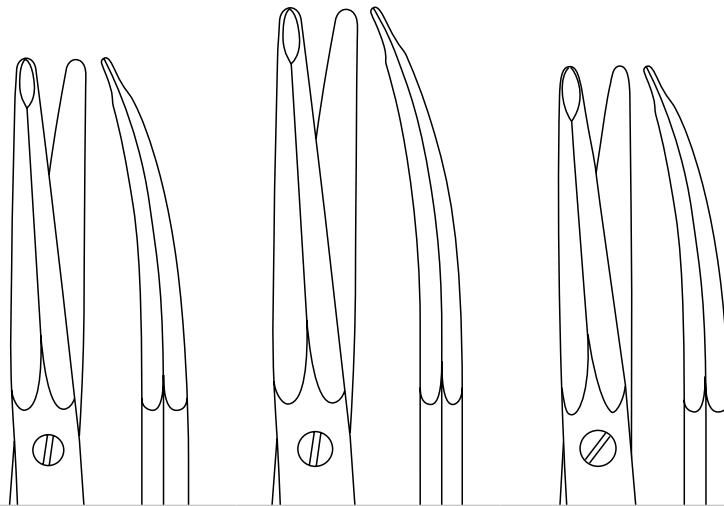

17 cm - 6¾"	19 cm - 7½"	23 cm - 9"	
204.73.17	204.73.19	204.73.23	supercut
214.73.17	214.73.19	214.73.23	black line
04.73.67	04.73.69	04.73.73	"HM"
224.73.67	224.73.69	224.73.73	magic cut



Mammoplasty
 Facelift
 Abdominoplasty



flache Spitzen
 flat tips
 puntas planas
 pointes plates
 punte piatte

**Präparierscheren
Dissecting Scissors
Tijeras para disección
Ciseaux pour dissection
Forbici per dissezione**

A02



Gorney-Freeman

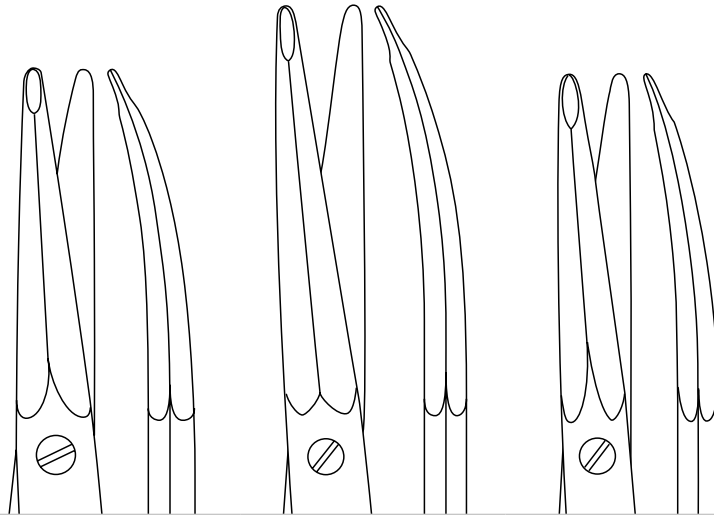

17 cm - 6¾"	19 cm - 7½"	23 cm - 9"	
204.75.17	204.75.19	204.75.23	supercut
214.75.17	214.75.19	214.75.23	black line
04.75.67	04.75.69	04.75.73	"HM"
224.75.67	224.75.69	224.75.73	magic cut



Mammoplasty
Facelift
Abdominoplasty

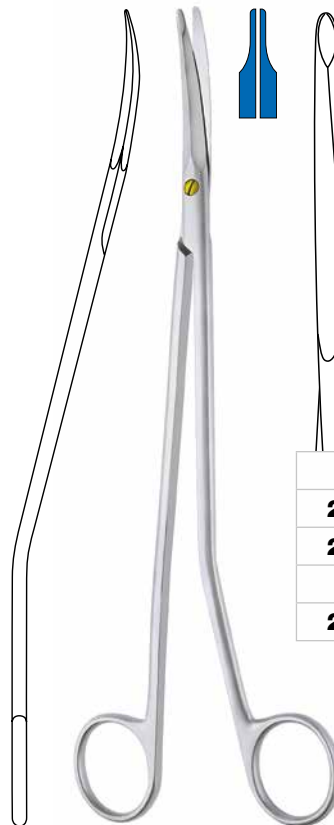

Gorney-Freeman

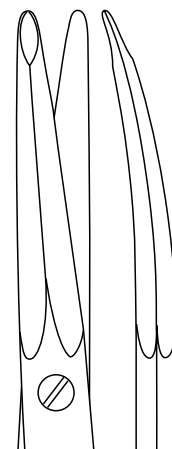

23 cm - 9"	
204.75.22	supercut
214.75.22	black line
04.75.72	"HM"
224.75.72	magic cut

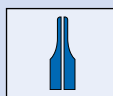

flache Spitzen
flat tips
puntas planas
pointes plates
punte piatte



A02

**Präparierscheren
Dissecting Scissors
Tijeras para disección
Ciseaux pour dissection
Forbici per dissezione**

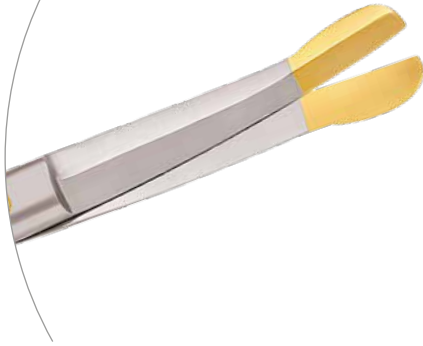

**214.79.20
Solz "GOLD TIP"**

Die besondere Form der Schneidespitzen ermöglicht eine optimale, atraumatische Trennung der Gewebeschichten.

The special design of the cutting tips enables an ideal and atraumatic separation of the different tissue layers.

La forma especial de las partes delanteras del filo posibilita una separación ideal y atraumática de las diferentes capas de tejido.

La forme spéciale de l'embout des lames permet une séparation optimale et non-traumatisante du tissu.

La forma speciale delle punte delle lame rende possibile una separazione ottima ed atraumatica degli strati di tessuto.



Solz

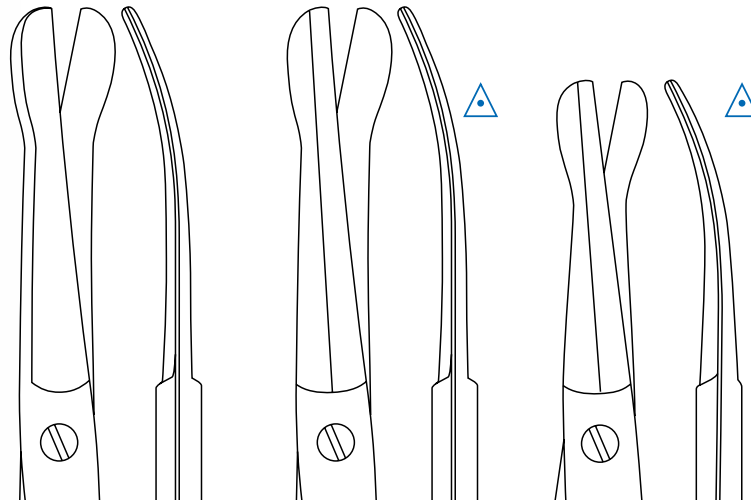

20 cm - 8"	20 cm - 8"	15 cm - 6"	
204.79.20	214.79.20	214.79.15	supercut



Mammoplasty
Facelift
Abdominoplasty



Außenkanten halb-scharf
Outer edges semisharp
Bordes extérieurs semicortantes
Bordi esterni semitaglienti



**Präparierscheren
Dissecting Scissors
Tijeras para disección
Ciseaux pour dissection
Forbici per dissezione**

A02



Kaye

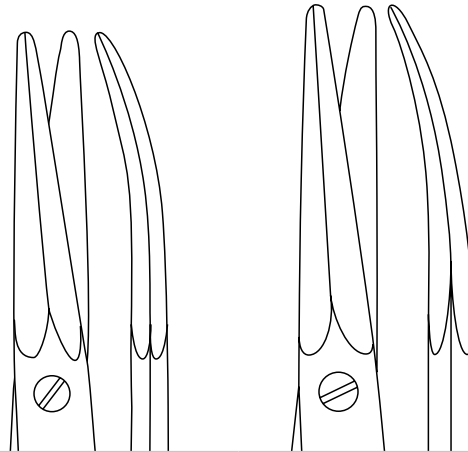

15 cm - 6"	17 cm - 6¾"	
204.77.15	204.77.17	supercut
214.77.15	214.77.17	black line
	04.77.67	"HM"
	224.77.67	magic cut



Kaye

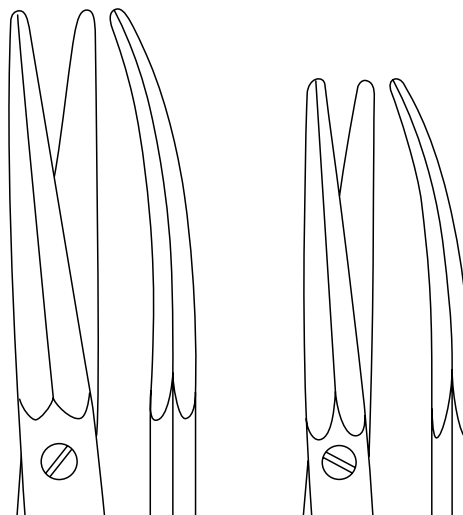



19 cm - 7½"	23 cm - 9"	
204.77.19	204.77.23	supercut
214.77.19	214.77.23	black line
04.77.69	04.77.73	"HM"
224.77.69	224.77.73	magic cut



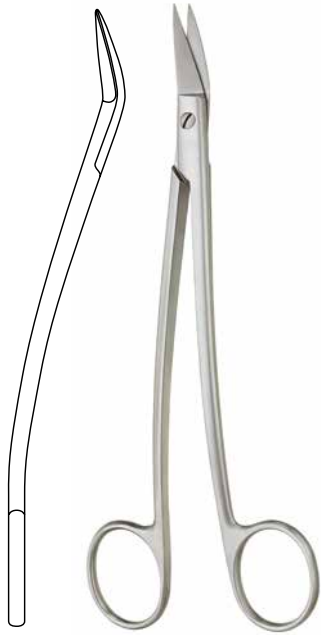
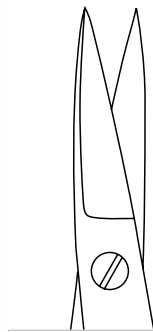

**A02**

Zahnfleischscheren
Gum Scissors
Tijeras para encías
Ciseaux pour gencive
Forbici per gengiva

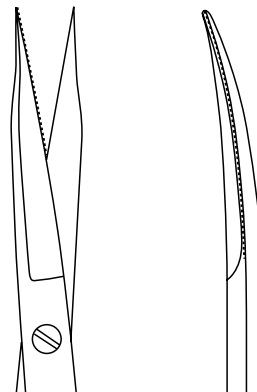
**Dean**

17 cm - 6¾"	
72.45.50	standard 
272.45.50	supercut 
282.45.50	black line 

**Fox**

13 cm - 5⅛"	13 cm - 5⅛"	
04.80.13	04.81.13	standard 
204.80.13	204.81.13	supercut 
214.80.13	214.81.13	black line 
04.80.63	04.81.63	"HM" 
204.80.63	204.81.63	supercut plus 



Eine Schneide gezahnt
 One blade serrated
 Una hoja dentada
 Une lame dentelée
 Una lama dentellata



micro 2000



12,5 cm - 5"	12,5 cm - 5"	
05.12.20	05.12.21	standard
205.12.20	205.12.21	supercut



- geringes Gewicht
- gut ausbalanciert
- ermüdungsfreies Arbeiten

- extremely light weight
- well balanced
- fatigueless utilization

- peso muy ligero
- bien equilibrados
- trabajo sin fatiga

- poids léger
- bien équilibrés
- travail sans fatigue

- peso minimo
- equilibrio perfetto
- non affaticano la mano



micro 2000

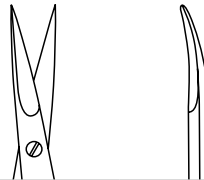

15 cm - 6"	15 cm - 6"	
05.15.20	05.15.21	standard
205.15.20	205.15.21	supercut



Koshima



14 cm - 5½"
05.12.32

VANNAS

- Mikroscheren für extrem kleine und feine Blutgefäße
- Micro scissors for extremely small and fine blood vessels
- Tijeras micro para vasos sanguíneos extremadamente pequeños y finos
- Ciseaux micro pour des vaisseaux sanguins extrêmement petits et fins
- Forbici chirurgiche per vasi sanguigni molto piccoli e fini



Koshima



14 cm - 5½"
05.12.34

VANNAS



Vannas-Schneiden
 Vannas-type cutting edges
 Hojas según Vannas
 Lames selon Vannas
 Lame secondo Vannas



Mikro Scheren
Micro Scissors
Micro tijeras
Micro ciseaux
Micro forbici

A02



micro 2000



VANNAS

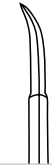

15 cm - 6"	15 cm - 6"	15 cm - 6"	15 cm - 6"	
05.15.22	05.15.23	05.15.30	05.15.31	standard

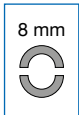

VANNAS

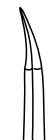

15 cm - 6"	15 cm - 6"	15 cm - 6"	15 cm - 6"	
05.15.74	05.15.75	05.15.76	05.15.77	standard
205.15.74				supercut



Rundgriff
Round handle
Mango redondo
Manche rond
Manico rotondo







Eine Schneide gezahnt
One blade serrated
Una hoja dentada
Une lame dentelée
Una lama dentellata



Vannas-Schneiden
Vannas-type cutting edges
Hojas según Vannas
Lames selon Vannas
Lame secondo Vannas



**Jacobson
 micro 2000**

				
18 cm - 7 1/8"	18 cm - 7 1/8"	18 cm - 7 1/8"	18 cm - 7 1/8"	
05.18.20	05.18.21	05.18.25	05.18.26	standard



23 cm - 9"	
05.19.02	standard

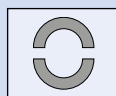

Rundgriff
 Round handle
 Mango redondo
 Manche rond
 Manico rotondo



Mikro Scheren
Micro Scissors
Micro tijeras
Micro ciseaux
Micro forbici

A02



micro 2000

15 cm - 6"	15 cm - 6"	18 cm - 7 1/8"	18 cm - 7 1/8"	
05.15.70	05.15.71	05.18.70	05.18.71	standard
		205.18.70	205.18.71	supercut

15 cm - 6"	15 cm - 6"	18 cm - 7 1/8"	18 cm - 7 1/8"	
05.15.72	05.15.73	05.18.72	05.18.73	standard

15 cm - 6"	15 cm - 6"	18 cm - 7 1/8"	18 cm - 7 1/8"	
05.15.81	05.15.83	05.18.81	05.18.83	standard



Instrumente mit blau eloxierten Leichtmetall-Griffen für höchste Präzision und Arbeitskomfort.

Instruments with blue anodized light metal handles for maximum precision and working convenience.

Instrumentos con mangos de metal ligero anodizados en azul para la precisión y el confort de trabajo máximo.

Instruments avec manches en métal léger anodisés en bleu pour un maximum de précision et de confort à l'utilisation.

Strumenti con manici di metallo leggero anodizzati blu per una precisione massima e conforto lavorativo.



Eine Schneide gezahnt
 One blade serrated
 Una hoja dentada
 Une lame dentelée
 Una lama dentellata



spitz
 sharp
 aguda
 pointu
 acuta



stumpf
 blunt
 roma
 mousse
 smussa

Ti
 8 mm

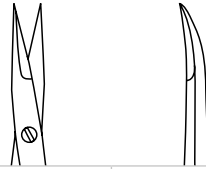

15 cm - 6"	15 cm - 6"	
05.16.74	05.16.75	standard

18 cm - 7 1/8"	18 cm - 7 1/8"	
05.18.74	05.18.75	standard

21 cm - 8 1/4"	21 cm - 8 1/4"	
05.21.74	05.21.75	standard

Ti

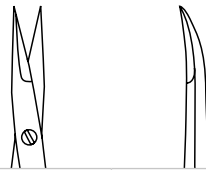

15 cm - 6"	15 cm - 6"	
05.16.68	05.16.69	standard

18 cm - 7 1/8"	18 cm - 7 1/8"	
05.18.68	05.18.69	standard

21 cm - 8 1/4"	21 cm - 8 1/4"	
05.21.68	05.21.69	standard

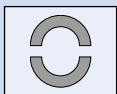

Rundgriff
 Round handle
 Mango redondo
 Manche rond
 Manico rotondo



Titan
 Titanium
 Titanio
 Titane
 Titanio



A02

Ligaturscheren
Ligature Scissors
Tijeras para ligaduras
Ciseaux à ligature
Forbici per legature



mit Mikroverzahnung und Hartmetallschneiden
with micro serration and tungsten carbide edges
con dentado micro y hojas de carburo tungsteno
avec denture micro et lames en carbure de tungstène
con dentellatura micro e lame in carburo tungsteno



"HM"

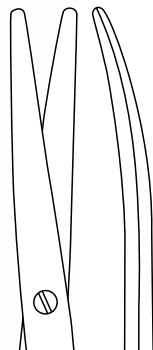

14,5 cm - 5¾"
14.06.84

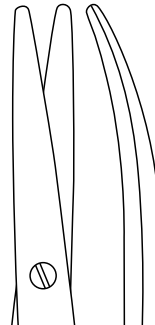

18 cm - 7½"
14.06.88

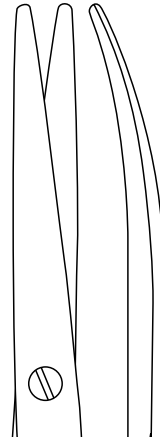

23 cm - 9"
14.06.93



"HM"

Hartmetall
Tungsten carbide
Carburo de tungsteno
Carbure de tungstène
Carburo di tungsteno

**Chirurgische Schere, Fadenscheren
Operating Scissors, Stitch Scissors
Tijera quirúrgica, Tijeras para hilos
Ciseaux chirurgical, Ciseaux à fils
Forbice chirurgice, Forbici taglia-fili**

A02

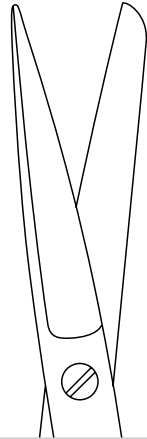

13 cm - 5 1/8"
03.06.13

Fadenscheren
Stitch scissors
Tijeras para hilos
Ciseaux à fils
Forbici taglia-fili



Spencer

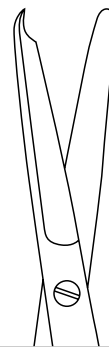

9 cm - 3 1/2"	10,5 cm - 4 1/8"	12 cm - 4 3/4"	
14.06.09	14.06.10	14.06.12	standard
	14.06.60	14.06.62	"HM"



A02

Fadenscheren
Stitch Scissors
Tijeras para hilos
Ciseaux à fils
Forbici taglia-fili



Littauer

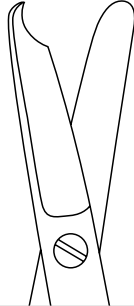

13 cm - 5 1/8"	
14.06.13	standard



Kelly



15 cm - 6"	
14.06.15	standard



O'Brien



9 cm - 3 1/2"	
14.07.09	standard

Feine Pinzetten, anatomisch und chirurgisch
Delicate Forceps, dressing and tissue
Pinzas finas, anatómicas y quirúrgicas
Pinces délicates, anatomiques et chirurgicales
Pinze delicate, anatomiche e chirurgiche

A03



14,5 cm - 5¾"
06.07.14

Hudson-Ewald



12,5 cm - 5"
06.20.01

Hudson-Ewald



12,5 cm - 5"
06.20.05

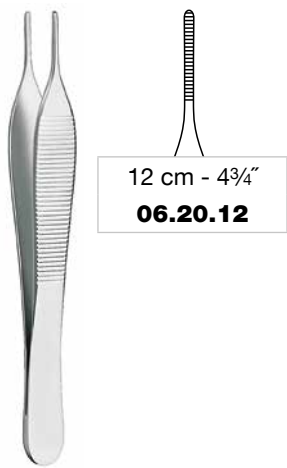

12 cm - 4¾"
06.20.12

Adson



12 cm - 4¾"
06.20.62

Adson "HM"



15 cm - 6"
06.20.65

Adson "HM"

"HM"
 Hartmetall
 Tungsten carbide
 Carburo de tungsteno
 Carbure de tungstène
 Carburo di tungsteno



A03

Feine Pinzetten, anatomisch und chirurgisch
Delicate Forceps, dressing and tissue
Pinzas finas, anatómicas y quirúrgicas
Pinces délicates, anatomiques et chirurgicales
Pinze delicate, anatomiche e chirurgiche

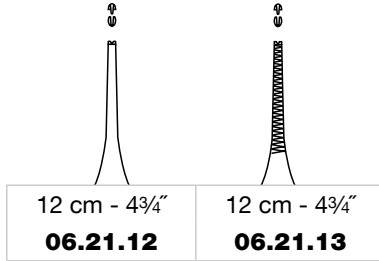

Adson

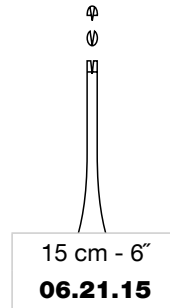

Adson

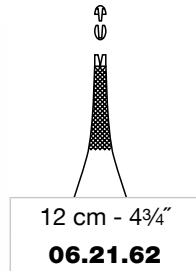

Adson "HM"

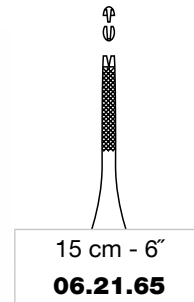

Adson "HM"

"HM"
 Hartmetall
 Tungsten carbide
 Carburo de tungsteno
 Carbure de tungstène
 Carburo di tungsteno

Feine Pinzetten, chirurgisch
Delicate Forceps, tissue
Pinzas finas, quirúrgicas
Pinces délicates, chirurgicales
Pinze delicate, chirurgiche

A03

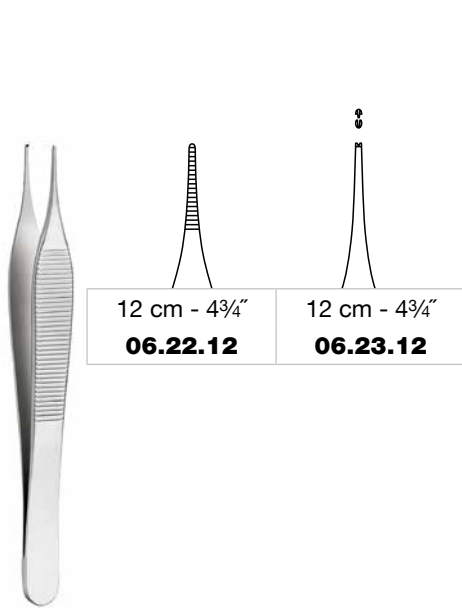

Micro-Adson

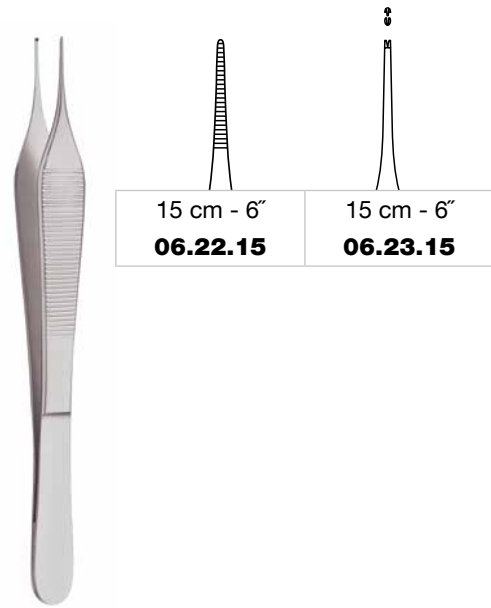

Micro-Adson

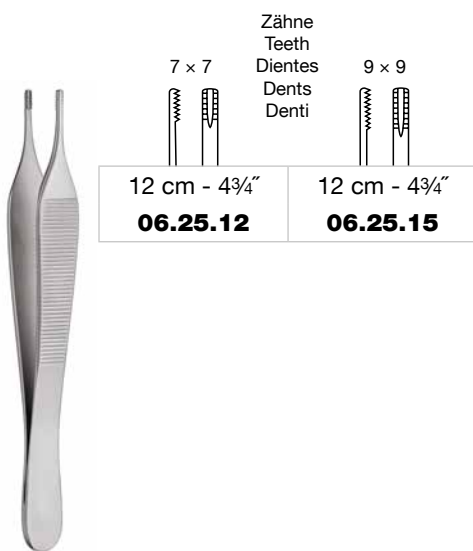

Adson-Brown

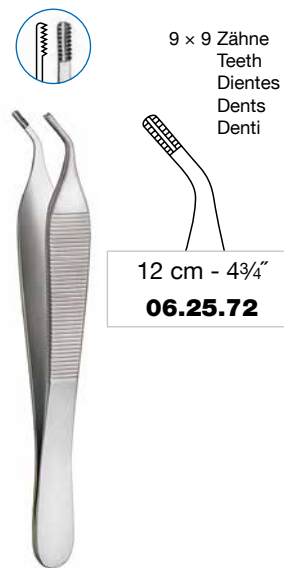

Adson-Brown



Adson-Graefe



Feine Pinzetten, anatomisch und chirurgisch
Delicate Forceps, dressing and tissue
Pinzas finas, anatómicas y quirúrgicas
Pinces délicates, anatomiques et chirurgicales
Pinze delicate, anatomiche e chirurgiche

A03



Semken

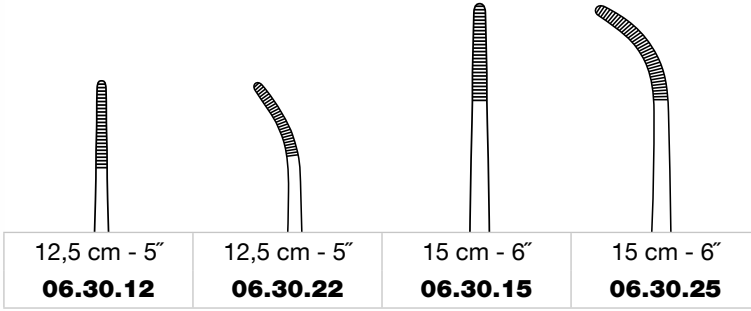

Semken

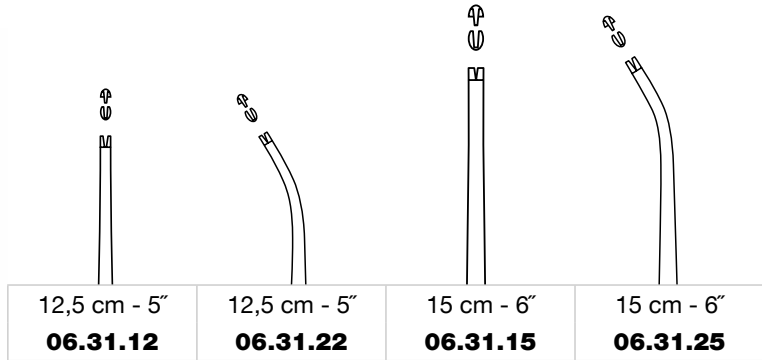

Semken

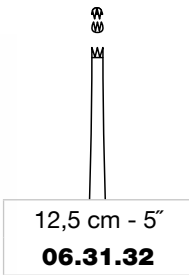

McIndoe

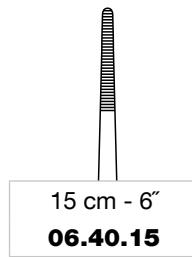

Gillies

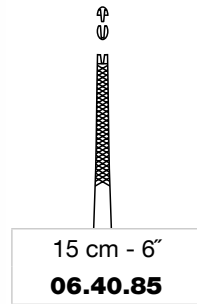

Pinzetten, anatomisch und chirurgisch
Forceps, dressing and tissue
Pinzas, anatómicas y quirúrgicas
Pinces, anatomiques et chirurgicales
Pinze, anatomiche e chirurgiche

A03

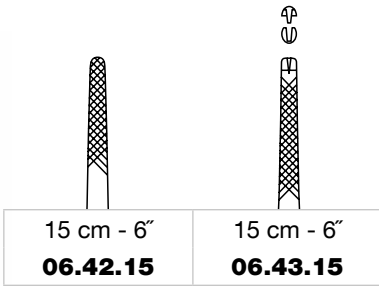

Waugh

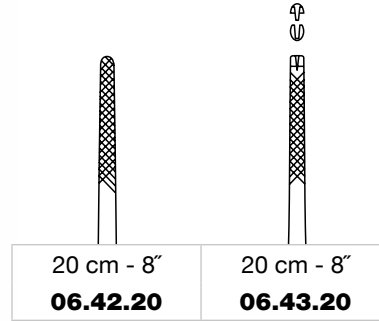

Waugh

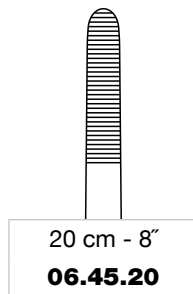





A03

Mikro Pinzetten
Micro Forceps
Micro pinzas
Micro pincers
Micro Pinze



	0,2 mm	0,3 mm		0,2 mm	0,3 mm
	10,5 cm - 4 1/8"	10,5 cm - 4 1/8"		12 cm - 4 3/4"	12 cm - 4 3/4"
micro 2000	07.61.05	07.61.06	micro 2000	07.61.07	07.61.08
	0,2 mm	0,3 mm	0,2 mm	0,3 mm	
	12,5 cm - 5"	12,5 cm - 5"	13,5 cm - 5 3/8"	13,5 cm - 5 3/8"	
micro 2000	07.61.11	07.61.12	07.61.13	07.61.14	



spitz
sharp
aguda
pointu
acuta



stumpf
blunt
roma
mousse
smussa

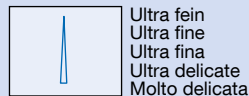
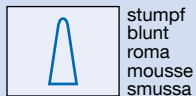
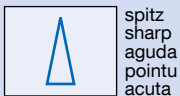
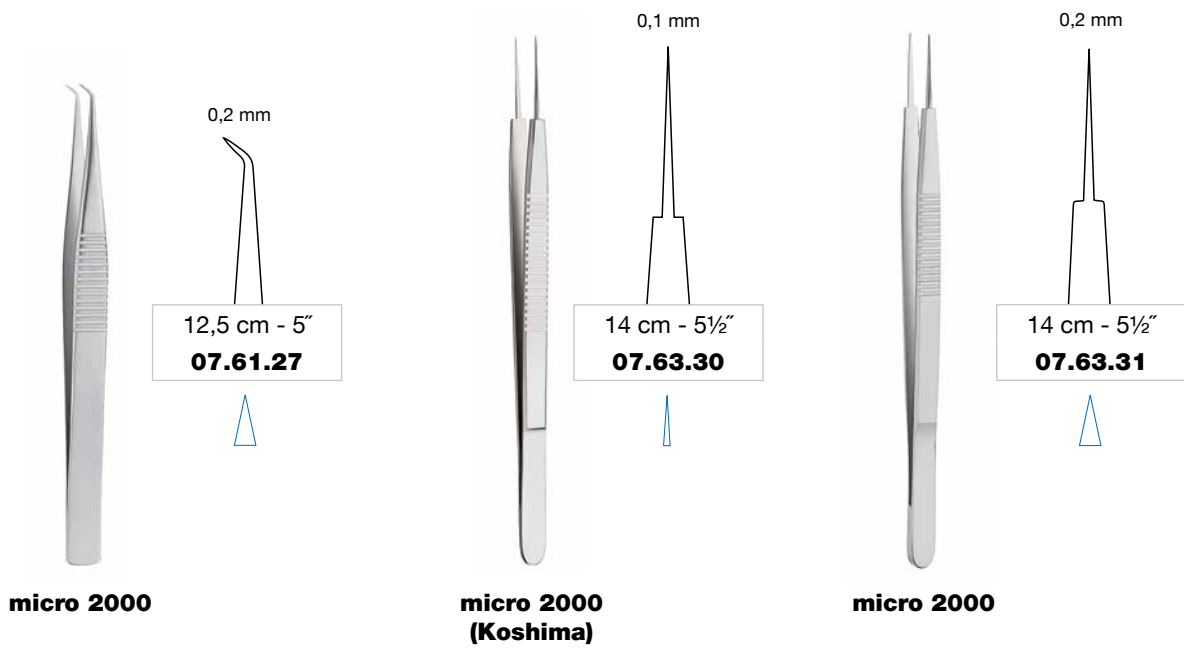
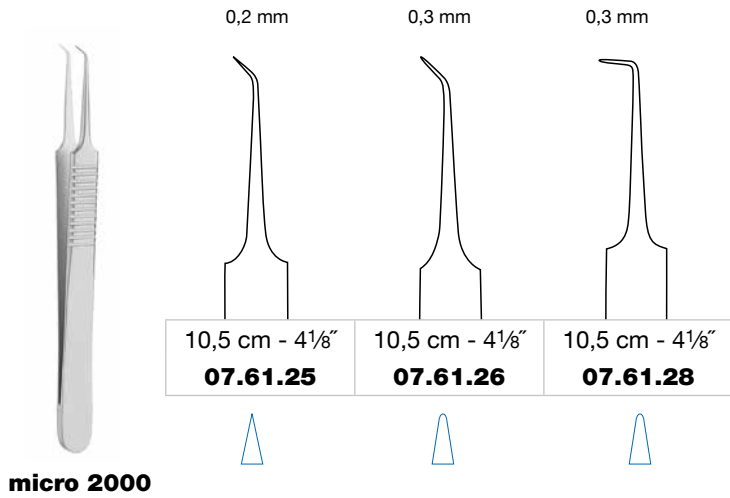



Mikro Pinzetten
Micro Forceps
Micro pinzas
Micro pinces
Micro Pinze

A03



micro 2000

0,2 mm	0,2 mm	0,3 mm	0,3 mm
15 cm – 6"	15 cm – 6"	15 cm – 6"	15 cm – 6"
07.64.63	07.64.73	07.64.64	07.64.74



Instrumente mit blau eloxierten Leichtmetall-Griffen für höchste Präzision und Arbeitskomfort.

Instruments with blue anodized light metal handles for maximum precision and working convenience.

Instrumentos con mangos de metal ligero anodizados en azul para la precisión y el confort de trabajo máximo.

Instruments avec manches en métal léger anodisés en bleu pour un maximum de précision et de confort à l'utilisation.

Strumenti con manici di metallo leggero anodizzati blu per una precisione massima e conforto lavorativo.



micro 2000

0,3 mm	0,3 mm	0,4 mm	0,4 mm
18 cm – 7 1/8"	18 cm – 7 1/8"	18 cm – 7 1/8"	18 cm – 7 1/8"
07.64.83	07.64.93	07.64.84	07.64.94



spitz
sharp
aguda
pointu
acuta



stumpf
blunt
roma
mousse
smussa



Vergrößerung
Magnification
Engrandecimiento
Agrandissement
Ingrandimento



Titan
Titanium
Titanio
Titane
Titanio

Mikro Pinzetten
Micro Forceps
Micro pinzas
Micro pincers
Micro pinze

A03

Ti

8 mm



0,4 mm

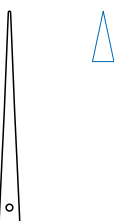

0,4 mm

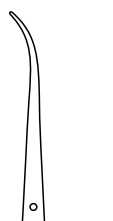

0,8 mm

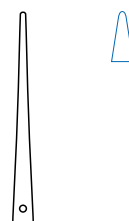

0,8 mm

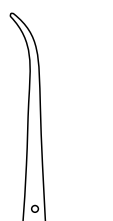

15 cm - 6"

07.74.15

15 cm - 6"

07.75.15

15 cm - 6"

07.76.15

15 cm - 6"

07.77.15

18 cm - 7 1/8"

07.74.18

18 cm - 7 1/8"

07.75.18

18 cm - 7 1/8"

07.76.18

18 cm - 7 1/8"

07.77.18

21 cm - 8 1/4"

07.74.21

21 cm - 8 1/4"

07.75.21

21 cm - 8 1/4"

07.76.21

21 cm - 8 1/4"

07.77.21



Ti

8 mm



Ø 1 mm

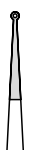

Ø 2 mm



Ø 1 mm

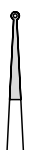

Ø 2 mm



15 cm - 6"

59.45.15

15 cm - 6"

59.46.15

15 cm - 6"

59.47.15

15 cm - 6"

59.48.15

18 cm - 7 1/8"

59.45.18

18 cm - 7 1/8"

59.46.18

18 cm - 7 1/8"

59.47.18

18 cm - 7 1/8"

59.48.18

21 cm - 8 1/4"

59.45.21

21 cm - 8 1/4"

59.46.21

21 cm - 8 1/4"

59.47.21

21 cm - 8 1/4"

59.48.21



A03

Nahtpinzetten Suturing Forceps Pinzas para sutura Pincas à suture Pinze per sutura



micro 2000

	0,3 mm	0,3 mm	0,6 mm	0,6 mm	0,6 mm	0,6 mm
	15 cm - 6"	15 cm - 6"	15 cm - 6"	15 cm - 6"	18 cm - 7 1/8"	18 cm - 7 1/8"
	13.71.42	13.71.43	13.71.58	13.71.59	13.71.82	13.71.83



	0,3 mm	0,3 mm	0,3 mm	0,3 mm
	12 cm - 4 3/4"	12 cm - 4 3/4"	12 cm - 4 3/4"	12 cm - 4 3/4"
	13.71.50	13.71.51	13.71.52	13.71.53
	15 cm - 6"	15 cm - 6"	15 cm - 6"	15 cm - 6"
	13.71.60	13.71.61	13.71.62	13.71.63
	18 cm - 7 1/8"	18 cm - 7 1/8"	18 cm - 7 1/8"	18 cm - 7 1/8"
	13.71.70	13.71.71	13.71.72	13.71.73

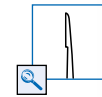

	0,6 mm
	23 cm - 9"
	13.71.84

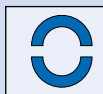

Rundgriff
Round handle
Mango redondo
Manche rond
Manico rotondo



Vergrößerung
Magnification
Engrandecimiento
Agrandissement
Ingrandimento

Gewebefasspinzetten
Tissue Grasping Forceps
Pinzas para agarrar tejidos
Pinces à saisir les tissus
Pinze per afferrare tessuti

A03

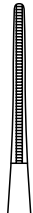

15 cm - 6"
06.50.15

DeBakey "AT"



15 cm - 6"
07.15.15

Russ. Modell



15 cm - 6"
07.19.15

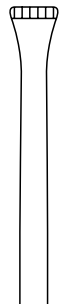

23 cm - 9"
07.19.23

Nelson



"AT"
 Atraumatische Riefung
 Atraumatic serration
 Estrías atraumáticas
 Striure atraumatique
 Zigrinatura atraumatica



A03

Gewebefasspinzetten
Tissue Grasping Forceps
Pinzas para agarrar tejidos
Pinces à saisir les tissus
Pinze per afferrare tessuti



13 cm - 5 1/8"
07.35.13

Troeltsch (Wilde)

Lidfasspinzette
 Lid grasping forceps
 Pinza para agarrar párpados
 Pince à saisir les paupières
 Pinza per afferrare palpebre

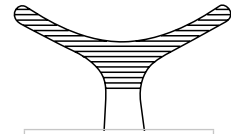

8 cm - 3 1/8"
60.55.40

Walter

Gewebefasszange
 Tissue grasping forceps
 Pinza para agarrar tejidos
 Pince à saisir les tissus
 Pinza per afferrare tessuti



15,5 cm - 6 1/8"
67.58.45

Fox

Gewebe- und Knorpelfasspinzetten
Tissue and Cartilage Grasping Forceps
Pinzas para agarrar tejidos y cartilagos
Pinces pour saisir les tissus et cartilage
Pinze per afferrare tessuti e cartilagine

A03



Fox



15 cm - 6"
67.58.36

mit Sperre
 with catch
 con cierre
 avec crémaillère
 con cremagliera



Fox



13 cm - 5 1/8"
67.58.33



15 cm - 6"
67.58.35

A04

“HM”

Nadelhalter mit Hartmetalleinlagen
 Needle holders with tungsten carbide inserts
 Porta-agujas con bocas revestidas con plaquitas de carburo de tungsteno
 Porte-aiguilles avec mors en carbure de tungstène
 Portaghi con placchette di carburo di tungsteno

N 0,5 mm

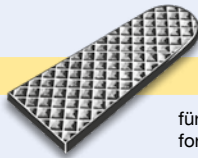

normal
 regular
 normal
 normale
 normale

für Nadeln und Nahtmaterial bis Stärke 4-0
 for needles and sutures up to size 4-0
 para agujas y material de sutura hasta el espesor de 4-0
 pour aiguilles et matériel à suture jusqu'à une épaisseur de 4-0
 per aghi e materiale per sutura fino ad uno spessore di 4-0

F 0,4 mm

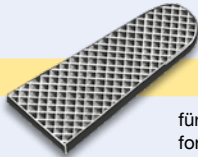

fein
 fine
 fine
 fine
 fine

für feine Nadeln und Nahtmaterial in der Stärke 5-0 und 6-0
 for delicate needles and sutures sizes 5-0 and 6-0
 para agujas finas y material de sutura para espesores 5-0 y 6-0
 pour aiguilles fines et matériel à suture d'une épaisseur de 5-0 et 6-0
 per aghi fini e materiale per sutura fino ad uno spessore di 5-0 e 6-0

EF 0,3 mm

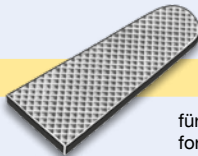

extra-fein
 extra-fine
 extra-fino
 extra-fine
 extra-fine

für Mikro-Nadeln und Nahtmaterial bis Stärke 10-0
 for micro-needles and sutures up to size 10-0
 para micro-agujas y material de sutura hasta el espesor de 10-0
 pour micro-aiguilles et matériel à suture jusqu'à une épaisseur de 10-0
 per aghi micro e materiale per sutura fino ad uno spessore di 10-0

glatt
 smooth
 liso
 lisse
 liscia

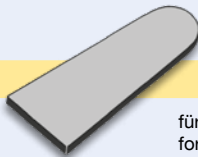

für feine Nadeln und Nahtmaterial in der Stärke 7-0 bis 10-0
 for delicate needles and sutures from sizes 7-0 to 10-0
 para agujas finas y material de sutura para espesores 7-0 y 10-0
 pour aiguilles fines et matériel à suture d'une épaisseur de 7-0 à 10-0
 per aghi fini e materiale per sutura fino ad uno spessore di 7-0 fino a 10-0



13 cm - 5 1/8"
10.04.13

Collier

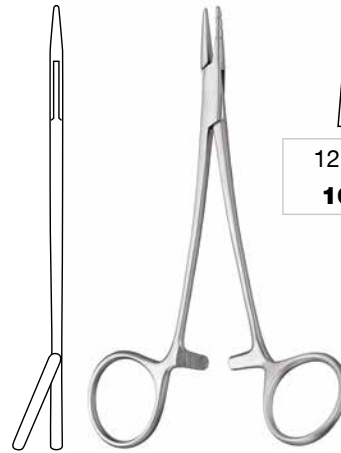

12,5 cm - 5"
10.08.12

Neivert

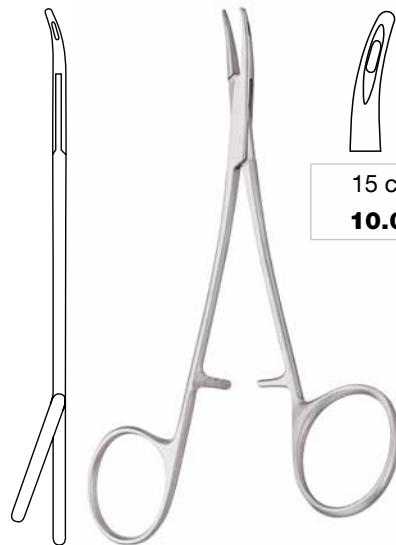

15 cm - 6"
10.08.15

Converse



Nadelhalter
Needle Holders
Porta-agujas
Porte-aiguilles
Portaghi

A04

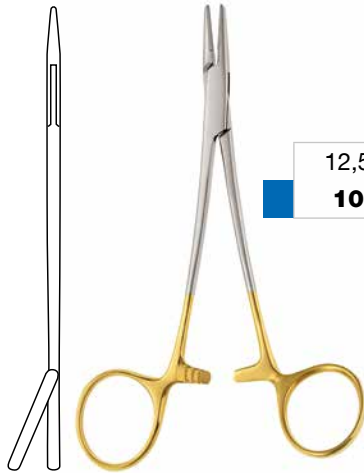

12,5 cm - 5"
10.08.62

Neivert "HM"

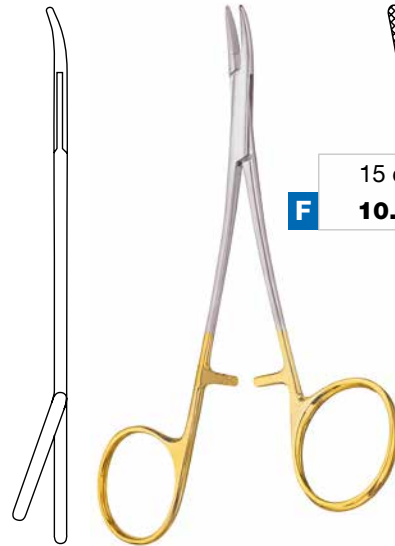

15 cm - 6"
F 10.08.65

Converse "HM"

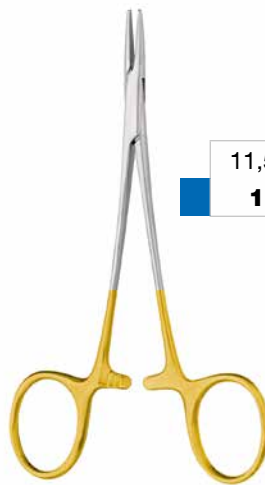

11,5 cm - 4½"
10.09.61

13 cm - 5⅛"
10.09.63

Nagata "HM"

"HM"

Hartmetall
Tungsten carbide
Carburo de tungsteno
Carbure de tungstène
Carburo di tungsteno

F

5-0 and 6-0

fein
fine
fino
fine
fine

■

7-0 to 10-0

glatt
smooth
liso
lisse
liscia



12,5 cm - 5"
10.12.12

Wright (Derf)



13,5 cm - 5 3/8"
10.12.13

Halsey



F 12,5 cm - 5"
10.12.62

Wright (Derf) "HM"



F 13,5 cm - 5 3/8"
10.12.63

Halsey "HM"

"HM"
 Hartmetall
 Tungsten carbide
 Carburo de tungsteno
 Carbure de tungstène
 Carburo di tungsteno

F
 5-0 and 6-0
 fein
 fine
 fino
 fine
 fine



**Nadelhalter
Needle Holders
Porta-agujas
Porte-aiguilles
Portaghi**

A04



12,5 cm - 5"
10.12.82

Derf-Converse



16 cm - 6¼"
10.18.15



18 cm - 7½"
10.18.18



20 cm - 8"
10.18.20



23 cm - 9"
10.18.23



24 cm - 9½"
10.18.24

Mayo-Hegar



Mayo-Hegar "HM"

N				
	16 cm – 6¼" 10.18.65	18 cm – 7⅛" 10.18.68	20 cm – 8" 10.18.70	23 cm – 9" 10.18.73

N			
	24 cm – 9½" 10.18.74	26 cm – 10¼" 10.18.76	30 cm – 11¾" 10.18.80

Ti



Mayo-Hegar "HM"

N				
	16 cm – 6¼" 10.18.85	18 cm – 7⅛" 10.18.88	20 cm – 8" 10.18.90	23 cm – 9" 10.18.93

N
4-0
normal
regular
normal
normale
normale

"HM"
Hartmetall
Tungsten carbide
Carburo de tungsteno
Carbure de tungstène
Carburo di tungsteno

Ti
Titan
Titanium
Titanio
Titane
Titanio



Nadelhalter
Needle Holders
Porta-agujas
Porte-aiguilles
Portaghi

A04



Crile-Wood

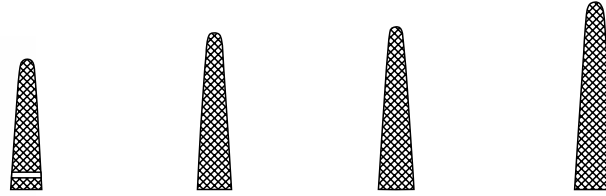

15 cm - 6"	18 cm - 7 ¹ / ₈ "	20 cm - 8"	23 cm - 9"
10.20.15	10.20.18	10.20.20	10.20.23



Crile-Wood "HM"
(DeBakey "HM")

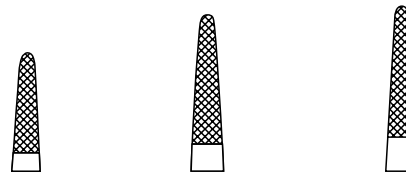

F 15 cm - 6"	18 cm - 7 ¹ / ₈ "	20 cm - 8"
10.20.65	10.20.68	10.20.70

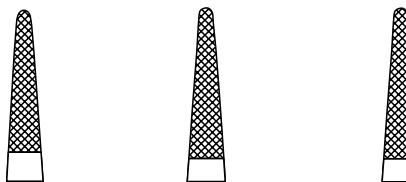

F 23 cm - 9"	25 cm - 10"	30 cm - 11 ³ / ₄ "
10.20.73	10.20.75	10.20.80

"HM"
Hartmetall
Tungsten carbide
Carburo de tungsteno
Carbure de tungstène
Carburo di tungsteno

F
5-0 and 6-0
fein
fine
fino
fine
fine

Nadelhalter
Needle Holders
Porta-agujas
Porte-aiguilles
Portaghi

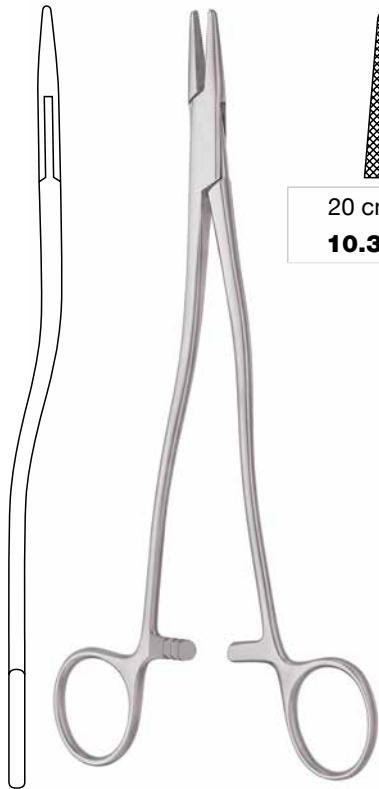

A04



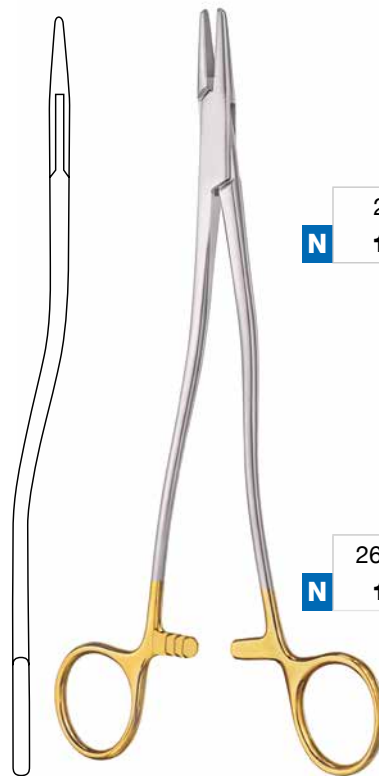

 20 cm - 8"
10.37.20

Thomson-Walker (Bozemann)



 
 20 cm - 8" 24 cm - 9½"
N **10.37.70** **10.37.74**

Bozemann (Wertheim) "HM"



 
 26 cm - 10¼" 30 cm - 11¾"
N **10.37.76** **10.37.80**



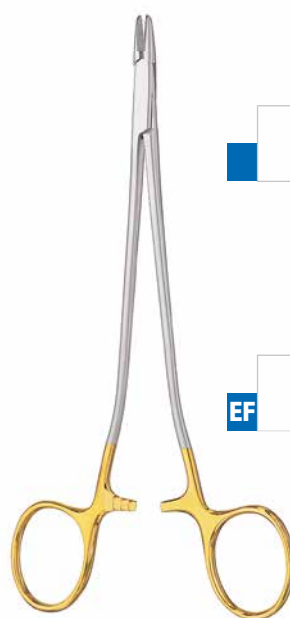

 17 cm - 6¾"
10.39.17

Senning



 
 15 cm - 6" 17 cm - 6¾"
10.39.64 **10.39.66**

Senning "HM"

 
 15 cm - 6" 17 cm - 6¾"
EF **10.39.65** **10.39.67**

N
 4-0
 normal
 regular
 normal
 normale
 normale



 7-0 to 10-0
 glatt
 smooth
 liso
 lisse
 liscia

EF
 10-0
 extra-fein
 extra-fine
 extra-fino
 extra-fine
 extra-fine

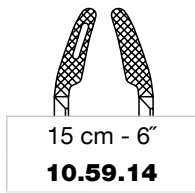

**Nadelhalter
Needle Holders
Porta-agujas
Porte-aiguilles
Portaghi**

A04



15 cm - 6"
10.59.14

Gillies-slim

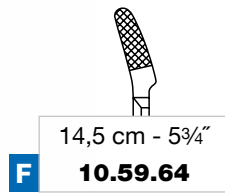

14,5 cm - 5 3/4"
F 10.59.64

Gillies-slim "HM"

Nadelhalter mit Schere
Needle holders with scissors
Porta-agujas con tijeras
Porte-aiguilles avec ciseaux
Portaghi con forbice

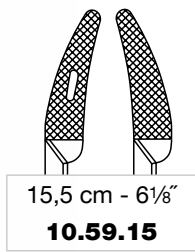
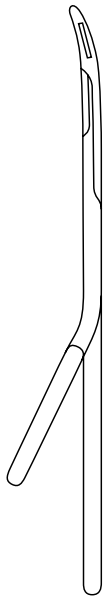

15,5 cm - 6 1/8"
10.59.15

Gillies

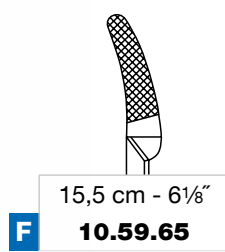

15,5 cm - 6 1/8"
F 10.59.65

Gillies "HM"

"HM"
Hartmetall
Tungsten carbide
Carburo de tungsteno
Carbure de tungstène
Carburo di tungsteno

F
5-0 and 6-0
fein
fine
fino
fine
fine



Mathieu "HM"

N				
	14 cm - 5½"	17 cm - 6¾"	20 cm - 8"	24 cm - 9½"
	11.20.64	11.20.67	11.20.70	11.20.74

Schleimhaut-Nadelhalter
 Mucosa needle holders
 Porta-agujas para mucosa
 Porte-aiguilles pour suture de la muqueuse
 Portaghi per mucosa



Cottle-Masing

a = 60 mm	a = 90 mm
67.92.06	67.92.09



glattes Maulteil
 smooth jaws
 boca lisa
 mors lisses
 morsi lisci



Mikro Nadelhalter
Micro Needle Holders
Micro porta-agujas
Micro porte-aiguilles
Micro portaghi

A04



Castroviejo-micro



14,5 cm – 5¾"
11.70.24



14,5 cm – 5¾"
11.70.25



14,5 cm – 5¾"
11.70.22



14,5 cm – 5¾"
11.70.23



Castroviejo (Koshima)



14,5 cm – 5¾"
11.70.26



14,5 cm – 5¾"
11.70.27



14,5 cm – 5¾"
11.70.28



14,5 cm – 5¾"
11.70.29



14 cm – 5½"
11.62.64



17 cm – 6¾"
11.62.67



14 cm – 5½"
11.62.84



17 cm – 6¾"
11.62.87

EF



Castroviejo "HM"



11,5 cm – 4½"
11.74.13



14 cm – 5½"
11.74.23



11,5 cm – 4½"
11.74.15



14 cm – 5½"
11.74.25



Barraquer

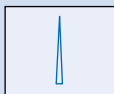

Ultra fein
Ultra fine
Ultra fina
Ultra delicate
Molto delicata

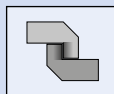

mit Sperre
with catch
con cremallera
avec crémaillère
con cremagliera



EF
10-0
extra-fein
extra-fine
extra-fino
extra-fine
extra-fine

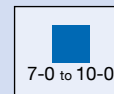

glatt
smooth
liso
lisse
liscia

Mikro Nadelhalter
Micro Needle Holders
Micro porta-agujas
Micro porte-aiguilles
Micro portaghi

A04

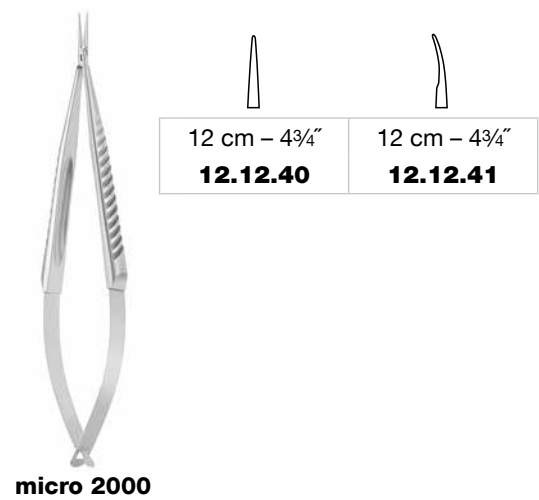
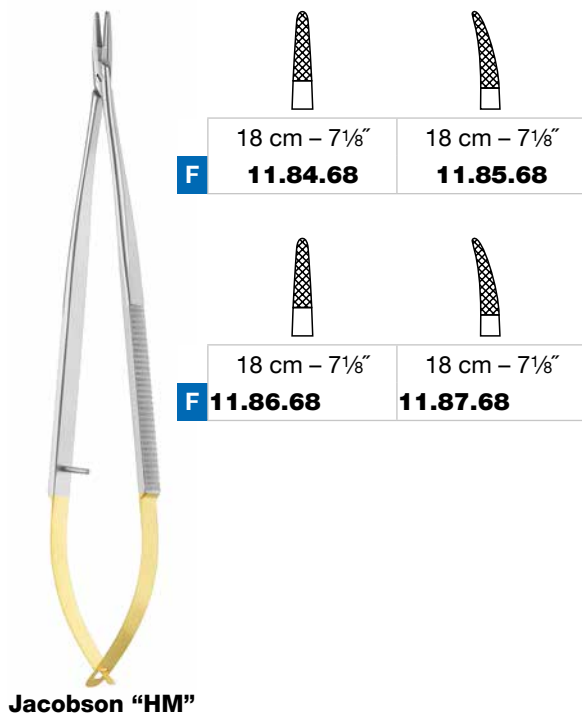
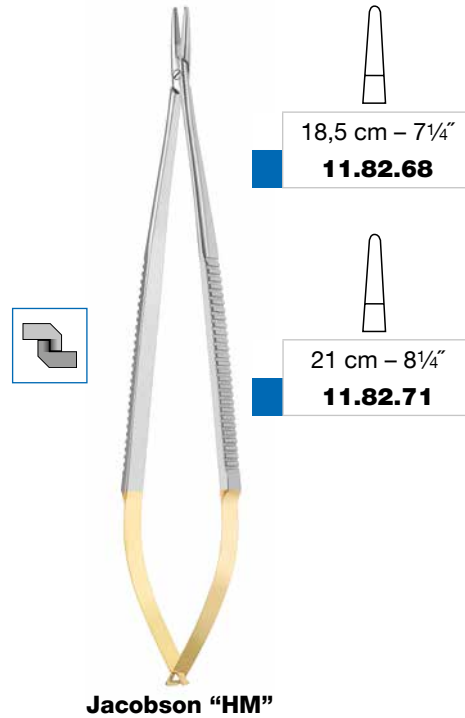
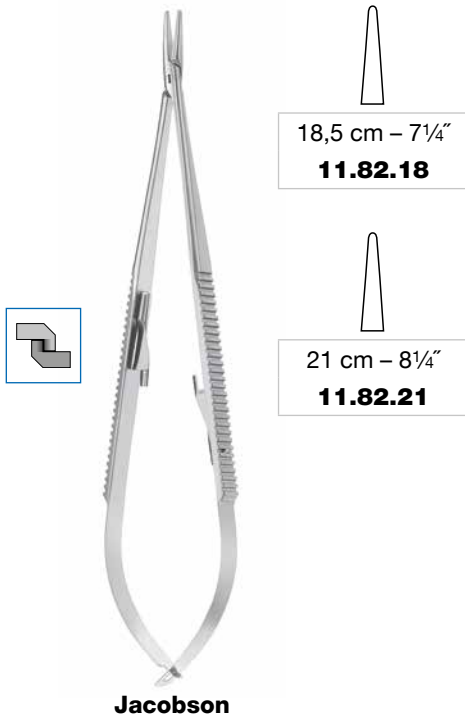

 7-0 to 10-0
 glatt
 smooth
 liso
 lisse
 liscia

F
 5-0 to 6-0
 fein
 fine
 fino
 fine
 fine

"HM"
 Hartmetall
 Tungsten carbide
 Carburo de tungsteno
 Carbone de tungstène
 Carburo di tungsteno

 mit Sperre
 with catch
 con cremallera
 avec crémaillère
 con cremagliera



Mikro Nadelhalter
Micro Needle Holders
Micro porta-agujas
Micro porte-aiguilles
Micro portaghi

A04



micro 2000



15 cm – 6"
12.15.70



15 cm – 6"
12.15.71



18 cm – 7 1/8"
12.18.70



18 cm – 7 1/8"
12.18.71



micro 2000



15 cm – 6"
12.15.72



15 cm – 6"
12.15.73



18 cm – 7 1/8"
12.18.72



18 cm – 7 1/8"
12.18.73



18 cm – 7 1/8"
12.18.74



18 cm – 7 1/8"
12.18.75



Instrumente mit blau eloxierten Leichtmetall-Griffen für höchste Präzision und Arbeitskomfort.

Instruments with blue anodized light metal handles for maximum precision and working convenience.

Instrumentos con mangos de metal ligero anodizados en azul para la precisión y el confort de trabajo máximo.

Instruments avec manches en métal léger anodisés en bleu pour un maximum de précision et de confort à l'utilisation.

Strumenti con manici di metallo leggero anodizzati blu per una precisione massima e conforto lavorativo.

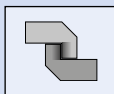

mit Sperre
 with catch
 con cremallera
 avec crémaillère
 con cremagliera



Beschichtung mit Diamantstaub
 Coating with diamond dust
 Recubierto con polvo de diamante
 Revêtement avec de poussière de diamant
 Rivestito con polvere di diamante

Mikro Nadelhalter
Micro Needle Holders
Micro porta-agujas
Micro porte-aiguilles
Micro portaghi

A04

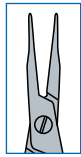

0,4 mm



0,4 mm



0,5 mm



0,5 mm



13 cm – 5 1/8"	12.12.54	12.12.55		12.12.59
15 cm – 6"	12.15.76	12.15.77		
18 cm – 7 1/8"	12.18.76	12.18.77	12.18.80	12.18.81
21 cm – 8 1/4"	12.21.76	12.21.77	12.21.80	12.21.81

15 cm – 6"	12.15.56	12.15.57			
18 cm – 7 1/8"	12.18.56	12.18.57	12.18.60	12.18.61	
21 cm – 8 1/4"	12.21.56	12.21.57	12.21.60	12.21.61	

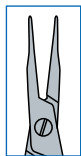

0,4 mm



0,4 mm



0,5 mm



0,5 mm



13 cm – 5 1/8"	12.12.56	12.12.57		12.12.61
15 cm – 6"	12.15.78	12.15.79		
18 cm – 7 1/8"	12.18.78	12.18.79	12.18.82	12.18.83
21 cm – 8 1/4"	12.21.78	12.21.79	12.21.82	12.21.83

15 cm – 6"	12.15.66	12.15.67			
18 cm – 7 1/8"	12.18.66	12.18.67	12.18.68	12.18.69	
21 cm – 8 1/4"	12.21.66	12.21.67	12.21.70	12.21.71	

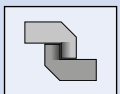

mit Sperre
with catch
con cremallera
avec crémaillère
con cremagliera



Beschichtung mit Diamantstaub
Coating with diamond dust
Recubierto con polvo de diamante
Revêtement avec de poussière de diamant
Rivestito con polvere di diamante

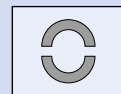

Rundgriff
Round handle
Mango redondo
Manche rond
Manico rotondo



Mikro Nadelhalter
Micro Needle Holders
Micro porta-agujas
Micro porte-aiguilles
Micro portaghi

A04



15 cm – 6"
12.16.75

18 cm – 7 1/8"
12.18.85

21 cm – 8 1/4"
12.21.95



15 cm – 6"
12.16.77

18 cm – 7 1/8"
12.18.87

21 cm – 8 1/4"
12.21.97



15 cm – 6"
12.16.76

18 cm – 7 1/8"
12.18.86

21 cm – 8 1/4"
12.21.96



15 cm – 6"
12.16.78

18 cm – 7 1/8"
12.18.88

21 cm – 8 1/4"
12.21.98

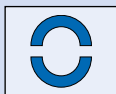

Rundgriff
Round handle
Mango redondo
Manche rond
Manico rotondo

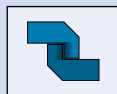

mit Sperre
with catch
con cremallera
avec crémaillère
con cremagliera





Titan
Titanium
Titanio
Titane
Titanio

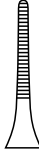

1:1

Diethrich

		
4,5 cm – 1¾"	5 cm – 2"	5,5 cm – 2⅛"
F = 100 g	F = 100 g	F = 100 g
15.10.08	15.10.12	15.10.16





1:1

Diethrich

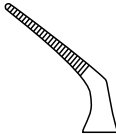
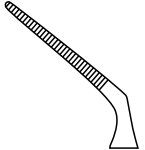
		
4,5 cm – 1¾"	5 cm – 2"	5,5 cm – 2⅛"
F = 100 g	F = 100 g	F = 100 g
15.11.08	15.11.12	15.11.16





Arterienklemmen
Hemostatic Forceps
Pinzas hemostáticas
Pinces hémostatiques
Pinze emostatiche

A05



Micro-Halsted



12,5 cm - 5"
15.40.12



12,5 cm - 5"
15.41.12



12,5 cm - 5"
15.42.12

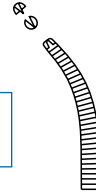

12,5 cm - 5"
15.43.12

- superfeine Modelle
- höchste Präzision
- geringes Gewicht
- ultra delicate models
- highest precision
- light weight
- modelos super finos
- máxima precisión
- peso ligero
- modèles superfins
- précision maximum
- poids léger
- modelli molto delicati
- alta precisione
- peso minimo



Micro-Jacobson

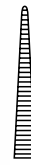

12,5 cm - 5"
15.40.82



12,5 cm - 5"
15.41.82



Mosquito "AT"



12,5 cm - 5"
15.44.42



12,5 cm - 5"
15.45.42

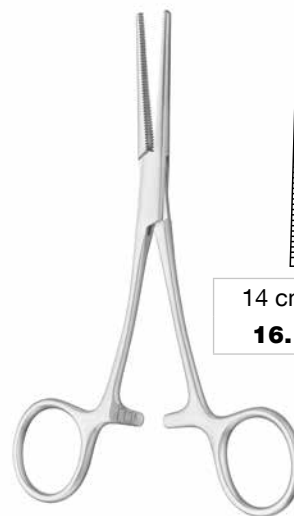

Pea



14 cm - 5½"
16.10.14



Vergrößerung
Magnification
Engrandecimiento
Agrandissement
Ingrandimento

"AT"

Atraumatische Riefung
Atraumatic serration
Estrías atraumáticas
Striure atraumatique
Striatura atraumatica



**Micro-Jacobson
(Koshima)**



12,5 cm - 5"
15.40.84



12,5 cm - 5"
15.41.84

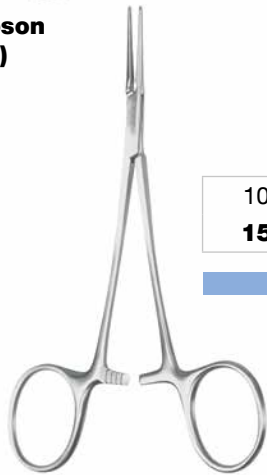

10 cm - 4"
15.44.10



10 cm - 4"
15.45.10



12,5 cm - 5"
15.44.22



12,5 cm - 5"
15.45.22

ULTRA



Providence-Hospital



14 cm - 5½"
15.50.14

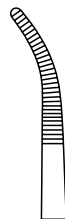

14 cm - 5½"
15.51.14



14 cm - 5½"
15.52.14



14 cm - 5½"
15.53.14



Vergrößerung
 Magnification
 Engrandecimiento
 Agrandissement
 Ingrandimento



Arterienklemmen
Hemostatic Forceps
Pinzas hemostáticas
Pinces hémostatiques
Pinze emostatiche

A05



Halsted-Mosquito



12,5 cm - 5"
15.44.12



12,5 cm - 5"
15.45.12



12,5 cm - 5"
15.46.12

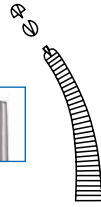

12,5 cm - 5"
15.47.12

Ti



Halsted-Mosquito



12,5 cm - 5"
15.44.32



12,5 cm - 5"
15.45.32



12,5 cm - 5"
15.46.32

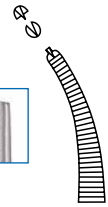

12,5 cm - 5"
15.47.32



Leriche



15 cm - 6"
15.56.15



15 cm - 6"
15.57.15



15 cm - 6"
15.58.15

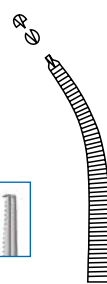

15 cm - 6"
15.59.15

Ti

Titan
Titanium
Titanio
Titane
Titano







Vergrößerung
Magnification
Engrandecimiento
Agrandissement
Ingrandimento





Mikro-Gefäßclips und Anlegepinzetten
Micro Vessel Clips and Applying Forceps
Micro clips vasculares y pinzas para aplicar
Micro clips vasculaires et pinces à appliquer
Micro clip vascolari e pinze per applicare

A06

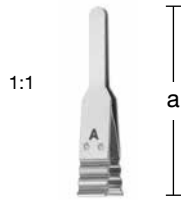
Clips (einzeln)
 Clips (single)
 Clips (singular)
 Clips (seuls)
 Clip (singola)

			
	a = 11 mm Ø 0,6 - 1,5 mm	a = 14 mm Ø 1,0 - 2,25 mm	
P 	56.85.10	A 56.85.13	A
P 	56.85.11	V 56.85.14	V



			
	a = 17 mm Ø 1,0 - 2,25 mm	a = 25 mm Ø 1,5 - 3,5 mm	
P 	56.85.16	A 56.85.18	A
P 	56.85.17	V 56.85.19	V

Anlegepinzetten
 Applying forceps
 Pinzas para aplicar
 Pincès à appliquer
 Pinze per applicare

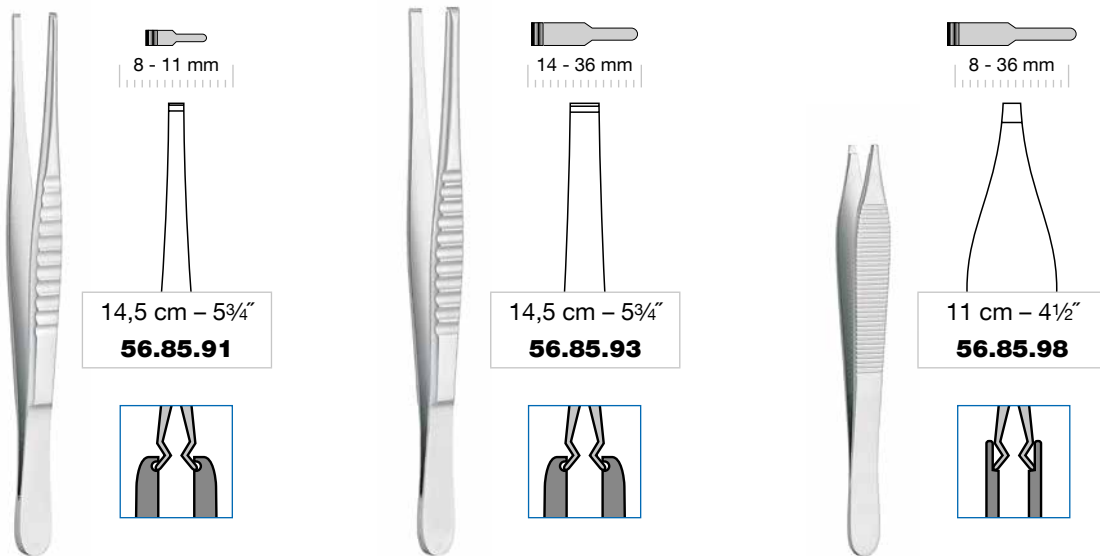

 Gefäßdurchmesser
 Vessel diameter
 Diámetro del vaso
 Diamètre du vaisseau
 Diametro del vaso

A für Arterien
 for arteries
 para arterias
 pour artères
 per arterie

V für Venen
 for veins
 para venas
 pour veines
 per vene

P  Verpackungseinheit "X" Stück
 Packing unit "X" pieces
 Paquete de "X" unidades
 Emballage de "X" pièces
 Confezione da "X" pezzi



Mikro-Gefäßclips und Anlegepinzetten
Micro Vessel Clips and Applying Forceps
Micro clips vasculares y pinzas para aplicar
Micro clips vasculaires et pinces à appliquer
Micro clip vascolari e pinze per applicare

A06

Clips (einzeln)
 Clips (single)
 Clips (singular)
 Clips (seuls)
 Clip (singola)



Biemer

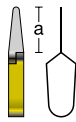

a = 6,0 mm
 F = 30-40 g

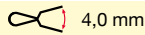

56.87.05



a = 9,0 mm
 F = 30-40 g

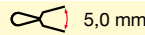

56.87.08

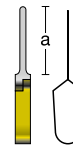

a = 9,0 mm
 F = 20-25 g

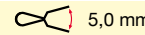

56.87.18

Approximator (1 Clip beweglich)
 Approximator (1 clip mobile)
 Aproximador (1 clip móvil)
 Approximateur (1 clip mobile)
 Approssimatore (1 clip mobile)

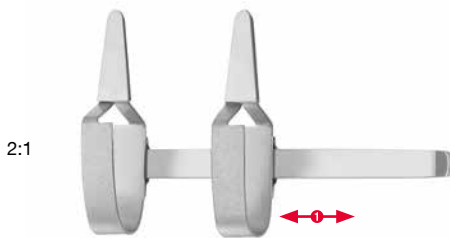

Biemer

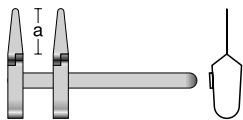

a = 6,0 mm
 F = 30-40 g



56.87.35

Anlegepinzetten
 Applying forceps
 Pinzas para aplicar
 Pincés à appliquer
 Pinze per applicare



Biemer

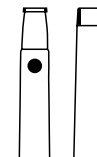

14,5 cm – 5¾"
56.87.45

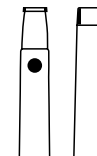

14,5 cm – 5¾"
56.87.46

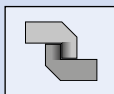

mit Sperre
 with catch
 con cremallera
 avec crémaillère
 con cremagliera

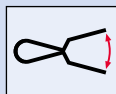

Öffnungsweite
 Opening width
 Apertura de ancho
 Largeur d'ouverture
 Larghezza dell'apertura

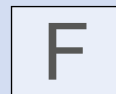

Schließkraft
 Closing pressure
 Fuerza de cierre
 Force de fermeture
 Forza di chiusura

Mikro-Gefäßclips und Anlegepinzetten
Micro Vessel Clips and Applying Forceps
Micro clips vasculares y pinzas para aplicar
Micro clips vasculaires et pinces à appliquer
Micro clip vascolari e pinze per applicare

A06

Approximatoren (2 Clips beweglich)
 Approximators (2 clips mobile)
 Aproximadores (2 clips móviles)
 Approximateurs (2 clip mobiles)
 Approssimatori (2 clip mobili)

a = 8 mm Ø 0,4 - 1,0 mm	a = 11 mm Ø 0,6 - 1,5 mm	a = 14 mm Ø 1,0 - 2,25 mm
A 56.85.47	A 56.85.50	A 56.85.53
V 56.85.48	V 56.85.51	V 56.85.54

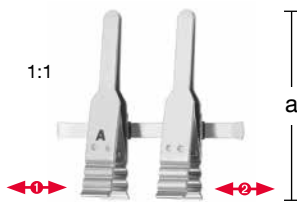

a = 17 mm Ø 1,0 - 2,25 mm	a = 25 mm Ø 1,5 - 3,5 mm
A 56.85.56	A 56.85.58
V 56.85.57	V 56.85.59

Anlegepinzetten
 Applying forceps
 Pinzas para aplicar
 Pincès à appliquer
 Pinze per applicare

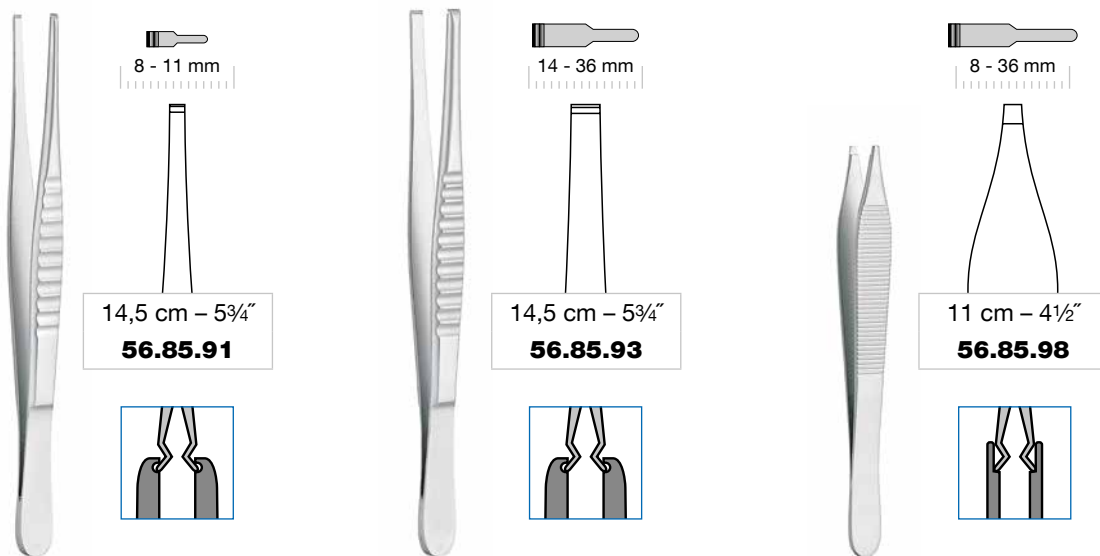

Gefäßdurchmesser
 Vessel diameter
 Diámetro del vaso
 Diamètre du vaisseau
 Diametro del vaso

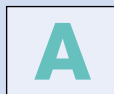

für Arterien
 for arteries
 para arterias
 pour artères
 per arterie



für Venen
 for veins
 para venas
 pour veines
 per vene



A06

Nerv-Approximator
Approximator for nerves
Aproximador para nervios
Approximateur pour nerfs
Approssimatore per nervi

Nerv-Approximator (1 Clip beweglich)
 Approximator for nerves (1 clip mobile)
 Aproximador para nervios (1 clip móvil)
 Approximateur pour nerfs (1 clip mobile)
 Approssimatore per nervi (1 clip mobile)

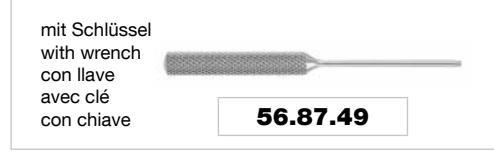
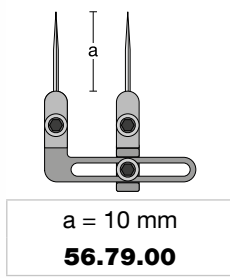
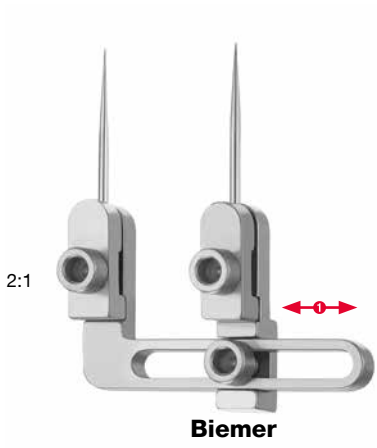

Ersatznadeln
 Spare needles
 Agujas de repuesto
 Aiguilles de rechange
 Aghi di ricambio

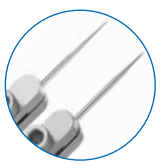

Feine Wundhaken, doppelendig
Delicate Retractors, double-ended
Separadores finos, dobles
Ecarteurs fins, doubles
Divaricatori delicati, doppi

A07



Senn-Miller

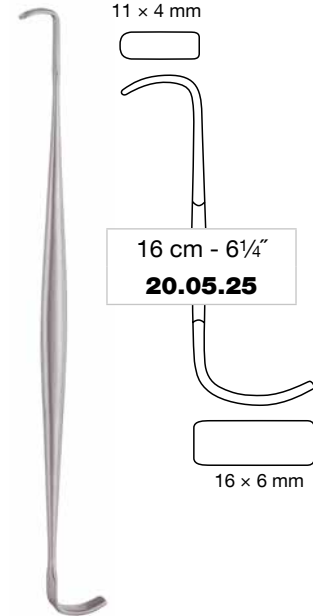
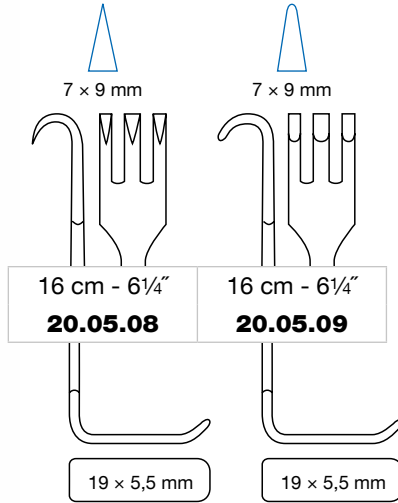

Ragnell

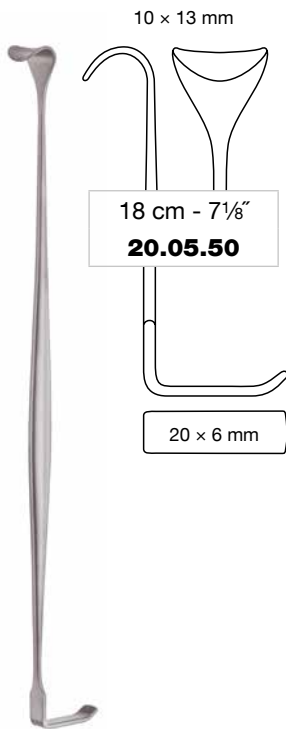
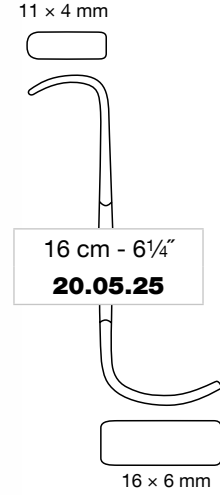

Cope

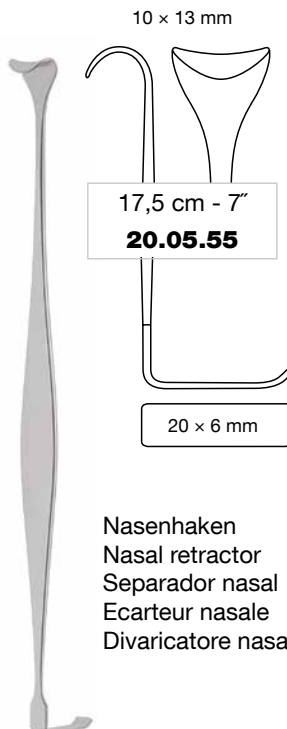
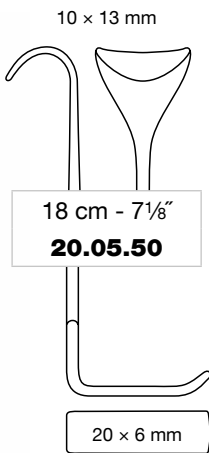

Cope-Walter

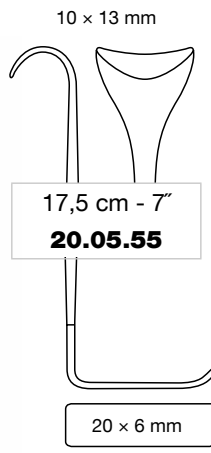

Nasenhaken
 Nasal retractor
 Separador nasal
 Ecarteur nasale
 Divaricatore nasale

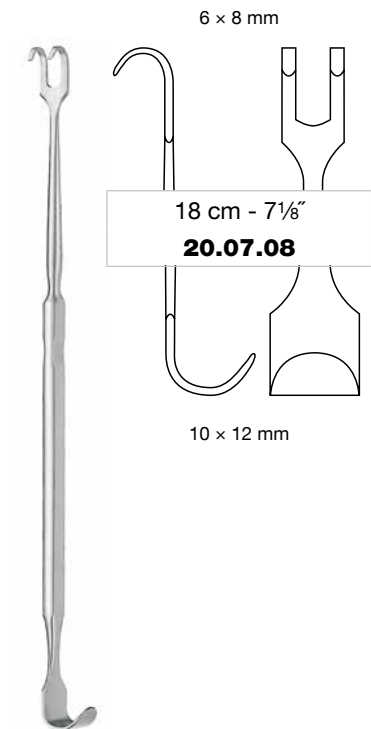

Jackson

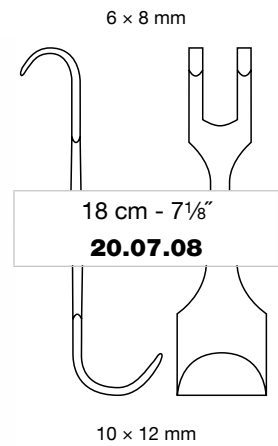

spitz
 sharp
 cortante
 tranchant
 tagliente

stumpf
 blunt
 roma
 mousse
 smussa



Feine Wundhaken
Delicate Retractors
Separadores finos
Ecarteurs fins
Divaricatori delicati

A07



Meyerding

<p>18 x 7 mm</p> <p>18 cm - 7 1/8"</p> <p>20.10.01</p>	<p>16 x 5 mm</p> <p>18 cm - 7 1/8"</p> <p>20.10.02</p>	<p>7 x 4 mm</p> <p>18 cm - 7 1/8"</p> <p>20.10.03</p>
<p>10 x 3 mm</p> <p>18 cm - 7 1/8"</p> <p>20.10.04</p>	<p>7 x 4 mm</p> <p>18 cm - 7 1/8"</p> <p>20.10.05</p>	<p>6 x 10 mm</p> <p>18 cm - 7 1/8"</p> <p>20.10.06</p>



Senn-Green

<p>10 mm</p> <p>14 cm - 5 1/2"</p> <p>20.12.10</p>	<p>20 mm</p> <p>14 cm - 5 1/2"</p> <p>20.12.20</p>
---	---

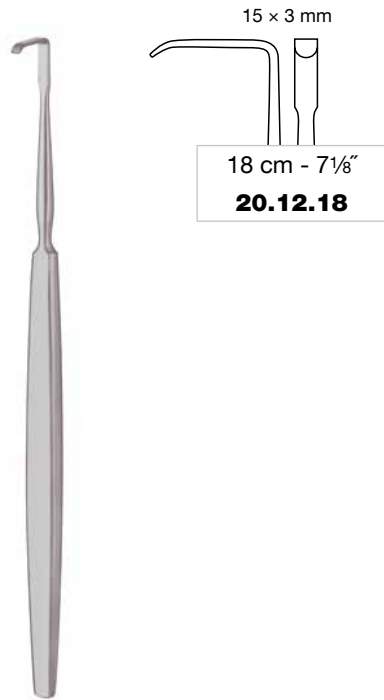

Mod. Lanz

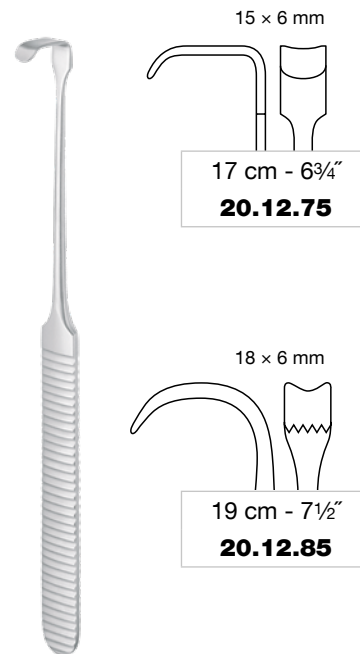

Strandell-Stille

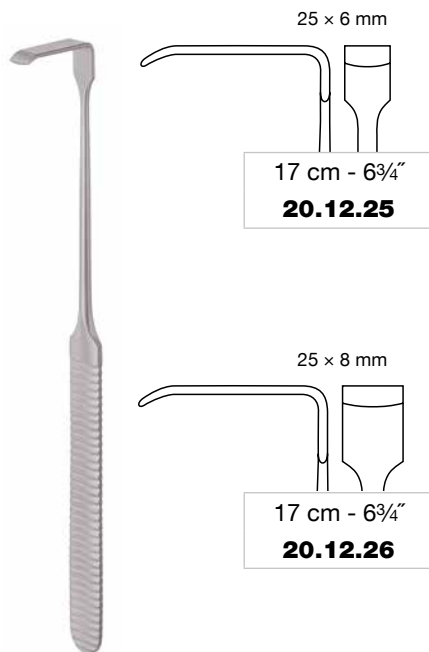

Langenbeck-Green

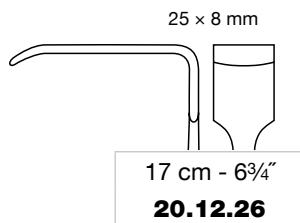



Dura- und Hauthäkchen
Dura and skin hooks
Ganchitos para duramadre y piel
Crochets à dure-mère et peau
Uncini per dura-madre e pelle

A07

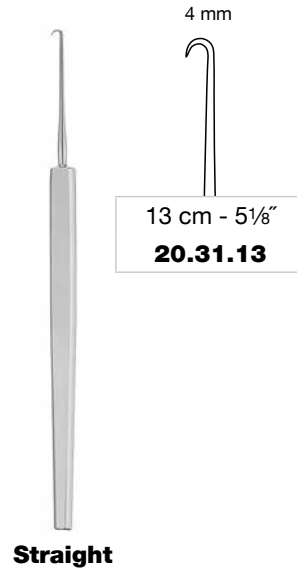
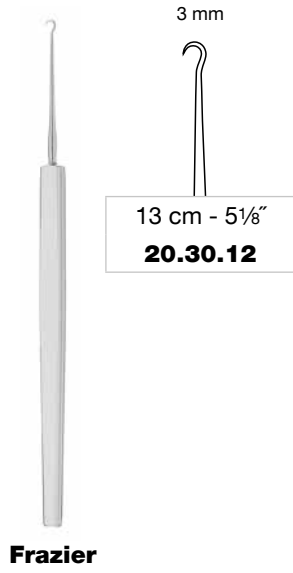

Feine Wundhaken
 Delicate Retractors
 Separadores finos
 Ecarteurs fins
 Divaricatori delicati

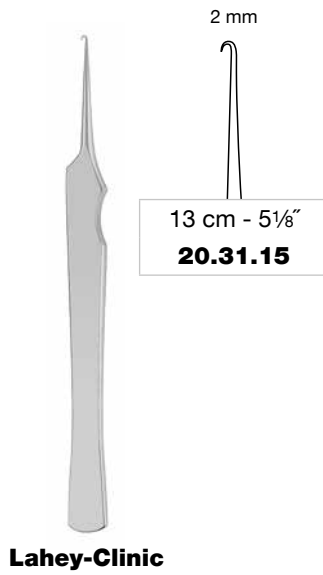

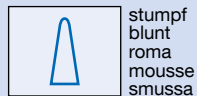
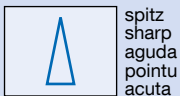
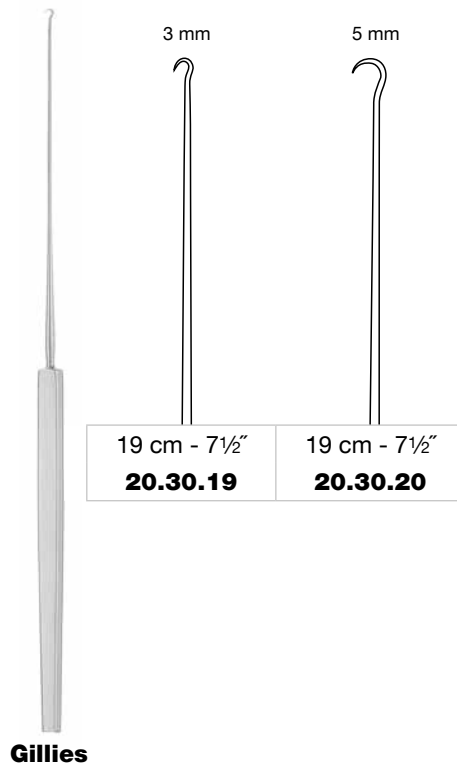
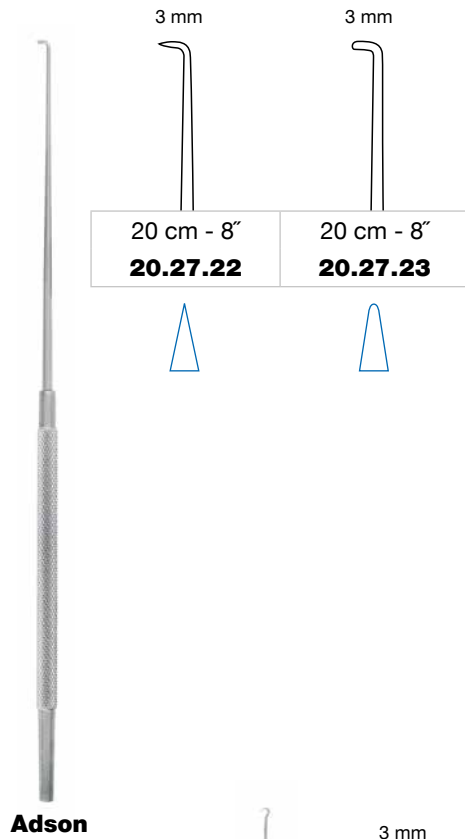



Feine Wundhaken
Delicate Retractors
Separadores finos
Ecarteurs fins
Divaricatori delicati

A07



Barsky

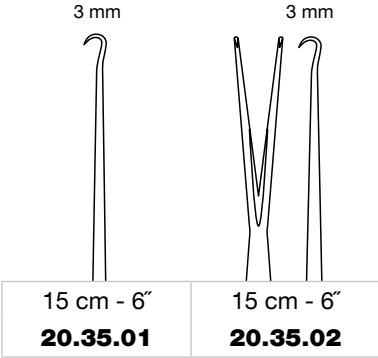

15 cm - 6"
20.35.01

15 cm - 6"
20.35.02

Hauthäkchen
Skin hooks
Ganchitos para piel
Crochets à peau
Uncini per pelle



Kleinert-Kutz

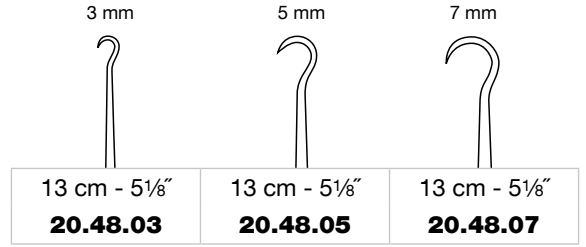

13 cm - 5 1/8"
20.48.03

13 cm - 5 1/8"
20.48.05

13 cm - 5 1/8"
20.48.07

Hauthäkchen
Skin hooks
Ganchitos para piel
Crochets à peau
Uncini per pelle



Bergmann

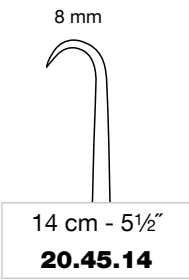

14 cm - 5 1/2"
20.45.14

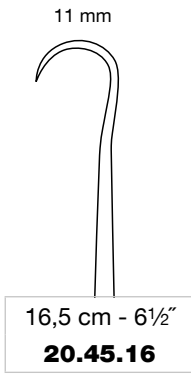

16,5 cm - 6 1/2"
20.45.16



Emmet

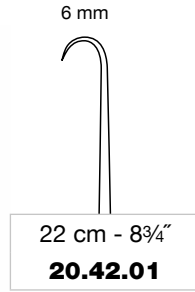

22 cm - 8 3/4"
20.42.01

Fistelhaken
Fistula hook
Ganchito fistular
Crochet à fistules
Uncino fistolare

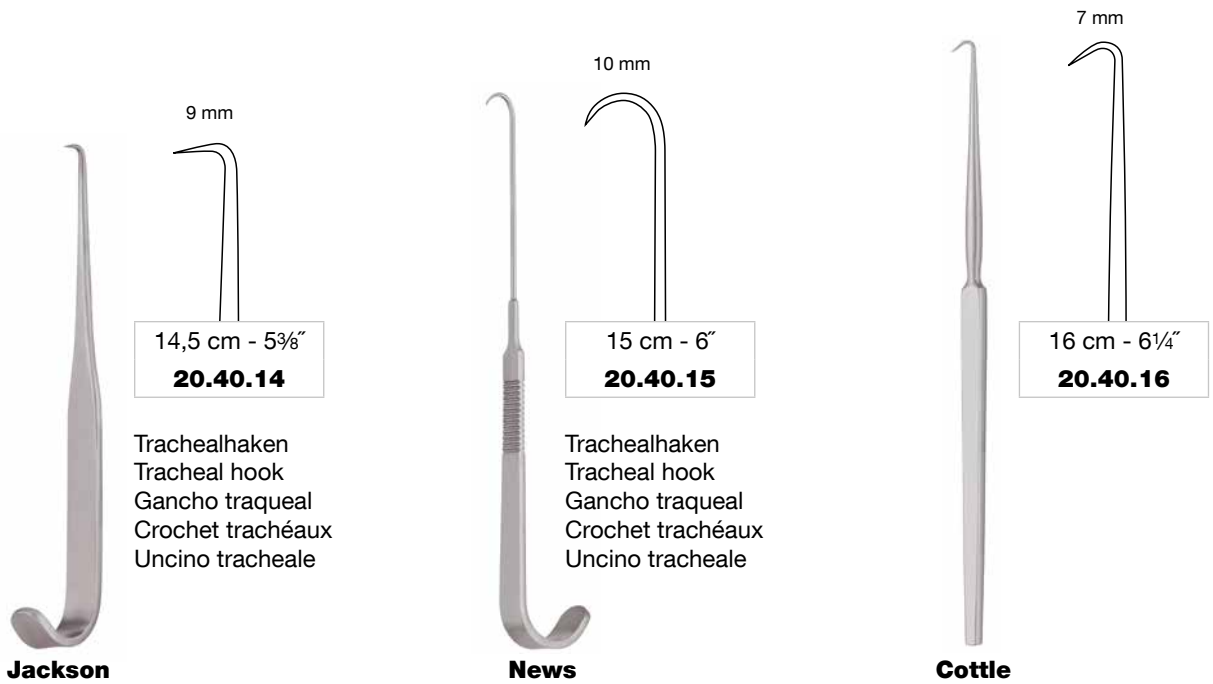

Das zweifach gebogene Arbeitsende ("S"-Form) ermöglicht eine freie Sicht auf das OP-Feld und erleichtert das Assistieren.

The double curved ("S"-form) working end enables a good sight on the operating field and supports the user.

El extremo de trabajo doble curvado (en forma "S") posibilita una buena visión sobre el campo operatorio y facilita la asistencia.

L'extrémité deux fois coudée (en forme de "S") permet une bonne vue sur le champs opératoire et simplifie aussi l'assistance.

L'estremità doppia curvata (forma di "S") rende possibile una migliore vista sul campo operatorio e facilita anche l'assistenza.

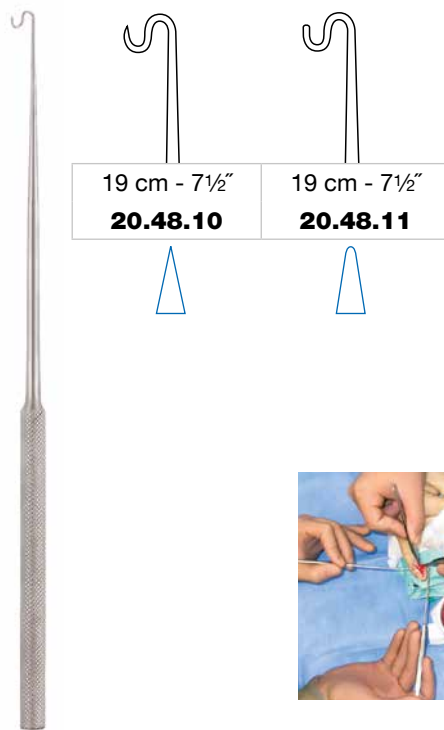

Benicke



spitz
 sharp
 aguda
 pointu
 acuta



stumpf
 blunt
 roma
 mousse
 smussa



Feine Wundhaken
Delicate Retractors
Separadores finos
Ecarteurs fins
Divaricatori delicati

A07

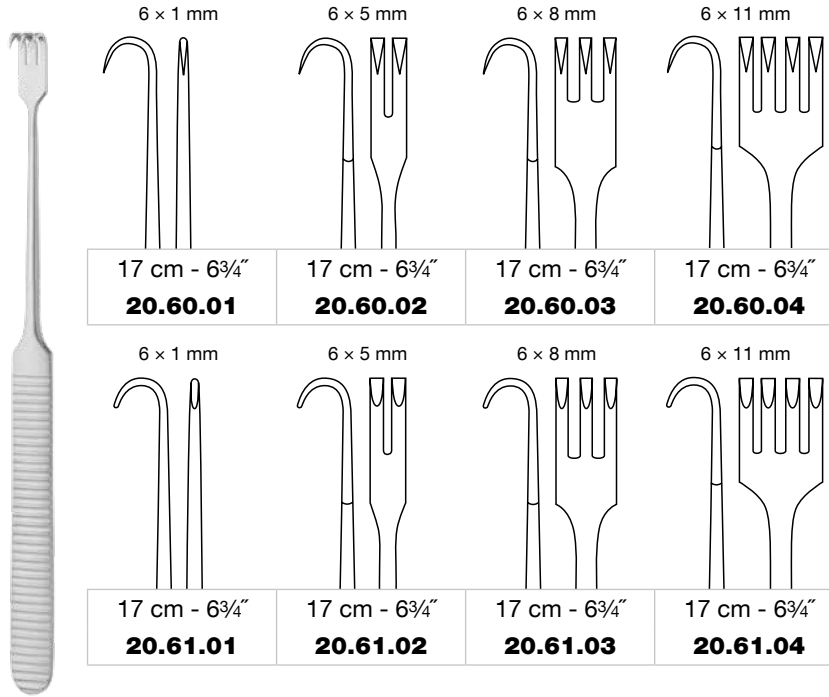

mit flexiblem Federschaft
with flexible shaft
con vástago flexible
avec tige flexible
con asta flessibile

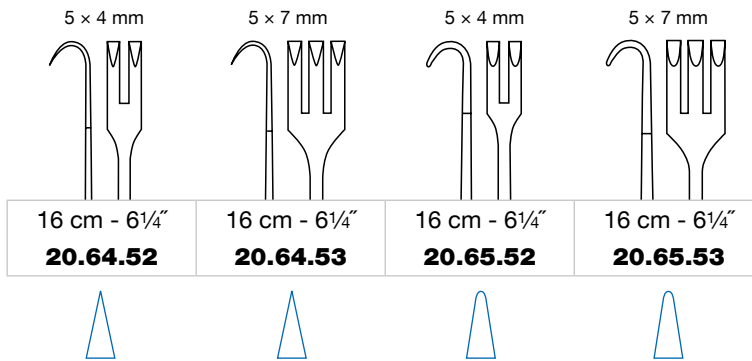

spitz
sharp
cortante
tranchant
tagliante



stumpf
blunt
roma
mousse
smussa

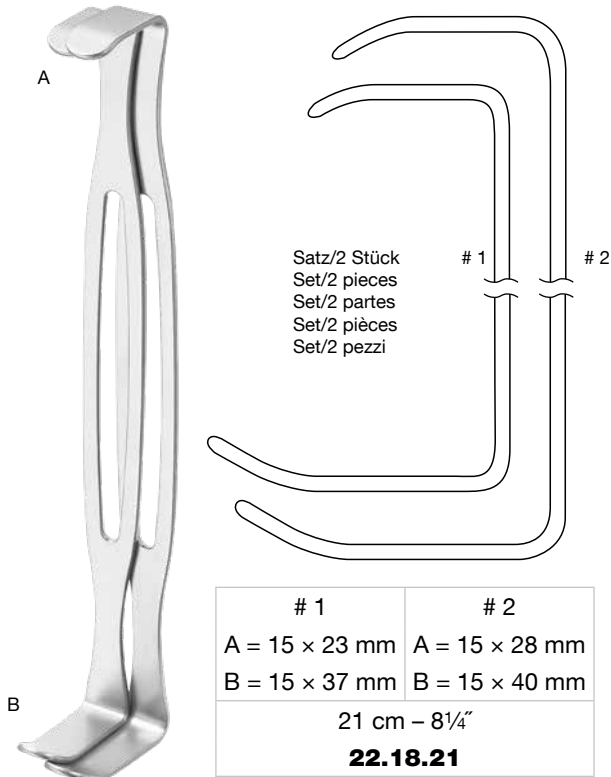

**Parker-Langenbeck
(US Army)**

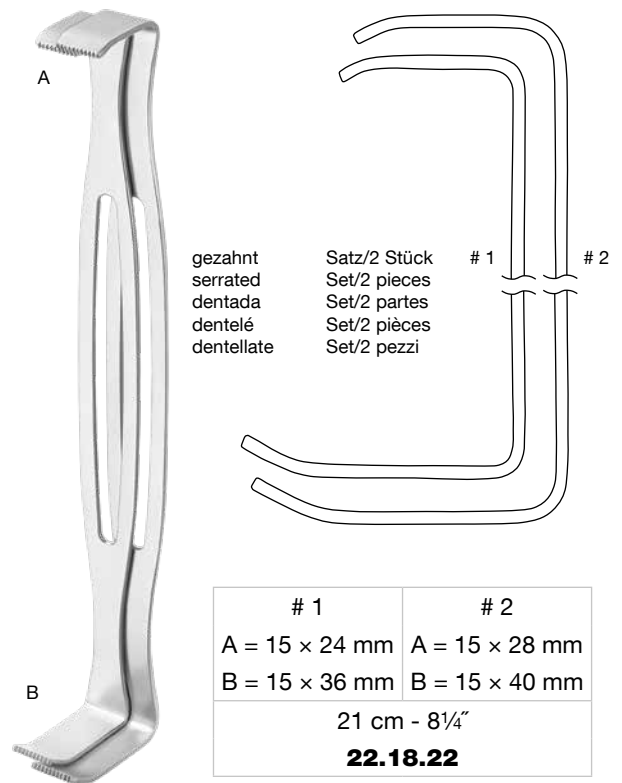

**Parker-Langenbeck
(US Army)**

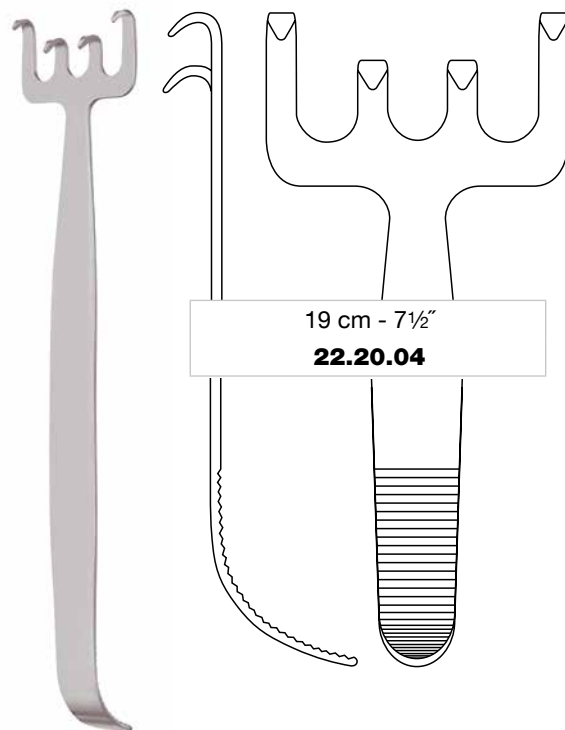

Walter



Mammoplasty
Facelift
Abdominoplasty



**Wundhaken
Retractors
Separadores
Ecarteurs
Divaricatori**

A07



Farabeuf-Baby

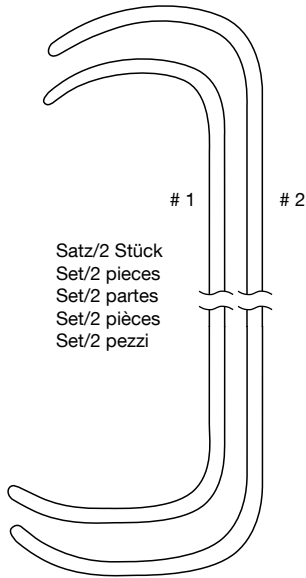

Satz/2 Stück
Set/2 pieces
Set/2 partes
Set/2 pièces
Set/2 pezzi

# 1	# 2
A = 10 × 25 mm	A = 10 × 30 mm
B = 17 × 32 mm	B = 17 × 35 mm
12 cm - 4¾"	
22.10.12	



Farabeuf

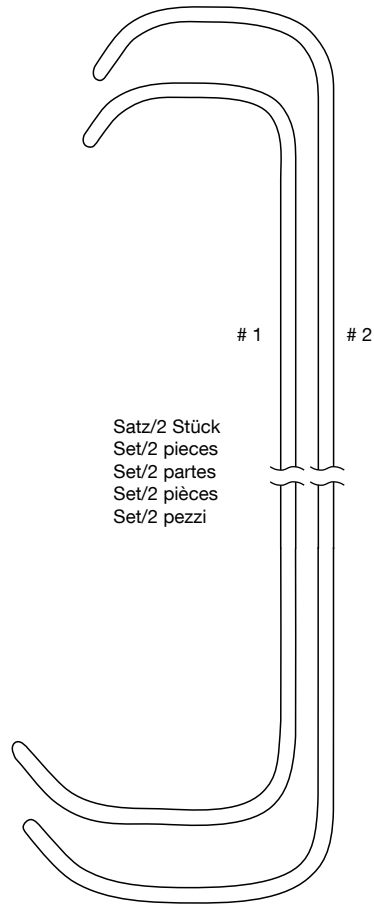

Satz/2 Stück
Set/2 pieces
Set/2 partes
Set/2 pièces
Set/2 pezzi

# 1	# 2
A = 16 × 30 mm	A = 16 × 33 mm
B = 16 × 33 mm	B = 16 × 42 mm
15 cm - 6"	
22.10.15	



Langenbeck

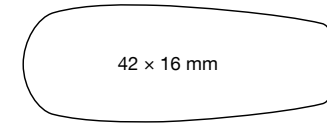

21 cm - 8¼"
23.06.16

21 cm - 8¼"
23.06.13

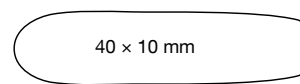
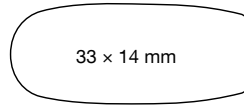

21 cm - 8¼"
23.06.12

21 cm - 8¼"
23.06.10



Kocher

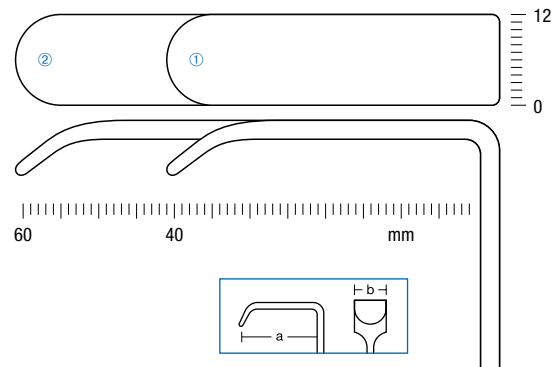

①	23.21.01	22 cm - 8¾"	a = 40 mm	b = 12 mm
②	23.21.02	22 cm - 8¾"	a = 60 mm	b = 12 mm



**Wundhaken
Retractors
Separadores
Ecarteurs
Divaricatori**

A07

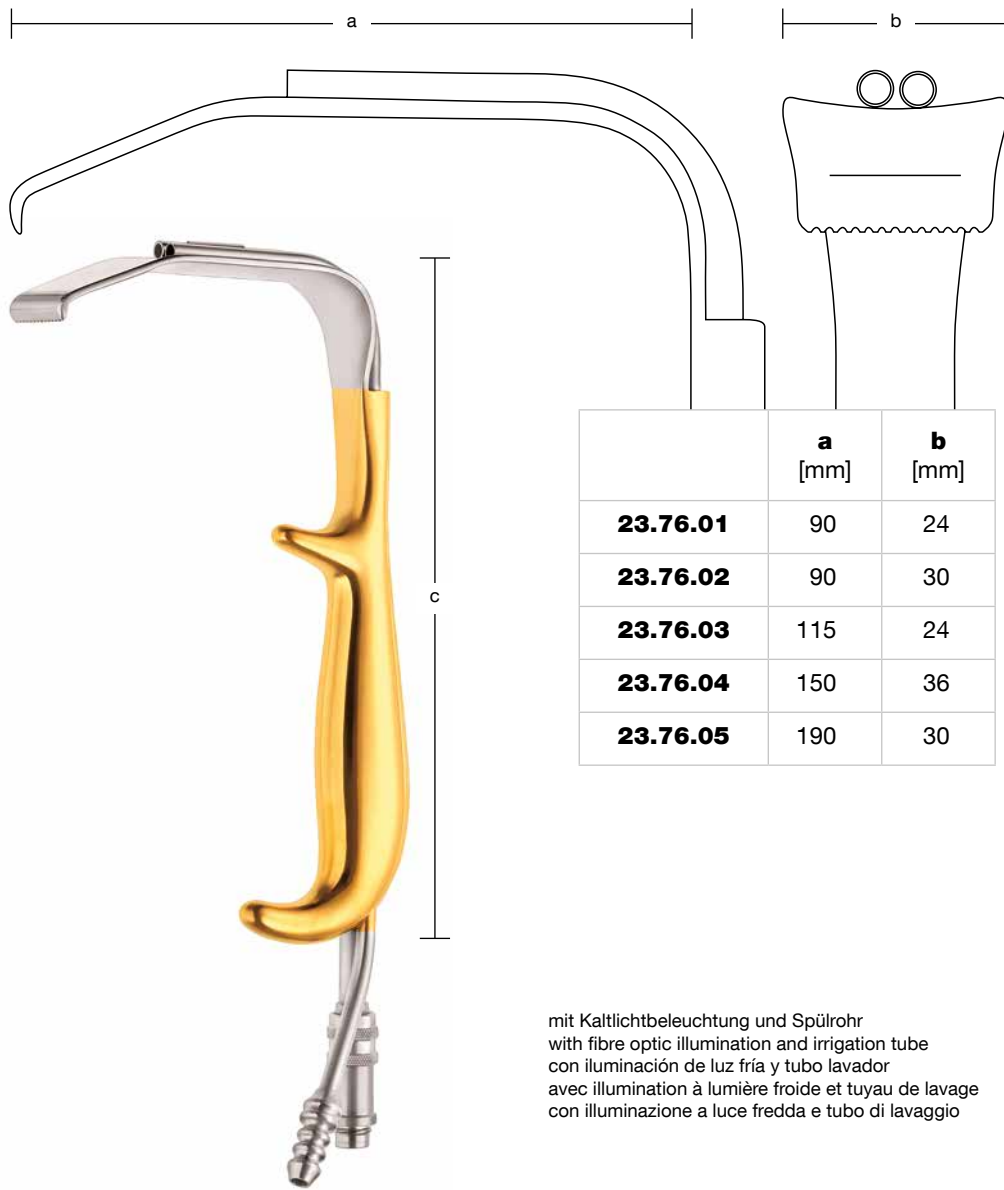

	a [mm]	b [mm]
23.76.01	90	24
23.76.02	90	30
23.76.03	115	24
23.76.04	150	36
23.76.05	190	30

c = 18,5 cm - 7¼"

Tebbetts

inklusive Adapter zum Anschluß für Lichtleitkabel
including adapter for connection to fibre optic cable
con adaptador para la conexión del cable conductor de luz
avec adaptateur pour la connexion du câble conducteur de lumière
compreso adattatore per l'attacco di cavo conduttore di luce

mit Kaltlichtbeleuchtung und Spülrohr
with fibre optic illumination and irrigation tube
con iluminación de luz fría y tubo lavador
avec illumination à lumière froide et tuyau de lavage
con illuminazione a luce fredda e tubo di lavaggio

ACMI · MEDICON · WOLF · STORZ

Lidhalter
Lid retractors
Separadores para párpados
Releveurs à paupières
Elevatori per palpebre

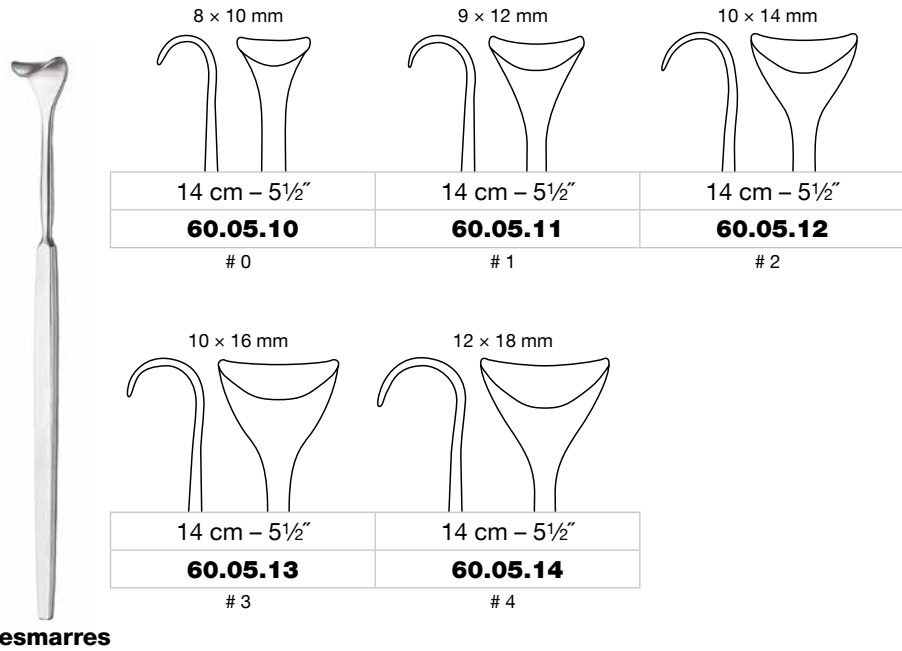

Unterkieferrand-Retraktor
Mandibular rim retractor
Separador para el borde del maxilar inferior
Ecarteur pour le bord du maxillaire inférieur
Divaricatore per il bordo della mascella inferiore

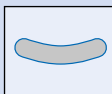
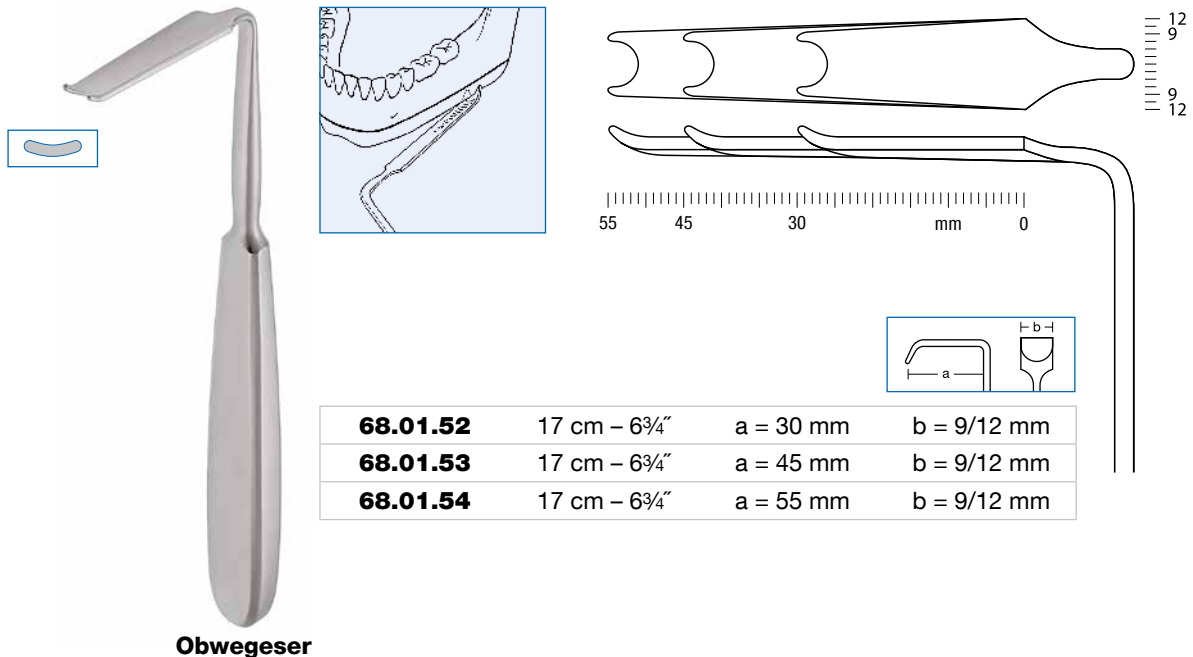

Wundhakenblatt, gewölbt
Retractor blade, curved
Hoja de separador, abovedada
Lame d'écarteur, courbée
Valva convessa



**Wundhaken
Retractors
Separadores
Ecarteurs
Divaricatori**

A07

Ramushaken
Ramus retractors
Separadores para el ramo
Ecarteurs à rameau
Divaricatori per ramo

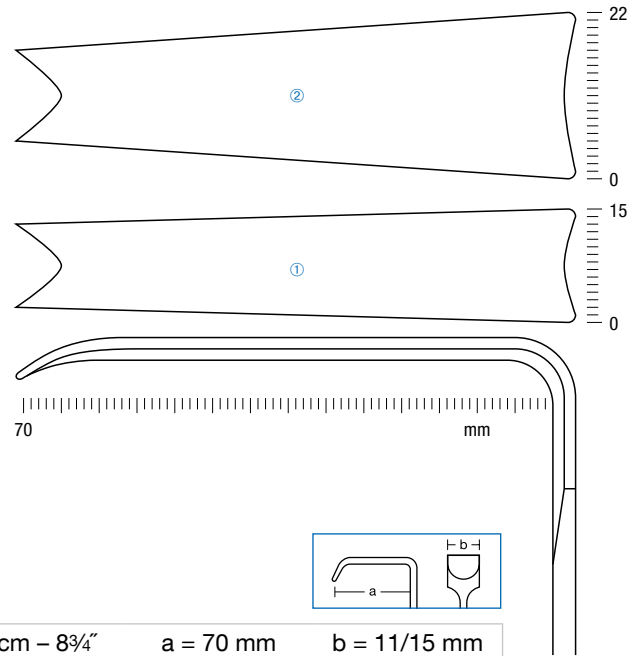
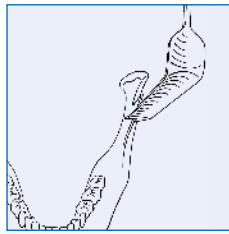

①	68.01.56	22 cm – 8¾"	a = 70 mm	b = 11/15 mm
②	68.01.57	22 cm – 8¾"	a = 70 mm	b = 12/22 mm

Obwegeser

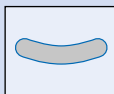

Wundhakenblatt, gewölbt
Retractor blade, curved
Hoja de separador, abovedada
Lame d'écarteur, courbée
Valva convessa

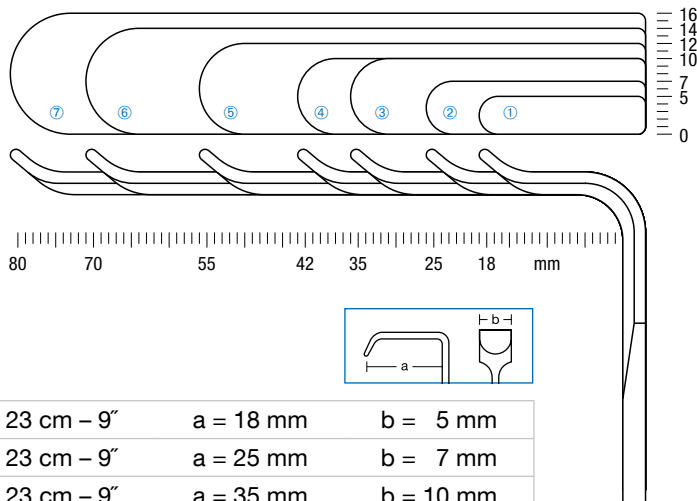
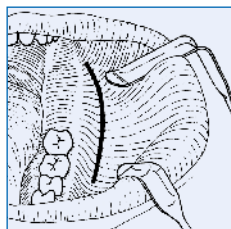

①	68.01.31	23 cm – 9"	a = 18 mm	b = 5 mm
②	68.01.32	23 cm – 9"	a = 25 mm	b = 7 mm
③	68.01.33	23 cm – 9"	a = 35 mm	b = 10 mm
④	68.01.34	23 cm – 9"	a = 42 mm	b = 10 mm
⑤	68.01.35	23 cm – 9"	a = 55 mm	b = 12 mm
⑥	68.01.36	23 cm – 9"	a = 70 mm	b = 14 mm
⑦	68.01.37	23 cm – 9"	a = 80 mm	b = 16 mm

Obwegeser

Weichteilhaken
Soft tissue retractors
Separadores para partes blandas
Ecarteurs pour parties molles
Divaricatori per tessuti molli

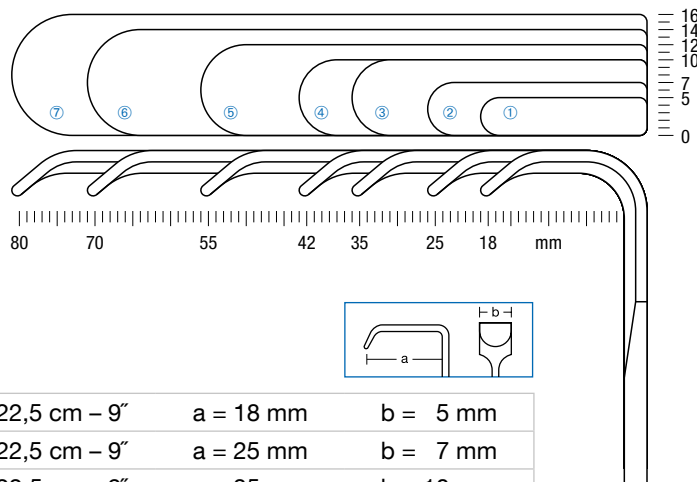
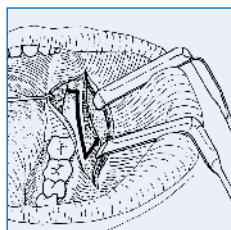

①	68.01.41	22,5 cm – 9"	a = 18 mm	b = 5 mm
②	68.01.42	22,5 cm – 9"	a = 25 mm	b = 7 mm
③	68.01.43	22,5 cm – 9"	a = 35 mm	b = 10 mm
④	68.01.44	22,5 cm – 9"	a = 42 mm	b = 10 mm
⑤	68.01.45	22,5 cm – 9"	a = 55 mm	b = 12 mm
⑥	68.01.46	22,5 cm – 9"	a = 70 mm	b = 14 mm
⑦	68.01.47	22,5 cm – 9"	a = 80 mm	b = 16 mm

Obwegeser

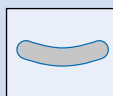

Wundhakenblatt, gewölbt
Retractor blade, curved
Hoja de separador, abovedada
Lame d'écarteur, courbée
Valva convessa



**Wundhaken
Retractors
Separadores
Ecarteurs
Divaricatori**

A07

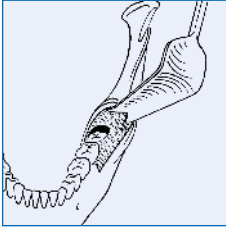

Weisheitszahnhaken
Wisdom tooth retractor
Separador para muela del juicio
Ecarteur pour dent de sagesse
Divaricatore per dente del giudizio

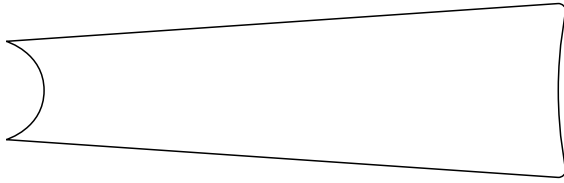

a = 70 mm
b = 13/23 mm
22 cm - 8 3/4"
68.01.63



Obwegeser

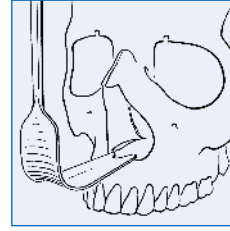

Spina-nasalis-Haken
Nasal spine retractor
Separador para espina nasal
Ecarteur d'épine nasale
Separatore per spina nasale

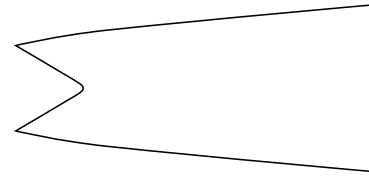

a = 45 mm
b = 10/23 mm
22 cm - 8 3/4"
68.01.65

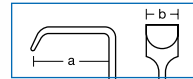

Obwegeser

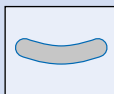

Wundhakenblatt, gewölbt
Retractor blade, curved
Hoja de separador, abovedada
Lame d'écarteur, courbée
Valva convessa

Beckenkamm-Retraktoren
Iliac crest retractors
Separadores para cresta iliaca
Ecarteurs pour la crête iliaque
Divaricatori per la cresta iliaca



Obwegeser

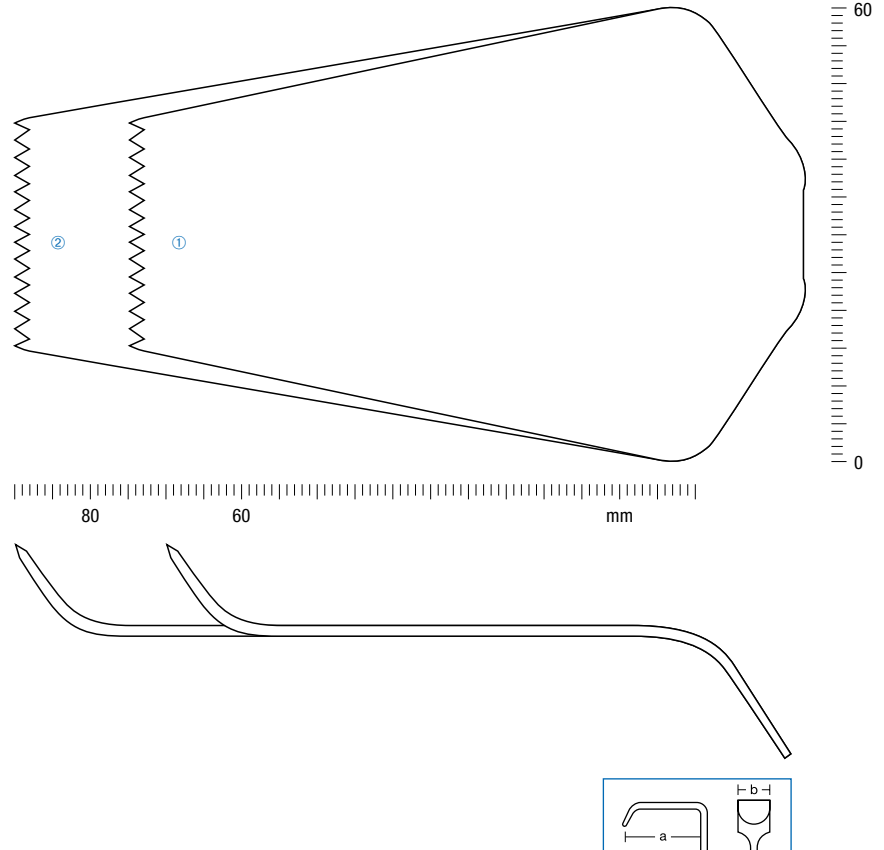

①	68.01.67	22 cm – 8¾"	a = 60 mm	b = 30/60 mm
②	68.01.68	22 cm – 8¾"	a = 80 mm	b = 30/60 mm



451.06.90

Unser komplettes "Cristaca"-Programm finden Sie in unserem Sonderprospekt.
For our complete "Cristaca" line, see our special brochure.
El programa completo "Cristaca" se encuentra en nuestro folleto especial.
Vous trouverez notre programme complet "Cristaca" dans notre prospectus spécial.
Troverete il nostro programma completo "Cristaca" nel nostro depliant speciale.



**Wundhaken
Retractors
Separadores
Ecarteurs
Divaricatori**

A07



Progenie-Rinnen
Channel retractors
Separadores mandibulares
Ecarteurs mandibulaires
Divaricatori mandibolari

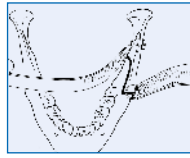

Obwegeser

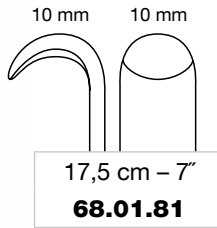
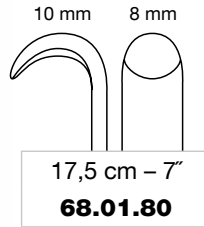

Kinnhalter
Chin retractor
Gancho de mentón
Fixe-menton
Gancio per mento

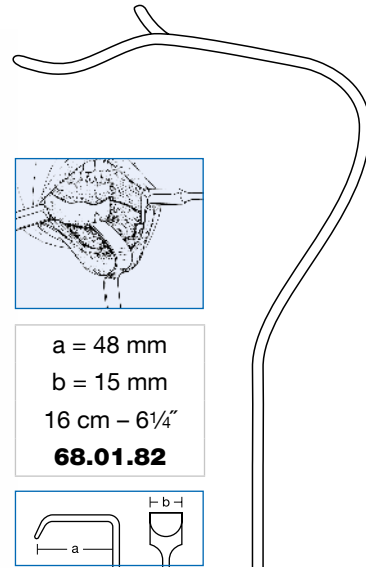
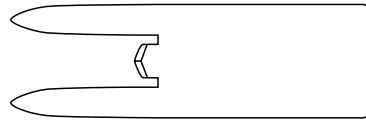

Obwegeser

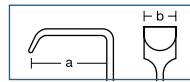
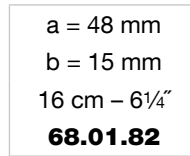
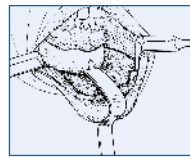

Wundspreizer
Self-retaining Retractors
Separadores autoestáticos
Ecarteurs autostatiques
Divaricatori autostatici

A08

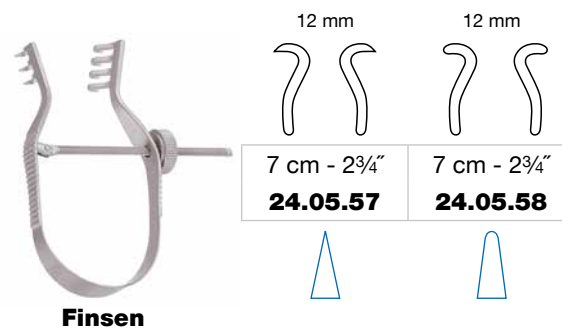
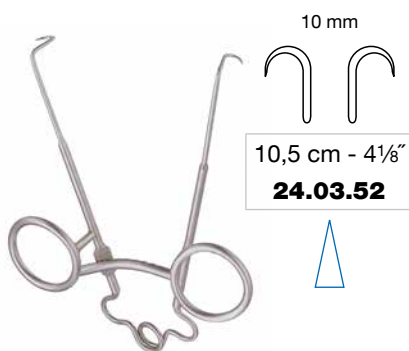
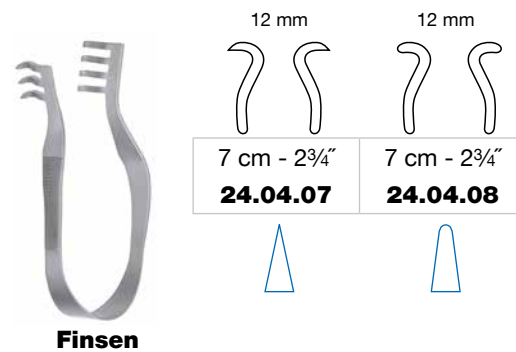
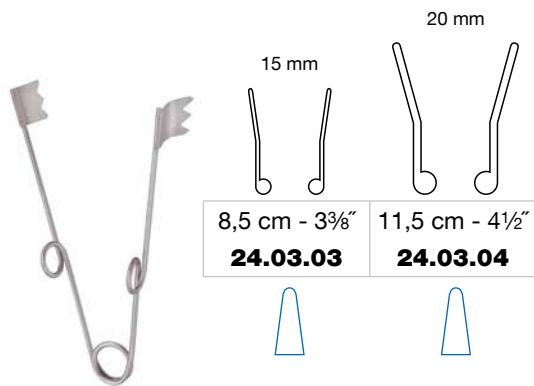
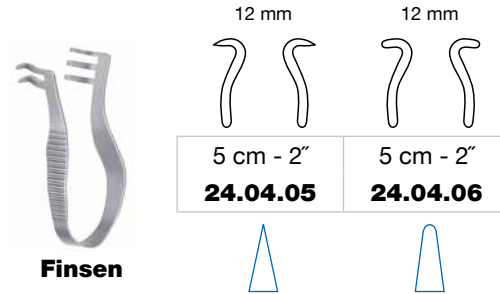
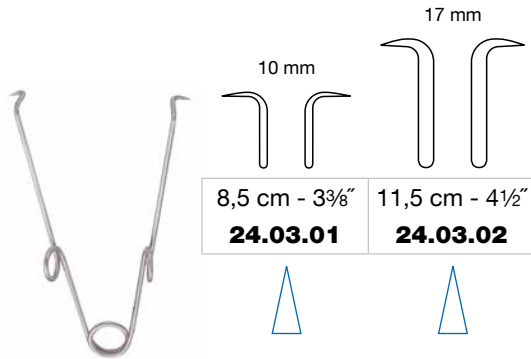

spitz
sharp
aguda
pointu
acuta

stumpf
blunt
roma
mousse
smussa



A08

Wundspreizer
Self-retaining Retractors
Separadores autoestáticos
Ecarteurs autostatiques
Divaricatori autostatici



Alm

5 mm	5 mm	6 mm	6 mm
7 cm - 2¾"	7 cm - 2¾"	10 cm - 4"	10 cm - 4"
24.10.07	24.10.08	24.10.10	24.10.11



6 mm	6 mm
10 cm - 4"	10 cm - 4"
24.09.09	24.09.10



Weitlaner

15 mm	15 mm	15 mm
10,5 cm - 4⅛"	10,5 cm - 4⅛"	10,5 cm - 4⅛"
24.22.10	24.22.11	24.22.12



Weitlaner

18 mm
13 cm - 5⅛"
24.22.03



scharf
sharp
aguda
pointu
acuta



halbscharf
semi sharp
semi aguda
semi pointu
semi acuta



stumpf
blunt
roma
mousse
smussa

Wundspreizer
Self-retaining Retractors
Separadores autoestáticos
Ecarteurs autostatiques
Divaricatori autostatici

A08

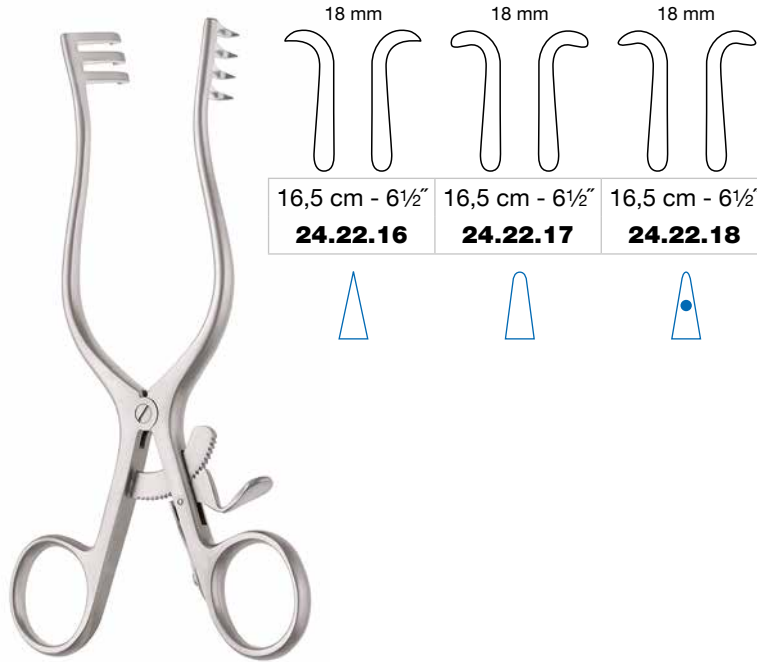

Weitlaner

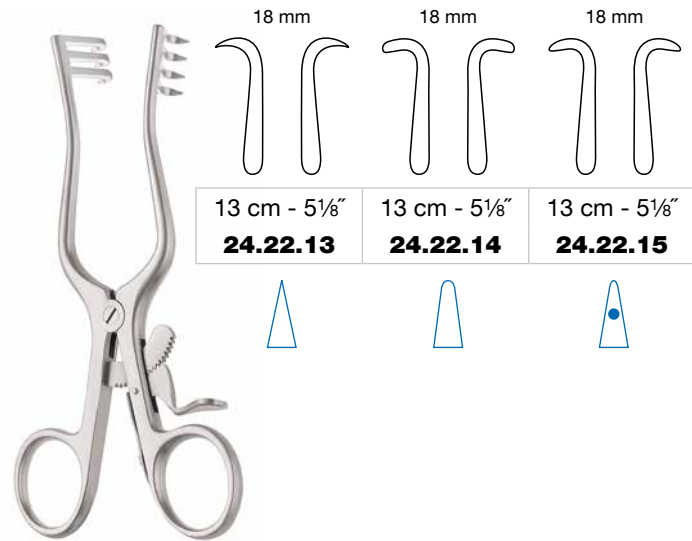

Weitlaner



scharf
sharp
aguda
pointu
acuta



halbscharf
semi sharp
semi aguda
semi pointu
semi acuta



stumpf
blunt
roma
mousse
smussa

www.medicon.de



**Spezialinstrumente
Special Instruments
Instrumentos especiales
Instruments spéciaux
Strumenti speciali**

B

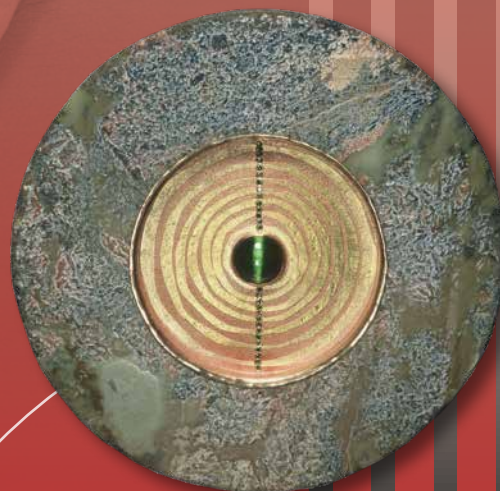

Z O B E L



B01

**Elevatori
Elevators
Elevadores
Elévateurs
Elevatori**

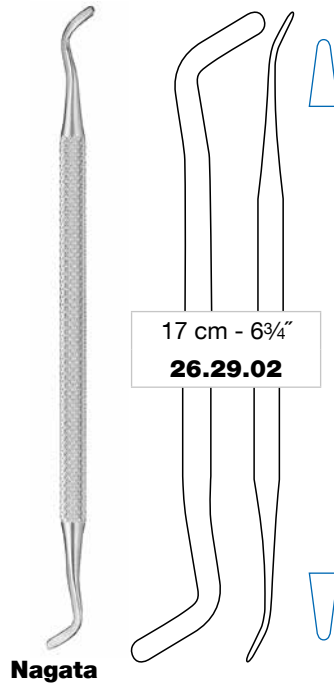
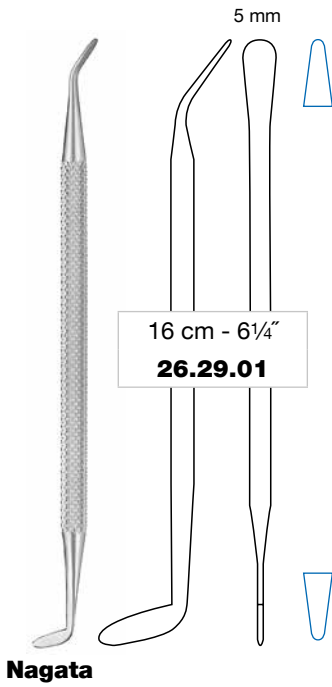

Entnahme von Rippenknorpel
Harvesting of costal cartilages
Toma de cartilago de costilla
Prélèvement de cartilage costal
Prelievo di cartilagine costale

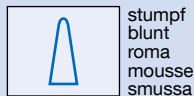
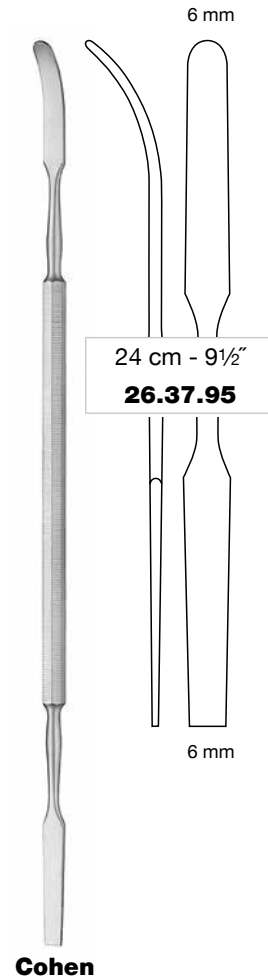
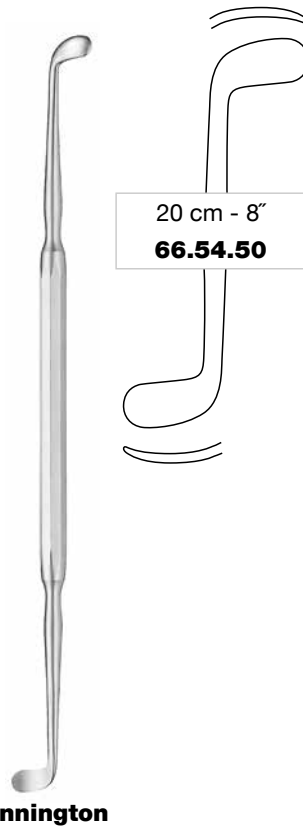



17,5 cm - 7"
26.48.10

Daniel-Gubisch

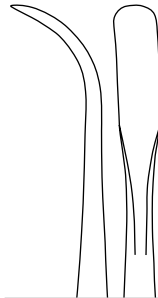

17 cm - 6¾"
26.48.12

Daniel-Gubisch

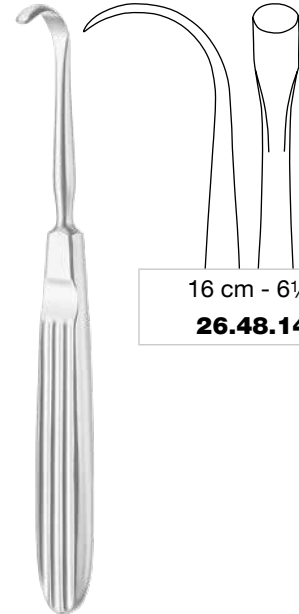

16 cm - 6¼"
26.48.14

Daniel-Gubisch

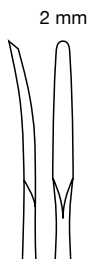

2 mm

17 cm - 6¾"
26.44.22



3 mm

17 cm - 6¾"
26.44.23



4 mm

17 cm - 6¾"
26.44.24



5 mm

17 cm - 6¾"
26.44.25



3,5 mm

17 cm - 6¾"
26.44.28

Lempert



Raspatorien
Raspatories
Legras
Rugines
Periostotomi

B01



Daniel-Gubisch

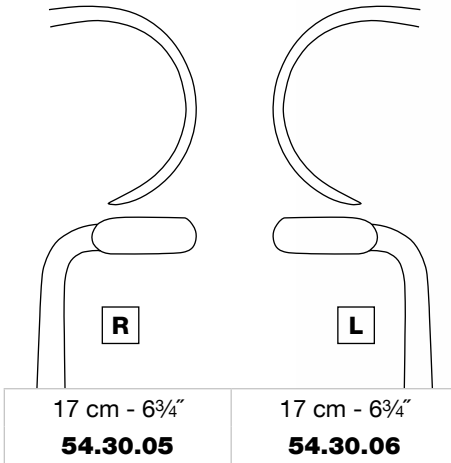

17 cm - 6³/₄" **54.30.05** 17 cm - 6³/₄" **54.30.06**

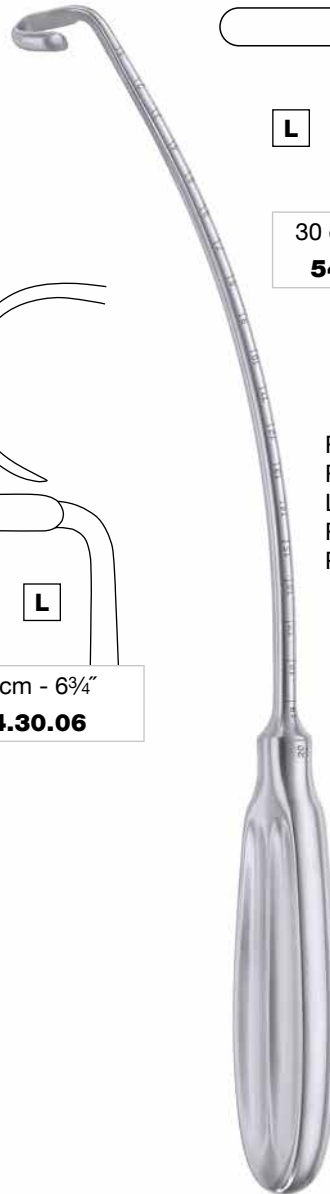

Obwegeser

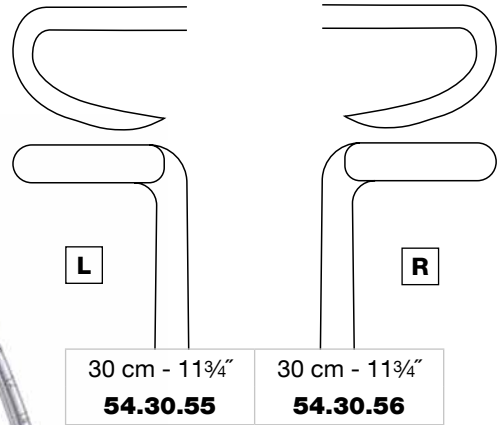

30 cm - 11³/₄" **54.30.55** 30 cm - 11³/₄" **54.30.56**

Rippen-Raspatorien
Rib raspatories
Legras para costillas
Rugines costales
Periostotomi per le costole

L links
left
izquierdo
gauche
sinistro

R rechts
right
derecho
droite
destro

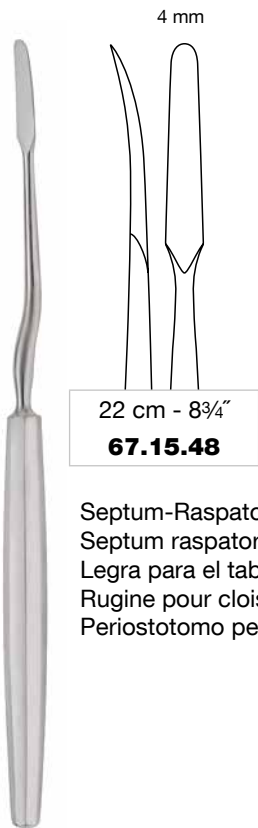

4 mm
22 cm - 8¾"
67.15.48

Septum-Raspatorium
Septum raspatory
Legra para el tabique nasal
Rugine pour cloison nasale
Periostotomo per il setto nasale

Joseph-Masing



8 mm
19 cm - 7½"
67.15.50

Cottle



5 mm
18 cm - 7¼"
67.15.65

Converse

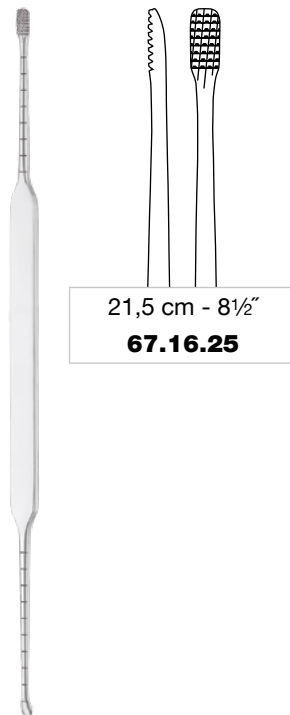

21,5 cm - 8½"
67.16.25

Daniel-Gubisch

Löffel
Curettes
Cucharillas
Curettes
Cucchiai

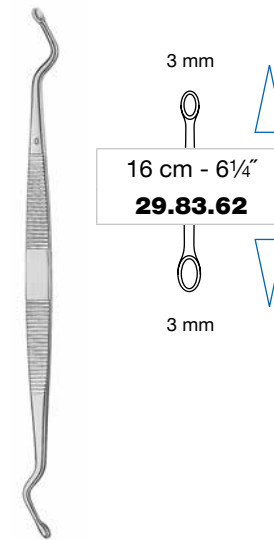

3 mm
16 cm - 6¼"
29.83.62
3 mm

Williger

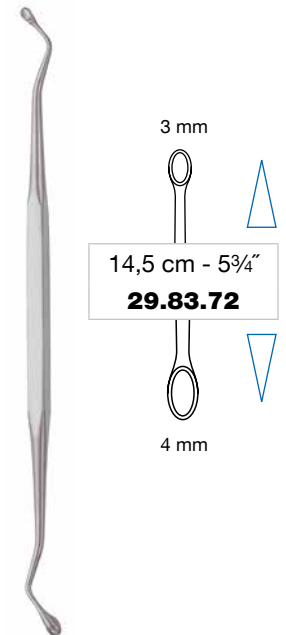

3 mm
14,5 cm - 5¾"
29.83.72
4 mm

Jansen



scharf
sharp
cortante
tranchant
tagliente



Raspatorien
Raspatories
Legras
Rugines
Periostotomi

B01



	17,5 cm - 7"
a = 6 mm	68.02.01
a = 7 mm	68.02.02
a = 9 mm	68.02.03
a = 11 mm	68.02.04

Obwegeser



9 mm

18 cm - 7 1/8"
68.02.05

Hargis

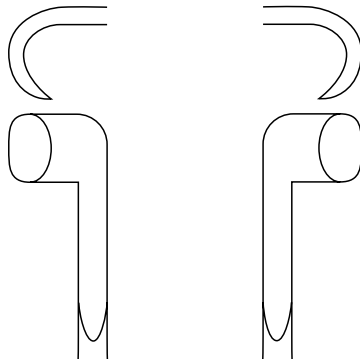

18 cm - 7 1/8" 68.02.06	18 cm - 7 1/8" 68.02.07
-----------------------------------	-----------------------------------

Linke Seite
Left side
Lado izquierdo
Côté gauche
Parte sinistra

Rechte Seite
Right side
Lado derecho
Côté droite
Parte destra



Obwegeser



9 mm

17,5 cm - 7"
68.02.08



Obwegeser



Obwegeser

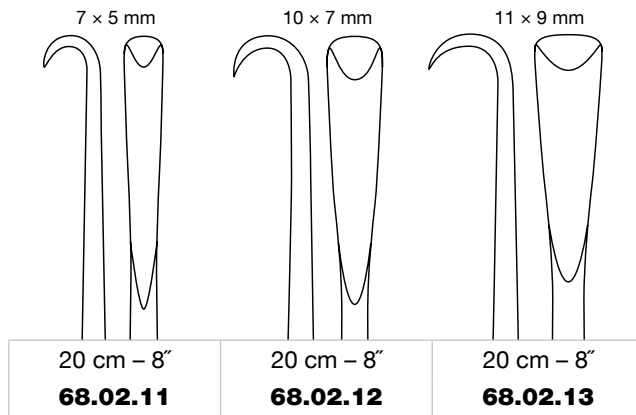

Dingman

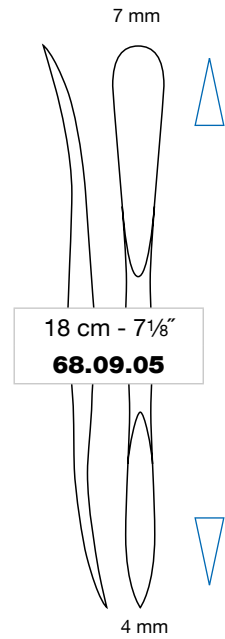

Obwegeser

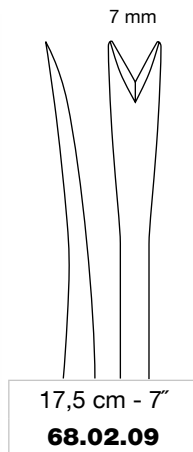

Obwegeser

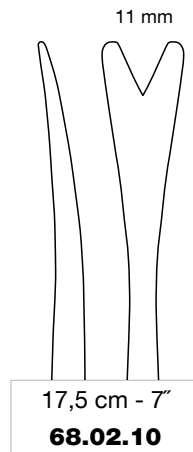

Obwegeser

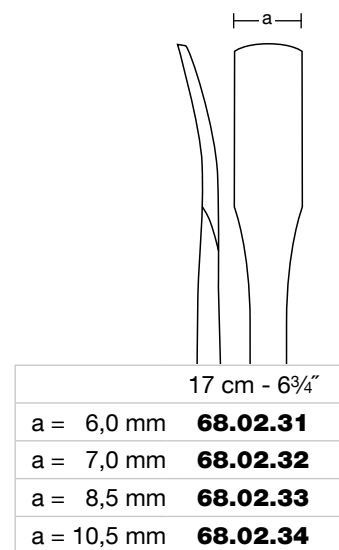

scharf
sharp
cortante
tranchant
tagliente



Raspatorien
Raspatories
Legras
Rugines
Periostotomi

B01



Obwegeser-Freer

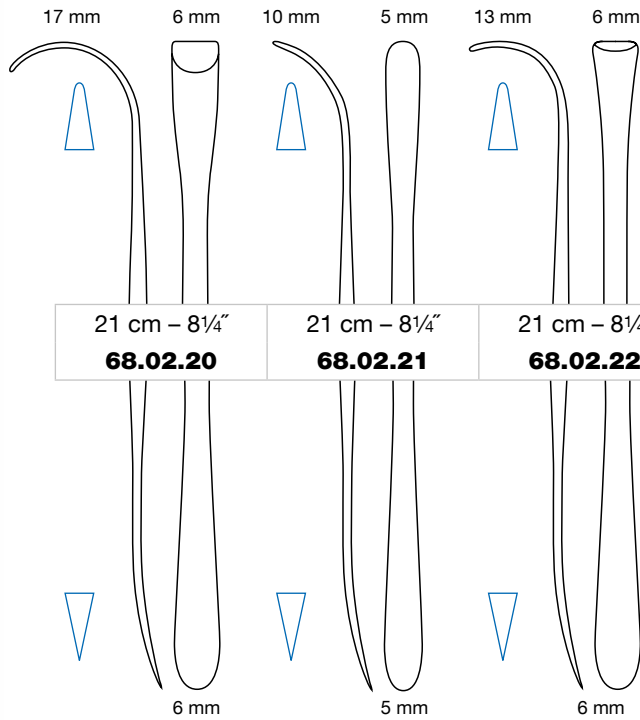

Tessier

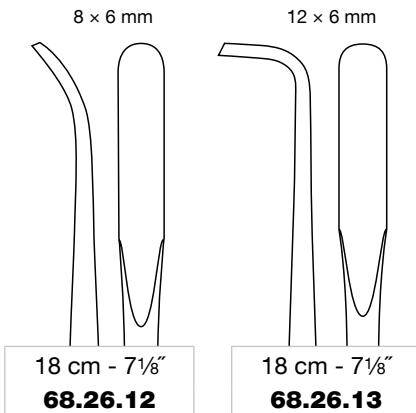

Steinhäuser

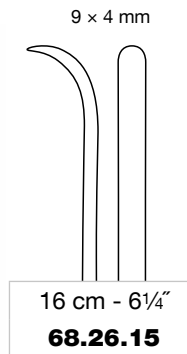

Orbitaboden-Raspatorium
Orbital floor raspatory
Legra para el piso de la órbita
Rugine pour le fond orbital
Periostotomo per il pavimento orbitale



scharf
sharp
cortante
tranchant
tagliente



stumpf
blunt
roma
mousse
smussa

flexibel
flexible
flexible
flexible
flexible
flessibile

21 cm – 8¼"

a = 8 mm	68.03.34
a = 10 mm	68.03.35

Obwegeser

10 mm

23 cm - 9"

68.03.30

Obwegeser

Tuber Osteotom
 Pterygoid osteotome
 Osteótomo pterigoideo
 Ostéotome pterigoïde
 Osteotomo per tubercolo

15 cm – 6"

a = 2,5 mm	68.03.02
a = 4,0 mm	68.03.04
a = 6,5 mm	68.03.39

Interdentale Osteotome
 Interdental osteotomes
 Osteótomos interdentes
 Ostéotomes interdentes
 Osteotomi interdentali

Obwegeser

**B02**

Osteotome
Osteotomes
Osteótomos
Ostéotomes
Osteotomi



PROPYLUX

- ▶ Ein biokompatibler Kunststoff der neuesten Thermoplast-Generation
- ▶ Extrem formbeständig bei häufiger Autoklavierung
- ▶ A biocompatible plastic from the latest generation of thermoplastics
- ▶ Extremely high dimensional stability with frequent autoclaving
- ▶ Un plástico biocompatible de la última generación de termoplásticos
- ▶ Extremadamente resistente a deformaciones en esterilizaciones en autoclave frecuentes
- ▶ Un plastique biocompatible de la toute dernière génération des thermoplastiques
- ▶ Extrêmement résistant aux déformations en cas de passages fréquents à l'autoclave
- ▶ Una plastica biocompatibile della più recente generazione di termoplastiche
- ▶ Estremamente resistente a deformazioni anche con trattamento frequente in autoclave

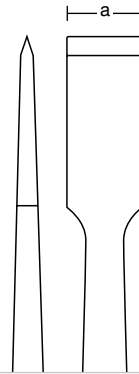
**Obwegeser**

21,5 cm – 8½"

a = 7 mm **68.03.07P**a = 10 mm **68.03.10P**

Spaltosteotome
 Splitting osteotomes
 Osteótomos para hender hueso
 Ostéotomes à fendre
 Osteotomi per fendere osso

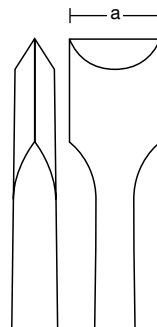
**Obwegeser**

22 cm – 8¾"

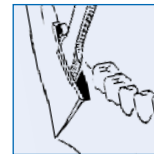
a = 8 mm **68.03.12P**a = 12 mm **68.03.13P**a = 16 mm **68.03.14P**

Keilosteotome
 Wedge osteotomes
 Osteótomos de cuña
 Ostéotomes cunéiformes
 Osteotomi a forma di cuneo



Kunststoffgriff (autoklavierbar bis 134 °C bei 3 bar)
 Plastic handle (autoclavable up to 134 °C at 3 bar)
 Mango de plástico (autoclavable hasta 134 °C bajo presión de 3 bar)
 Manche en plastique (autoclavable à 134 °C sous pression de 3 bars)
 Manico di plastica (autoclavabile fino a 134 °C sotto pressione di 3 bar)



22 cm - 8¾"	
a = 8 mm	68.03.16P
a = 12 mm	68.03.17P
a = 16 mm	68.03.18P
a = 20 mm	68.03.19P

Blattosteotome
 Blade osteotomes
 Osteótomos en forma de hoja
 Ostéotomes en lame
 Osteotomi a forma di lama

Obwegeser



Tessier

	16 cm - 6¼"		16 cm - 6¼"	
a = 10 mm	68.03.60	68.03.61		
a = 15 mm	68.03.62	68.03.63		



Tessier

	20,5 cm - 8"		20,5 cm - 8"	
a = 10 mm	68.03.50	68.03.51		
a = 15 mm	68.03.52	68.03.53		
a = 20 mm	68.03.54			
a = 30 mm	68.03.56			

**B02**

Zylinder-Osteotome
Cylinder Osteotomes
Osteótomos cilíndricos
Ostéotomes cylindriques
Osteotomi cilindrici

“SHEPARD” CYLINDER OSTEOTOMES

Kortikalisstanze
 Cortical cutter
 Punzonadora cortical
 Perforateur cortical
 Perforatore corticale



Shepard	12 cm – 4¾"	78.41.02	Ø 12 mm
----------------	-------------	-----------------	---------

Zylinder-Osteotome
 Cylinder osteotomes
 Osteótomos cilíndricos
 Ostéotomes cylindriques
 Osteotomi cilindrici



Shepard	12,5 cm – 5"	78.41.05	Ø 5 mm
	12,5 cm – 5"	78.41.06	Ø 6 mm
	12,5 cm – 5"	78.41.08	Ø 8 mm

Ausstoßer
 Rams
 Expulsores
 Pousoirs
 Espulsori



Shepard	14,0 cm – 5½"	78.41.12	Ø 5 mm
	14,0 cm – 5½"	78.41.13	Ø 6 mm
	14,0 cm – 5½"	78.41.14	Ø 8 mm

Trokare
 Trocars
 Trocares
 Trocart
 Trocar



Shepard	14,5 cm – 5¾"	78.41.15	Ø 5 mm
	14,5 cm – 5¾"	78.41.16	Ø 6 mm
	14,5 cm – 5¾"	78.41.18	Ø 8 mm

Querstift
 Cross pin
 Espiga transversal
 Embout transversal
 Perno trasversale

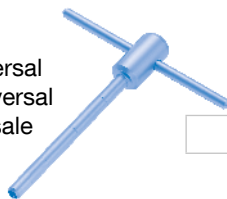

Shepard	11 cm – 4¾"	78.41.11	Ø 6 mm
----------------	-------------	-----------------	--------

zum Drehen der Zylinder-Osteotome
 for turning cylinder osteotomes
 para girar osteótomos cilíndricos
 pour la rotation de l'ostéotome cylindrique
 per la rotazione degli osteotomi cilindrici

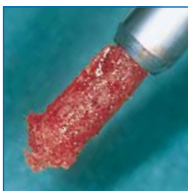

Orbital-Osteotome, Maxilla-Mobilisator
Orbital Osteotomes, Maxilla Mobilizer
Osteótomos para orbita, Movilizador maxilar
Ostéotomes orbitaux, Mobilisateur pour maxillaire
Osteotomi orbitali, Mobilizzatore per mascella

B02

Orbital-Osteotome
 Orbital osteotomes
 Osteótomos para orbita
 Ostéotomes orbitaux
 Osteotomi orbitali



Steinhäuser

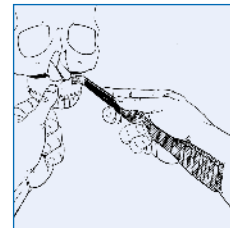
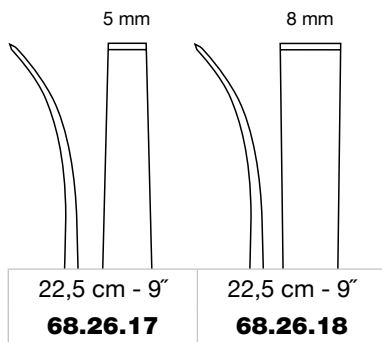

Maxilla-Mobilisator
 Maxilla mobilizer
 Movilizador maxilar
 Mobilisateur pour maxillaire
 Mobilizzatore per mascella



Obwegeser

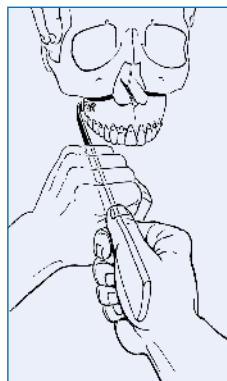
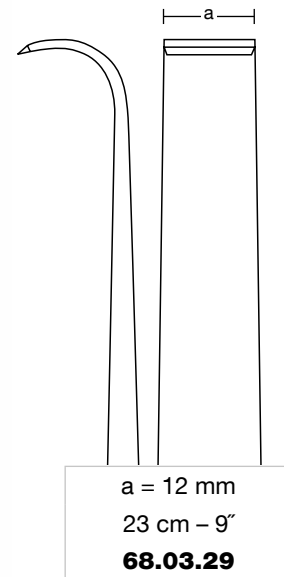



B03

Knorpel- und Knocheninstrumente
Cartilage and Bone Instruments
Instrumentos para cartilago y huesos
Instrumenti à cartilage et os
Strumenti per cartilagine e ossa



Knochenformzangen
 Bone bending pliers
 Pinzas para doblar huesos
 Pincas plieuse pour os
 Pinze per piegare ossa

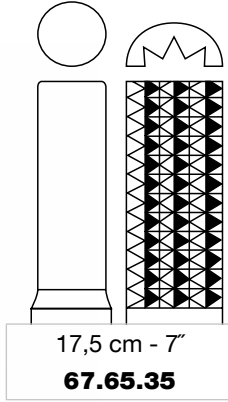

Obwegeser

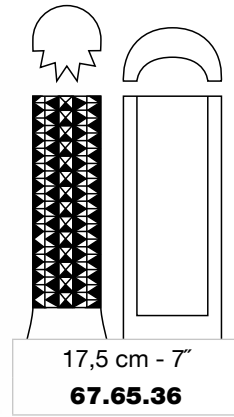

Obwegeser



Knochenmühle mit Montageschlüssel
 Bone mill with assembling wrench
 Trituradora de hueso con llave de montaje
 Moulin à os avec clé de montage
 Trita ossa con chiave per montaggio



1:1

Ø 68 mm
 11 cm – 4³/₈"
68.82.75

Ermöglicht ein Zerkleinern von Knochenstücken
 Enables crushing of compact bone pieces
 Permite moler fragmentos óseos
 Pour broyage de fragments d'os
 Rende possibile triturare frammenti ossei



B04

Lippen- und Gaumenspalteninstrumente
Lip and Cleft Palate Instruments
Instrumentos para labios y fisuras paladares
Instruments pour lèvres et fissures palatines
Strumenti per labbra e fessure del palato



Blocksma

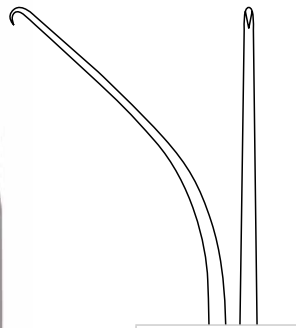

18 cm - 7 1/8"

68.81.31

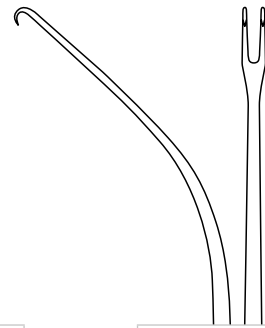

18 cm - 7 1/8"

68.81.32

Häkchen
 Hooks
 Ganchitos
 Crochets
 Uncini

Raspatorien
 Raspatories
 Legras
 Rugines
 Periostotomi

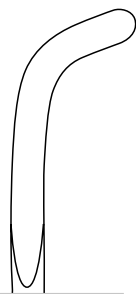

14 cm - 5 1/2"

68.82.11

L

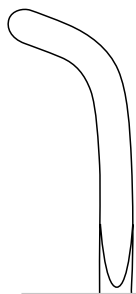

14 cm - 5 1/2"

68.82.12

R



Kahre



17 cm - 6 3/4"

68.82.20



McIndoe

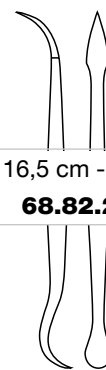

16,5 cm - 6 1/2"

68.82.25

L links
 left
 izquierdo
 gauche
 sinistro

R rechts
 right
 derecho
 droite
 destro

Lippen- und Gaumenspalteninstrumente
Lip and Cleft Palate Instruments
Instrumentos para labios y fisuras paladares
Instrumentes pour lèvres et fissures palatines
Strumenti per labbra e fessure del palato

B04

Muko-Periostal-Haken
 Mucoperiost retractors
 Separadores mucoperiostales
 Ecarteurs mucoperiostales
 Divaricatori mucoperiostali





Lippen- und Gaumenspalteninstrumente
Lip and Cleft Palate Instruments
Instrumentos para labios y fisuras paladares
Instruments pour lèvres et fissures palatines
Strumenti per labbra e fessure del palato

B04

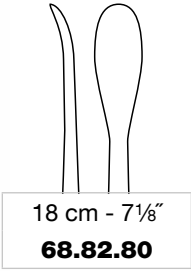

Wang

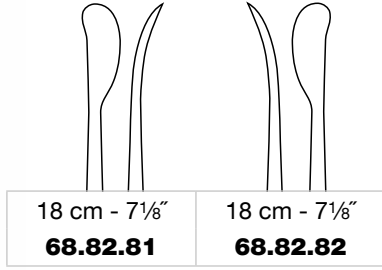

R

L

Wang

Raspatorien
 Raspatories
 Legras
 Rugines
 Periostotomi

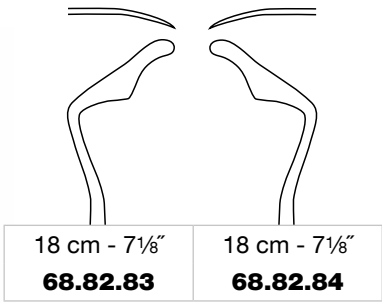

R

L

Wang

L links
 left
 izquierdo
 gauche
 sinistro

R rechts
 right
 derecho
 droite
 destro

Lippen- und Wangenhalter
Lip and Cheek Retractors
Separadores de labios y mejillas
Ecarteurs de lèvres et de joues
Divaricatori di labbra e guance

B05



für Oberkiefer
 for upper jaw
 para mandíbula superior
 pour mâchoire supérieure
 per mascella superiore

21 cm - 8¼"
68.01.97



für Unterkiefer
 for lower jaw
 para mandíbula inferior
 pour mâchoire inférieure
 per mascella inferiore

26 cm - 10¼"
68.01.98



Universal
 universal
 universal
 universel
 universale

15 cm - 6"
68.01.99



mit Zungendrucker
 with tongue depressor
 con bajalengua
 avec abaisse-langue
 con abbassalingua

15,5 cm - 6⅛"
72.02.10

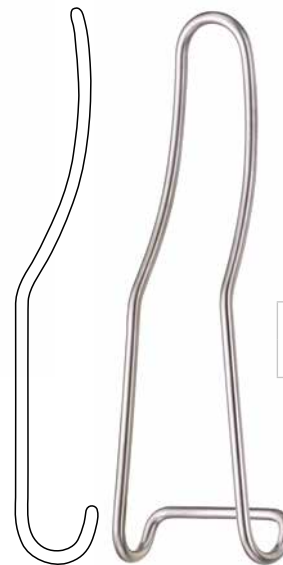

mit Zungendrucker
 with tongue depressor
 con bajalengua
 avec abaisse-langue
 con abbassalingua

14,5 cm - 5¾"
72.02.15

Sternberg

Univ. Minnesota Cawood



B06

Mundsperrer Mouth Gags Abrebocas Ouvre-bouches Apribocca



10 cm - 4"
72.05.10

für Kinder
for children
para niños
pour enfants
per bambini

15 cm - 6"
72.05.15

für Erwachsene
for adults
para adultos
pour adultes
per adulti

Molt

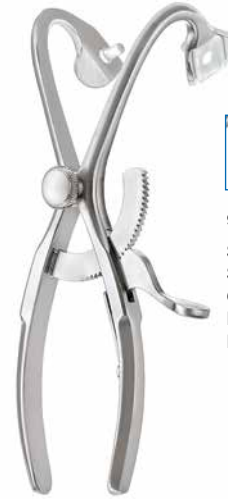

907.20.20

Silikonenschutz allein, Paar
Silicone guard only, pair
Goma de silicona sola, par
Protection en silicone seule, paire
Protezione di silicone sola, paio

Denhart

12,5 cm - 5"

72.05.61

Zungenspatel
Tongue spatulas
Espátulas bucales
Spatules à langue
Spatole per lingua

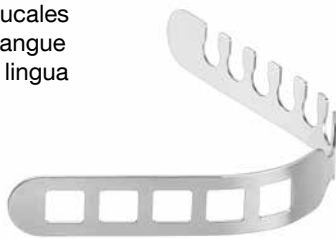

Hanna

20 cm - 8"

72.00.52

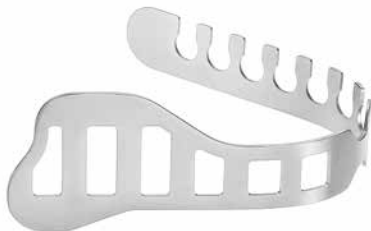

Claudinha

21 cm - 8¼"

72.00.56

Zungenspatel verwendbar nur
mit Mundsperrer:

Tongue spatulas only for use
with mouth gag:

Espátulas bucales sólo
aplicable con el abrebooca:

Spatules à langue seulement à
utiliser avec l'ouvre-bouche:

Spatole per lingua utilizzabile
solo con l'apribocca:

72.05.63

Denhart-Hoefert

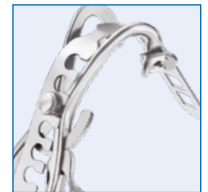

Auflagen, beweglich
Supports, movable
Soportes, móviles
Support, mobiles
Supporti, mobili

Denhart-Hoefert

12,5 cm - 5"

72.05.63

Mundsperrer
Mouth Gags
Abrebocas
Ouvre-bouches
Apribocca

B06

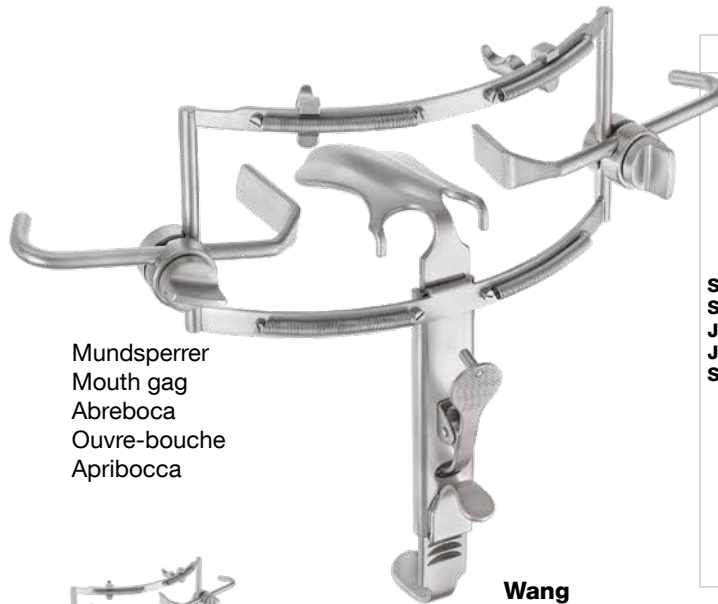

Mundsperrer
Mouth gag
Abreboca
Ouvre-bouche
Apribocca

Wang

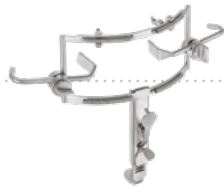

45.54.03

Rahmen, allein (ohne Zungendrücken)
Frame, only (without tongue depressors)
Bastidor, solo (sin bajalenguas)
Cadre, seul (sans abaisse-langues)
Telaio, solo (senza abbassalingua)

45.54.02

Satz bestehend aus:
Set consisting of:
Juego compuesto por:
Jeu composé de:
Set composto da:

Rahmen Frame Bastidor Cadre Telaio	1 x
Zahnhaken Tooth hooks Ganchos dentales Crochets dentaires Ganci dentali	2 x
Wangenhaken Cheek retractors Separadores para mejillas Ecarteurs pour joues Divaricatori per guancia	2 x
Zungendrücken Tongue depressors Bajalenguas Abaisse-langues Abbassalingua	1 x 45.54.05 1 x 45.54.06 1 x 45.54.07

Zungendrücken
Tongue depressors
Bajalenguas
Abaisse-langues
Abbassalingua



45.54.05	# 1	55 x 32 mm
45.54.06	# 2	65 x 35 mm
45.54.07	# 3	75 x 38 mm

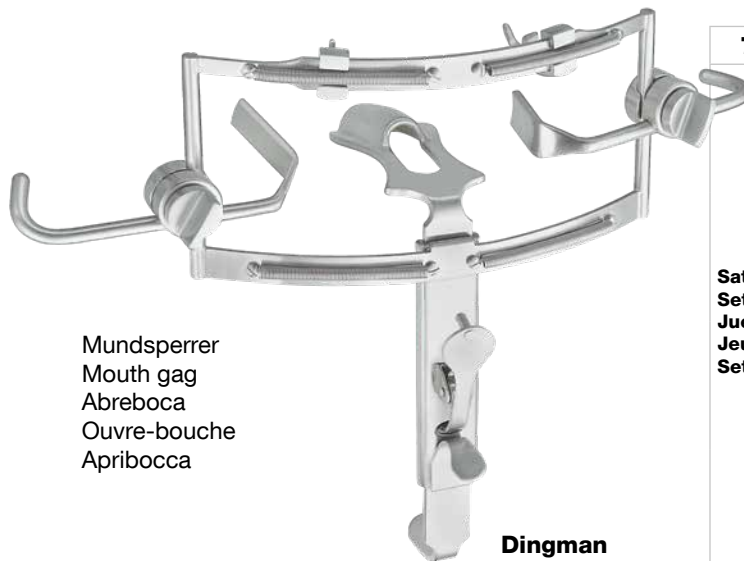

Mundsperrer
Mouth gag
Abreboca
Ouvre-bouche
Apribocca

Dingman

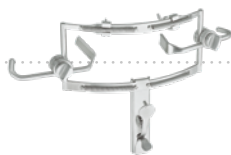

72.08.20

Rahmen, allein (ohne Zungendrücken)
Frame, only (without tongue depressors)
Bastidor, solo (sin bajalenguas)
Cadre, seul (sans abaisse-langues)
Telaio, solo (senza abbassalingua)

72.08.00

Satz bestehend aus:
Set consisting of:
Juego compuesto por:
Jeu composé de:
Set composto da:

Rahmen Frame Bastidor Cadre Telaio	1 x
Zahnhaken Tooth hooks Ganchos dentales Crochets dentaires Ganci dentali	2 x
Wangenhaken Cheek retractors Separadores para mejillas Ecarteurs pour joues Divaricatori per guancia	2 x
Zungendrücken Tongue depressors Bajalenguas Abaisse-langues Abbassalingua	1 x 72.08.11 1 x 72.08.12 1 x 72.08.13

Zungendrücken
Tongue depressors
Bajalenguas
Abaisse-langues
Abbassalingua



72.08.11	# 1	55 x 25 mm
72.08.12	# 2	60 x 27 mm
72.08.13	# 3	70 x 30 mm



Mundkeile
Mouth gags
Abrebocas
Baillons
Apribocca

B06



1:1

McKesson

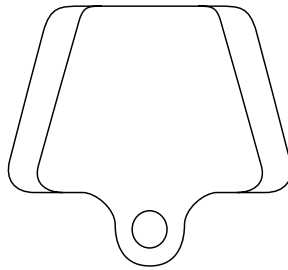

72.10.01



für Kleinkinder
for infants
para niños pequeños
pour petits enfants
per bambini piccoli

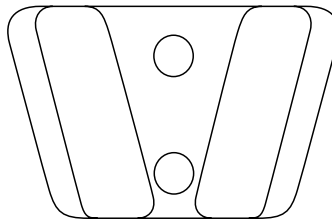

72.10.02



für Kinder
for children
para niños
pour enfants
per bambini

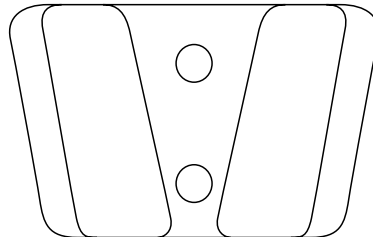

72.10.03



für Erwachsene
for adults
para adultos
pour adultes
per adulti

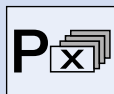

Verpackungseinheit "X" Stück
Packing unit "X" pieces
Paquete de "X" unidades
Emballage de "X" pièces
Confezione da "X" pezzi

Markierungs- und Messinstrumente
Marking and Measuring Instruments
Instrumentos para marcar y medir
Instrumenti à mesurer et marquer
Strumenti per marcare e misurare

B07

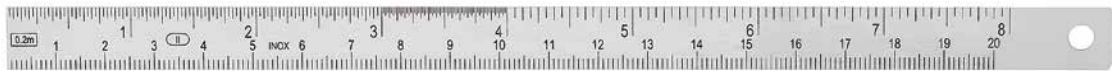

Stahllineale (rostfrei)
 Rulers (stainless steel)
 Reglas de acero (inoxidable)
 Règles en acier (inoxydable)
 Righelli in acciaio (inossidabile)

15 cm – 6"	44.37.15
20 cm – 8"	44.37.20
30 cm – 11¾"	44.37.30
50 cm – 19¾"	44.37.50

graduiert in mm und Zoll
 graduated in mm and inches
 graduado en mm y pulgadas
 graduée en mm et pouces
 graduato in mm e pollici



Winkelmesser
 Flexometer
 Goniómetro
 Goniomètre
 Goniometro

23,5 cm - 9¼"
44.38.10

zusammenlegbar
 fold up
 plegable
 pliable
 pieghevole

Möltgen

graduiert in mm und Zoll
 graduated in mm and inches
 graduado en mm y pulgadas
 graduée en mm et pouces
 graduato in mm e pollici

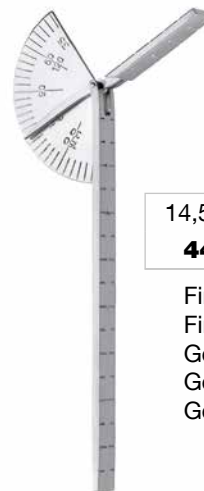

14,5 cm - 5¾"
44.38.30

Finger-Goniometer
 Finger goniometer
 Goniómetro para dedos
 Goniomètre pour doigts
 Goniometro per dita

Schieblehren
 Calipers
 Calibradores
 Pieds à coulisse
 Calibri micrometrici



9,5 cm - 3¾"
60.00.30

Jameson



11 cm - 4¾"
60.00.31

Thorpe

**B07**

Markierungs- und Messinstrumente
Marking and Measuring Instruments
Instrumentos para marcar y medir
Instrumenti à mesurer et marquer
Strumenti per marcare e misurare

**Gubisch**

Zur Markierung von Inzisionslinien auf der Haut/Schleimhaut.
 For the marking of incision lines on the skin/mucous membrane.
 Para marcar líneas de incisión en la piel/mucosa.
 Pour le repérage des traits d'incision sur la peau/la muqueuse.
 Per marcare le linee di incisione sulla cute e sulla mucosa.



P₁₀
44.90.72

Feder
 Pen
 Pluma
 Plume
 Piuma

13 cm - 5 1/8"
44.90.70

Federhalter
 Pen holder
 Porta-plumas
 Porte-plume
 Porta-piuma

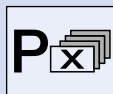
Gubisch

Verpackungseinheit "X" Stück
 Packing unit "X" pieces
 Paquete de "X" unidades
 Emballage de "X" pièces
 Confezione da "X" pezzi

Facelift-Markierer
 Facelift marker
 Marcador para facelift
 Marqueur pour facelift
 Marcatore per facelift

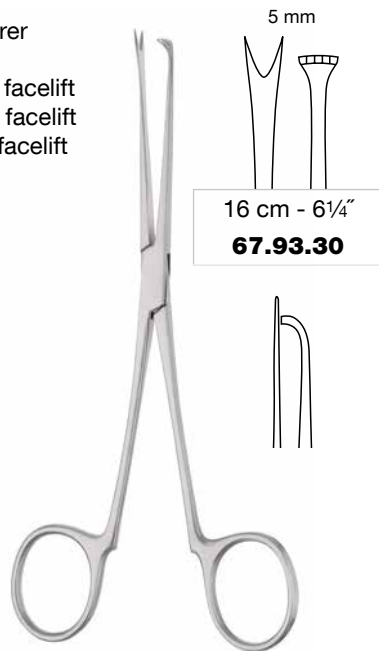

Pitanguy

Knochenmesszirkel
 Bone bow spacer
 Compás de hueso
 Compas à os
 Compasso per ossa



19,5 cm – 7¾"
44.38.40

für präzises Markieren der Resektionsmenge
 for a precise marking of the skin flap to be excised
 para una marcación del colgajo a resecar
 pour le marquage précis des parties de la peau à réséquer
 per una marcatura precisa del lembo cutaneo da resecare



Messzirkel
 Calipers
 Compases
 Compas
 Compassi



Castroviejo



Castroviejo

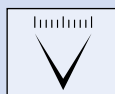

Messbereich
 Measuring range
 Alcance de medición
 Etendue de mesure
 Campo di misura



Markierungs- und Messinstrumente
Marking and Measuring Instruments
Instrumentos para marcar y medir
Instrumenti per misurare e marcare

B07



Messzirkel
Calipers
Compases
Compas
Compassi



40 mm
18 cm – 7 1/8" **60.00.42**

Castroviejo-Epker



40 mm
18 cm – 7 1/8" **60.00.43**

Castroviejo-Epker

Klapp-Okkludator
Model surgery articulator
Articulador para cirugía modelo
Articulateur pour chirurgie sur modèle
Articolatore per chirurgia modello



65 × 92 mm **68.05.05**

Obwegeser

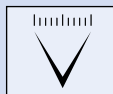

Messbereich
Measuring range
Alcance de medición
Etendue de mesure
Campo di misura

KRETSCHMER REFERENCE PIN

Referenz-Pin und Halterung
 Reference pin and holder
 Perno de referencia y soporte
 Pivot de référence et support
 Perno di referenza e sostegno

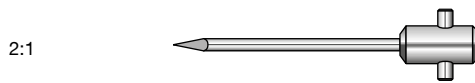

2:1

Kretschmer 2,0 cm – 3/4" **68.84.00** P



2:1

Kretschmer 1,6 cm – 3/4" ① **68.84.05**
 6,6 cm – 2 1/2" ② **68.84.06** P

Siebvorschlag bestehend aus:
 Set suggestions consisting of:
 Proposición de juego compuesto por:
 Proposition pour jeu se composant de:
 Proposta di set composto da:

68.84.00	Referenz-Pin Reference pin Perno de referencia Pivot de référence Perno di referenza
68.84.05	Halterung für Referenz-Pin Holder for reference pin Soporte para perno de referencia Support pour pivot de référence Sostegno per perno di referenza
44.38.40	Knochenmesszirkel Bone measuring dividers Compás para hueso Compas à os Compasso per ossa
44.37.20	Stahllineal (rostfrei) Ruler (stainless steel) Regla de acero (inoxidable) Règle en acier (inoxydable) Righello in acciaio (inossidabile)

Kompatibel mit Chirurgiehandstücke:
 Compatible with surgical hand pieces:
 Compatible con piezas de mano quirúrgica:
 Compatible avec pièces à main chirurgicale:
 Compatibile con manipoli chirurgici:



① **63.45.07**



② **63.45.11/13**

- ▶ Exakte Ermittlung der vertikalen Dimensionen durch festen Referenzpunkt
- ▶ Keine Irritationen des Referenzpunktes während der OP
- ▶ Einfache und exakte Endkontrolle der gewünschten vertikalen Position vor und während der Fixation
- ▶ Precise determination of vertical dimensions by a fixed reference point
- ▶ No irritation of the reference point during surgery
- ▶ Easy and precise final checking of the desired vertical position before and during fixation
- ▶ Determinación precisa de las dimensiones verticales gracias al punto de referencia fijo
- ▶ Ningún tipo de irritación del punto de referencia durante la intervención quirúrgica
- ▶ Sencillez y precisión de los controles finales de la posición vertical deseada, antes y durante la fijación
- ▶ Détermination précise des dimensions verticales grâce au point de référence fixe
- ▶ Aucune irritation du point de référence pendant l'intervention chirurgicale
- ▶ Simplicité et précision des contrôles finaux de la position verticale désirée, avant et pendant la fixation
- ▶ Determinazione precisa delle dimensioni verticali grazie al punto di referenza fisso
- ▶ Nessuna irritazione del punto di referenza durante l'intervento chirurgico
- ▶ Controllo finale semplice e preciso della posizione verticale desiderata, prima e durante la fissazione

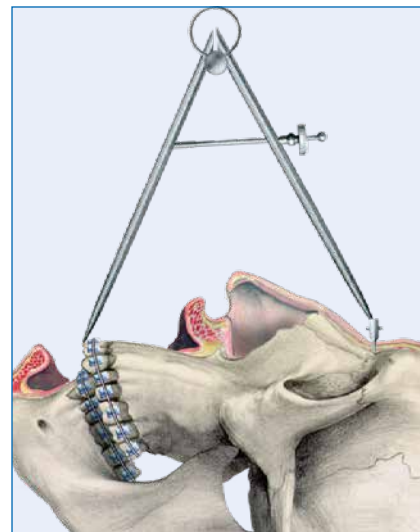

Verpackungseinheit "X" Stück
 Packing unit "X" pieces
 Paquete de "X" unidades
 Emballage de "X" pièces
 Confezione da "X" pezzi

**B08**

Mikro-Sägen mit Silikongriff
Micro Saws with Silicone Handle
Micro sierras con mango de silicona
Micro scies avec poignée en silicone
Micro seghe con impugnatura in silicone

Oszillierende Mikro-Säge mit Gabelschlüssel
 Micro oscillating saw with fork wrench
 Micro sierra oscilante con llave horquilla
 Micro scie oscillante avec clé
 Micro sega oscillante con chiave a forcina

Zubehör
 Accessories
 Accesorios
 Accessoires
 Accessori

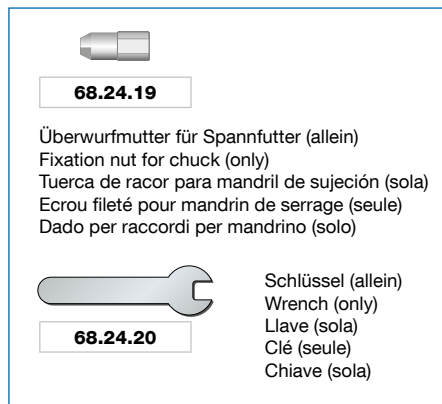
**Sachse**

15.000 U/min

12,5 cm - 5"
68.24.01



ohne Sägeblätter
 without saw blades
 sin hojas de sierra
 sans lames de scie
 senza lame da sega

Sägeblätter
 Saw blades
 Hojas de sierra
 Lames de scie
 Lame da sega

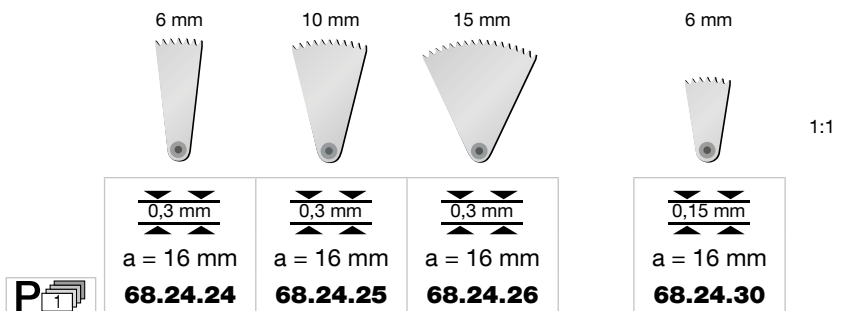

Nutzlänge
 Working length
 Largo útil
 Longueur utile
 Lunghezza utile

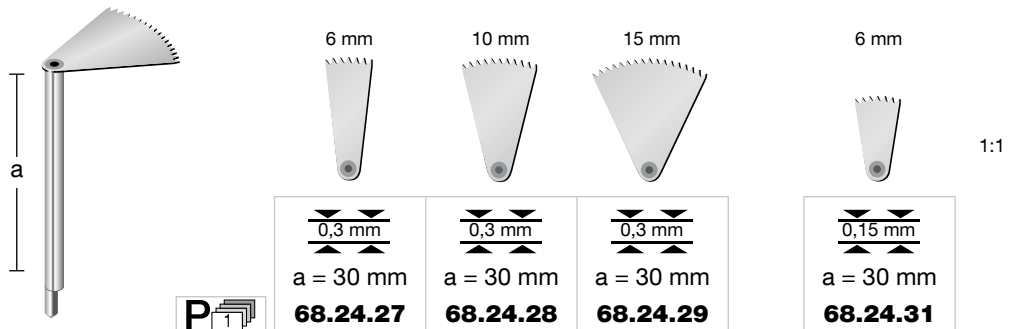

Maximale Motordrehzahl = Oszillationen/Minute
 Maximum speed = oscillations/minute
 Revoluciones máximas del motor = oscilaciones/minuto
 Nombre de tours maximum = oscillations/minute
 Massimo numero di giri del motore = oscillazioni/minuto



Spülrohr, integriert
 Irrigation tube, integrated
 Tubo de irrigación, integrado
 Canule de lavage, intégrée
 Tubo di lavaggio, integrato





Mikro-Sägen mit Silikongriff
Micro Saws with Silicone Handle
Micro sierras con mango de silicona
Micro scies avec poignée en silicone
Micro seghe con impugnatura in silicone

B08

Mikro-Sagittal-Säge mit Gabelschlüssel
 Micro sagittal saw with fork wrench
 Micro sierra sagital con llave horquilla
 Micro scie sagittale avec clé
 Micro sega sagittale con chiave a forcina

Zubehör
 Accessories
 Accesorios
 Accessoires
 Accessori

	68.24.19	Überwurfmutter für Spannfutter (allein) Fixation nut for chuck (only) Tuerca de racor para mandril de sujeción (sola) Ecrou fileté pour mandrin de serrage (seule) Dado per raccordi per mandrino (solo)
	68.24.20	Schlüssel (allein) Wrench (only) Llave (sola) Clé (seule) Chiave (sola)

















Sachse

 20.000 U/min
12,5 cm - 5"
68.24.03

ohne Sägeblätter
 without saw blades
 sin hojas de sierra
 sans lames de scie
 senza lame da sega

Sägeblätter
 Saw blades
 Hojas de sierra
 Lames de scie
 Lame da sega

	4 mm	6 mm	6 mm	10 mm	12 mm	6 mm
						
1:1						
	68.24.70	68.24.71	68.24.72	68.24.73	68.24.74	68.24.75

 Blattstärke
 Thickness of blade
 Grosor de la hoja
 Epaisseur de la lame
 Spessore della lama

 Verpackungseinheit "X" Stück
 Packing unit "X" pieces
 Paquete de "X" unidades
 Emballage de "X" pièces
 Confezione da "X" pezzi

**B08**

Mikro-Sägen mit Silikongriff
Micro Saws with Silicone Handle
Micro sierras con mango de silicona
Micro scies avec poignée en silicone
Micro seghe con impugnatura in silicone

Osseoskalpell mit Gabelschlüssel
 Osseoscalpel with fork wrench
 Osseoscalpel con llave horquilla
 Osséoscalpel avec clé
 Osseoscalpello con chiave a forcina

Zubehör
 Accessories
 Accesorios
 Accessoires
 Accessori

**68.24.19**

Überwurfmutter für Spannfutter (allein)
 Fixation nut for chuck (only)
 Tuerca de racor para mandril de sujeción (sola)
 Ecrou fileté pour mandrin de serrage (seule)
 Dado per raccordi per mandrino (solo)

**68.24.20**

Schlüssel (allein)
 Wrench (only)
 Llave (sola)
 Clé (seule)
 Chiave (sola)

**Sachse**

 20.000 U/min

12,5 cm - 5"

68.24.06

ohne Sägeblätter
 without saw blades
 sin hojas de sierra
 sans lames de scie
 senza lame da sega



Mikro-Säge mit axial/sagittalem Schnitt, Pendelhub, besonders geeignet für dreidimensionale Schnitfführungen
 Micro saw with axial/sagittal cut, oscillating hub, especially suitable for three dimensional cutting
 Micro sierra con corte axial/sagital, elevacion de pendulo, especialmente apropiada para cortes tridimensionales
 Micro scie à coupe axiale/sagittale, par voie excentrique, particulièrement conçue pour des coupes tridimensionnelles
 Micro sega con taglio assiale/saggitale, corsa del pendolo, adatto specialmente per guida tagli tredimensionali



Sägeblätter
 Saw blades
 Hojas de sierra
 Lames de scie
 Lame da sega



1:1

0,35 mm

a = 12 mm

68.24.35

0,35 mm

a = 18 mm

68.24.36

0,35 mm

a = 24 mm

68.24.37

Maximale Motordrehzahl = Oszillationen/Minute
 Maximum speed = oscillations/minute
 Revoluciones máximas del motor = oscilaciones/minuto
 Nombre de tours maximum = oscillations/minute
 Massimo numero di giri del motore = oscillazioni/minuto



Spülrohr, integriert
 Irrigation tube, integrated
 Tubo de irrigación, integrado
 Canule de lavage, intégrée
 Tubo di lavaggio, integrato

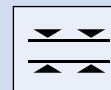



Blattstärke
 Thickness of blade
 Grosor de la hoja
 Epaisseur de la lame
 Spessore della lama

Mikro-Sägen mit Silikongriff
Micro Saws with Silicone Handle
Micro sierras con mango de silicona
Micro scies avec poignée en silicone
Micro seghe con impugnatura in silicone

B08

Mikro-Stichsäge mit Gabelschlüssel
 Micro compass saw with fork wrench
 Micro sierra de vaivén con llave horquilla
 Micro scie à guichet avec clé
 Micro sega con chiave a forcina

Zubehör
 Accessories
 Accessorios
 Accessoires
 Accessori

	68.24.19	Überwurfmutter für Spannfutter (allein) Fixation nut for chuck (only) Tuerca de racón para mandril de sujeción (sola) Ecrou fileté pour mandrin de serrage (seule) Dado per raccordi per mandrino (solo)
	68.24.20	Schlüssel (allein) Wrench (only) Llave (sola) Clé (seule) Chiave (sola)
	68.24.22	Ersatz-Spülrohr Spare irrigation tube Tubo para irrigación de recambio Canule de lavage de rechange Tubo di lavaggio di ricambio



 15.000 U/min

12,5 cm - 5"
68.24.11









ohne Sägeblätter
 without saw blades
 sin hojas de sierra
 sans lames de scie
 senza lame da sega

Raspelaufsatz
 Rasp
 Escofina
 Râpe
 Raspa

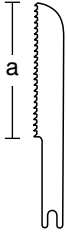

"HM" **68.24.21** 5,5 cm - 2 1/8"

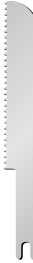
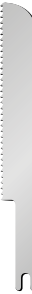
Sägeblätter
 Saw blades
 Hojas de sierra
 Lames de scie
 Lame da sega

					
	$\frac{0,25 \text{ mm}}$	$\frac{0,25 \text{ mm}}$	$\frac{0,25 \text{ mm}}$	$\frac{0,25 \text{ mm}}$	$\frac{0,25 \text{ mm}}$
	a = 11 mm	a = 14 mm	a = 18 mm	a = 22 mm	a = 26 mm
	68.24.12	68.24.13	68.24.14	68.24.15	68.24.16

1:1



Spülrohr, abnehmbar
 Irrigation tube, detachable
 Tubo de irrigación, desmontable
 Canule de lavage, démontable
 Tubo di lavaggio, smontabile

"HM"

Hartmetall
 Tungsten carbide
 Carburo de tungsteno
 Carbone de tungstène
 Carburo di tungsteno

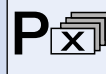

Verpackungseinheit "X" Stück
 Packing unit "X" pieces
 Paquete de "X" unidades
 Emballage de "X" pièces
 Confezione da "X" pezzi

**B08**

Mikro-Sägen mit Silikon Griff
Micro Saws with Silicone Handle
Micro sierras con mango de silicona
Micro scies avec poignée en silicone
Micro seghe con impugnatura in silicone

Indikationsbereiche
 Fields of applications
 Campos de indicación
 Secteurs d'application
 Campi di applicazione



		68.24.01	68.24.03	68.24.06	68.24.11
Kraniofaziale Chirurgie Craniofacial Surgery Cirugia craneofacial Chirurgie cranio-faciale Chirurgia craniofacciale	Entnahme von Kalotten-Transplantaten Harvesting of cranial bone grafts Extracción de trasplantes de calota Prélèvement de transplants de la calotte Prelievo di innesti della calotta	○	☆	★	☆
	Osteotomie des Frontal Bandeau einschließlich Orbitotomie Osteotomy of the frontal bandeau including orbitotomy Osteotomía de la banda frontal incluido orbitotomía Ostéotomie du bandeau frontal avec orbitotomie Osteotomia della fascia frontale incluso orbitotomia	○	☆	★	☆
	Osteotomie und Konturierung der Kalottensegmente Osteotomy and contouring of cranial segments Osteotomía y contorneado de los segmentos de la calota Ostéotomie et contours des segments de la calotte Osteotomia e contornitura dei segmenti di calotta	☆	★	☆	○
	Osteotomie im Nasoethmoidalkomplex Osteotomy within the nasal ethmoidal complex Osteotomía en el complejo nasoethmoidal Ostéotomie dans le complexe nasoéthmoïdal Osteotomia nel complesso nasoetmoidale	—	☆	☆	☆
		68.24.01	68.24.03	68.24.06	68.24.11
Maxillofaziale Chirurgie Maxillofacial Surgery Cirugia maxilofacial Chirurgie maxillo-faciale Chirurgia maxillofacciale	Interdentale Osteotomie Interdental osteotomy Osteotomía interdental Ostéotomie interdendale Osteotomia interdendale	☆	☆	☆	☆
	Transversale Orbitotomie Transversal orbitotomy Orbitotomía transversal Orbitotomie trasversale Orbitotomia trasversale	★	○	○	○
	Osteotomie der fazialen Unterkieferwand nach Abello oder Lindorf Osteotomy of the facial mandibular wall acc. to Abello or Lindorf Osteotomía de la pared mandibular facial según Abello o Lindorf Ostéotomie de la paroi du maxillaire inférieure faciale selon Abello ou Lindorf Osteotomia della parete mandibolare facciale secondo Abello o Lindorf	★	☆	☆	☆
	Vertikale Osteotomie des aufsteigenden Unterkiefers von intraoral Vertical osteotomies of the ascending ramus from intraoral Osteotomías verticales del maxilar inferior ascendente desde intraoral Ostéotomies verticales du maxillaire inférieur montant, en intra-oral Osteotomo verticale della mandibola ascendente intraorale	★	—	—	—
	Laterale Segmentosteotomien Lateral segment osteotomies Ostectomías de segmentos laterales Ostéotomies des segments latéraux Osteotomie di segmenti laterali	★	☆	☆	☆
	Anteriore Segmentosteotomien Anterior segment osteotomies Osteotomías de segmentos anteriores Ostéotomies des segments antérieurs Osteotomie di segmenti anteriori	☆	☆	★	★



sehr gut geeignet
 absolutely suitable
 especialmente apto
 très approprié
 perfettamente appropriato



gut geeignet
 very suitable
 muy apto
 bien approprié
 molto appropriato



Mikro-Sägen mit Silikon Griff
Micro Saws with Silicone Handle
Micro sierras con mango de silicona
Micro scies avec poignée en silicone
Micro seghe con impugnatura in silicone

B08

Indikationsbereiche
 Fields of application
 Campos de indicación
 Secteurs d'application
 Campi di applicazione



		68.24.01	68.24.03	68.24.06	68.24.11
Maxillofaziale Chirurgie Maxillofacial Surgery Cirugía maxilo-facial Chirurgie maxillo-faciale Chirurgia maxillo-facciale	Osteotomien der Le Fort Ebenen Le Fort osteotomies Osteotomías de los planos de Le Fort Ostéotomies des plans de Le Fort Osteotomie dei piani di Le Fort	—	☆	☆	☆
	Osteotomien des Unterkiefers inklusive sagittale Spaltung Mandibular osteotomies incl. sagittal split Osteotomías del maxilar inferior inclusive escisión sagital Ostéotomies du maxillaire inférieur avec fission sagitale Osteotomia della mandibola compreso l'osteotomia saggitale	—	○	★	○
	Kinnosteotomien Chin osteotomies Osteotomías de mentón Ostéotomies du menton Osteotomie del mento	○	○	★	☆
	Tumorresektionstherapie Tumor resection therapy Terapia de resección de tumores Thérapie par résection tumorale Terapia di resezione dei tumori	○	☆	★	☆
	Osteotomie der Scapula, des Beckenkammes und der Fibula im Rahmen der Rekonstruktionstherapie Osteotomy of scapula, iliac crest and fibula within reconstruction therapy Osteotomía de la escápula, de la cresta ilíaca y del peroné en el marco de la terapia reconstructiva Ostéotomie de l'omoplate, du bassin et du péroné, dans le cadre de la thérapie reconstructive Osteotomia della scapola, della cresta iliaca e del perone nell'ambito della terapia ricostruttiva	○	☆	☆	☆
Handchirurgie Hand Surgery Cirugía de la mano Chirurgie de la main Chirurgia della mano	Osteotomie der Phalangen Mittelhandknochen, Radius und Ulna Osteotomy of phalanxes, metacarpal bones, radius and ulna Osteotomía de las falanges del metacarpiano, radio y cúbito Ostéotomie des phalanges, des os métacarpiens, du radius et du cubitus Osteotomia delle falangi, delle ossa metacarpiche, del radio e dell'ulna	○	☆	★	☆
	Knochentransplantatentnahme vom Beckenkamm, Radius Bone graft harvesting from the iliac crest and the radius Extracción de trasplantes óseos de la cresta ilíaca, radio Prélèvement de transplants osseux du bassin, du radius Prelievo di innesti ossei dalla cresta iliaca e del radio	○	☆	★	○

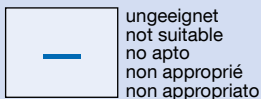
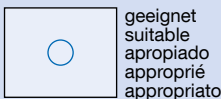



B09

Drähte und Drahtinstrumente
Wires and Wire Instruments
Alambre e instrumentos para alambre
Fils et instruments pour fils métalliques
Fili e strumenti per fili d'acciaio



12,5 cm – 5"
68.04.73

Drahtdrehklemme
 Wire twister
 Pinza para torcer alambre
 Pince à torsader le fil
 Pinza per torcere fili

Obwegeser "HM"

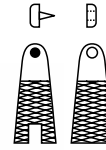

15,5 cm – 6 1/8"
68.04.76

Drahtösenklemme
 Wire loop forceps
 Pinza para aros de alambre
 Pince pour œillets en fil métallique
 Pinza per occhiello in filo metallico

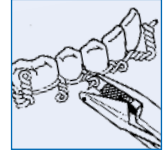

Obwegeser



15 cm – 6"
68.15.50

Drahtpositionierer
 Wire pusher
 Instrumento para posicionar alambre
 Positionneur de fil
 Posizionatore per filo

Mershon

"HM"

Hartmetall
 Tungsten carbide
 Carburo de tungsteno
 Carbure de tungstène
 Carburo di tungsteno

Drähte und Drahtinstrumente
Wires and Wire Instruments
Alambre y instrumentos para alambre
Fils et instruments pour fils métalliques
Fili e strumenti per fili d'acciaio

B09

Drahtbogen
 Arch bar
 Arco de alambre
 Arc en fil
 Arco di filo



Erich 14 cm – 5½" **68.15.10** P₁₂

Drahtbügelschiene
 Arch bar
 Arco de alambre
 Arc en fil
 Arco di filo



Dautrey 15 cm – 6" **68.04.93** P₁

Drahtbogen
 Arch bar
 Arco de alambre
 Arc en fil
 Arco di filo



Erich 68.15.05 1 m

Knochendrähte, weich
 Bone wires, soft
 Alambre para huesos, dulce
 Fils à os, souple
 Fili per ossa, dolce



10 m	76.01.03	● Ø 0,3 mm	(29 G)
10 m	76.01.04	● Ø 0,4 mm	(27 G)
10 m	76.01.05	● Ø 0,5 mm	(25 G)



Drahtstärke
 Thickness of wire
 Grosor del alambre
 Epaisseur du fil
 Spessore del filo

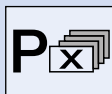

Verpackungseinheit "X" Stück
 Packing unit "X" pieces
 Paquete de "X" unidades
 Emballage de "X" pièces
 Confezione da "X" pezzi



**Koriotom
Coriotome
Coriotomo
Choriotome
Coriotomo**

B10



65 mm

19 cm - 7½"
67.14.15

Kasten

Zur Präparation von Vollhauttransplantaten
For the preparation of full thickness skin grafts
Para la preparación de injertos de piel entera
Pour la préparation de greffes de peau entière
Per la preparazione di innesti della pelle intera



**Neue Präparationsmethode
New method of preparation
Nuevo método de preparación
La nouvelle méthode de préparation
Nuovo metodo di preparazione**

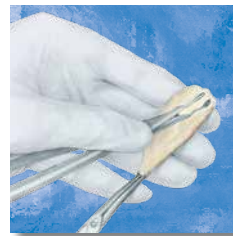

Konventionelle Präparationsmethode
Conventional method of preparation
Método de preparación convencional
Méthode de préparation conventionnelle
Metodo di preparazione convenzionale

Präparationsplatte
Preparation plate
Base de preparación
Plateau de préparation
Lastra di preparazione



200 x 130 x 11 mm **67.14.20**

Ersatzklinge
Spare blade
Hoja de repuesto
Lame de rechange
Lama di ricambio



1:1

6,5 cm - 2½" **67.14.25** **P**₁₀



Verpackungseinheit "X" Stück
Packing unit "X" pieces
Paquete de "X" unidades
Emballage de "X" pièces
Confezione da "X" pezzi



				
Humby	32 cm - 12½"	67.14.30	0,1 - 1,2 mm	155 mm (max.)



				
Watson	30,5 cm - 12"	67.14.35	0,1 - 2,0 mm	155 mm (max.)

Ersatzklinge
 Spare blade
 Hoja de repuesto
 Lame de rechange
 Lama di ricambio



15,5 cm - 6¼"	67.14.31
---------------	-----------------

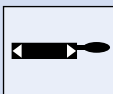

Schnittbreite
 Width of cut
 Ancho del corte
 Largeur de la coupe
 Larghezza del taglio

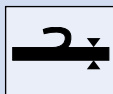

Schnittstärke
 Thickness of cut
 Grosor del corte
 Epaisseur de la coupe
 Spessore del taglio

**B10**

Dermatome, Zubehör
Dermatome, Accessories
Dermatomo, Accesorios
Dermatome, Accessoires
Dermatomo, Accessori

Dermatom mit 2 Spannplatten
 Dermatome with 2 stretching plates
 Dermatomo con 2 placas tensoras
 Dermatome avec 2 plaques à tendre
 Dermatomo con 2 piastra per tendere



Schink	30 cm - 11¾"	67.14.50	0,1 - 2,0 mm	100 mm (max.)

Haut-Spannplatte
 Skin stretching plate
 Placa tensora de membrana
 Plaque pour tendre la peau
 Piastra per tendere la pelle

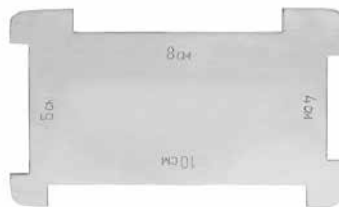

13 × 7,5 cm
67.14.52

Ersatzklinge
 Spare blade
 Hoja de repuesto
 Lame de rechange
 Lama di ricambio



10 cm - 4"
67.14.51



Silver	19 cm - 7½"	78.05.00	0,1 - 1,2 mm	40 mm (max.)

Ersatzklinge
 Spare blade
 Hoja de repuesto
 Lame de rechange
 Lama di ricambio



P₁₀
01.94.19



Schnittbreite
 Width of cut
 Ancho del corte
 Largeur de la coupe
 Larghezza del taglio

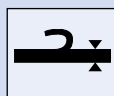

Schnittstärke
 Thickness of cut
 Grosor del corte
 Epaisseur de la coupe
 Spessore del taglio

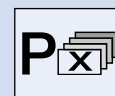

Verpackungseinheit "X" Stück
 Packing unit "X" pieces
 Paquete de "X" unidades
 Emballage de "X" pièces
 Confezione da "X" pezzi



Rhinoplastik
Rinoplastic
Rinoplastica
Rhinoplastie
Rinoplastica

C

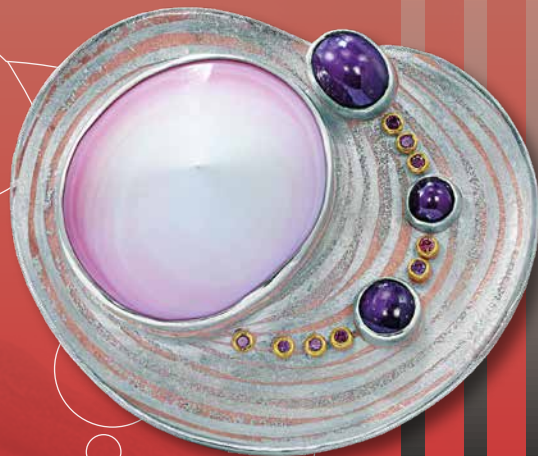

Z O B E L



C01

Rhinoplastikscheren
Rhinoplasty Scissors
Tijeras para rinoplastia
Ciseaux pour rinoplastie
Forbici per rinoplastica



Heymann

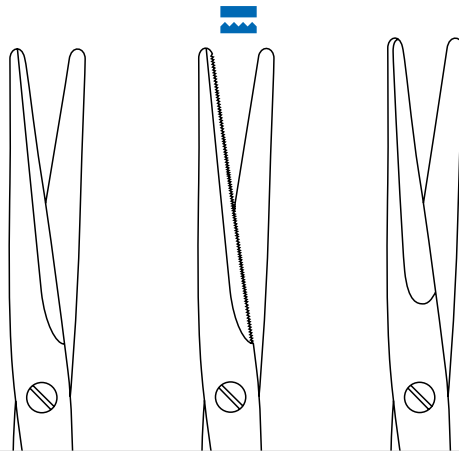

17 cm - 6¾"	17 cm - 6¾"	18 cm - 7⅛"	
66.40.20	66.40.21		standard
		266.40.21	supercut



Converse-Daniel

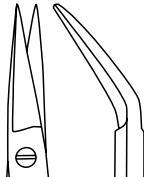

9,5 cm - 3¾"	
277.53.90	black line



Heymann



20 cm - 8"	
66.40.22	standard



Eine Schneide gezahnt
 One blade serrated
 Una hoja dentada
 Une lame dentelée
 Una lama dentellata

Rhinoplastikscheren
Rhinoplasty Scissors
Tijeras para rinoplastia
Ciseaux pour rhinoplastie
Forbici per rinoplastica

C01

Fadenführungsschere
 Suture carrying scissors
 Tijera guía-hilo
 Ciseaux guide-fil
 Forbice guida filo



Cottle-Masing

10 cm - 4"	10 cm - 4"	
67.48.10	67.49.10	standard



Littler

12 cm - 4¾"	
67.50.01	standard



Cottle

11,5 cm - 4½"	
67.50.11	standard

Bulldogschere
 Bulldog scissors
 Tijera Bulldog
 Ciseaux Bulldog
 Forbice Bulldog



Converse

13,5 cm - 5⅜"	
67.50.13	standard



Cinelli

11 cm - 4⅜"	
67.52.11	standard



Außenkanten halbscharf
 Outer edges semisharp
 Bords extérieurs semicortantes
 Bords extérieurs semi-tranchants
 Bordi esterni semitaglienti

**C01**

Rhinoplastikscheren
Rhinoplasty Scissors
Tijeras para rinoplastia
Ciseaux pour rhinoplastie
Forbici per rinoplastica

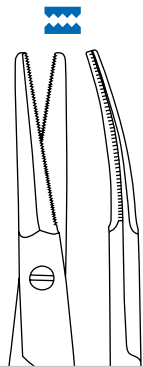
**Fomon**

12,5 cm - 5"

67.51.12

standard

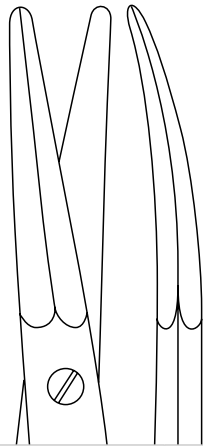
**Aufricht**

14 cm - 5½"

67.51.14

standard

267.51.14

supercut

277.51.14

black line

67.51.64

"HM"

267.51.64

supercut plus

mit Außenschliff, beidseitig schneidend
 with outer cutting, both sides sharp
 con afilado exterior, cortantes por ambos lados
 avec affûtage extérieur, coupants des deux côtés
 con affilatura esterna, tagliente da ambedue i lati

Knorpelschere
 Cartilage scissors
 Tijera para cartílagos
 Ciseaux à cartilages
 Forbice per cartilagine

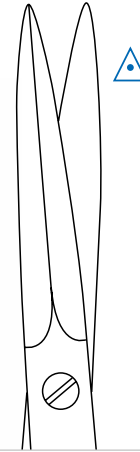
**McIndoe**

19 cm - 7½"

67.51.19

standard

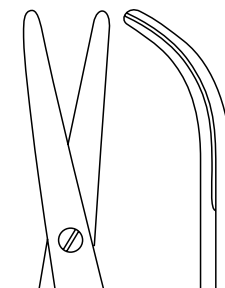
**Fomon**

12 cm - 4¾"

67.52.12

standard

267.52.12

supercut

277.52.12

black line



Gezahnte Schneiden
 Serrated cutting edges
 Hojas dentadas
 Lames dentelées
 Lame dentellate



Außenkanten halbscharf
 Outer edges semisharp
 Bordes exteriores semicortantes
 Bords extérieurs semi-tranchants
 Bordi esterni semitaglienti

Rhinoplastikscheren
Rhinoplasty Scissors
Tijeras para rinoplastia
Ciseaux pour rhinoplastie
Forbici per rinoplastica

C01

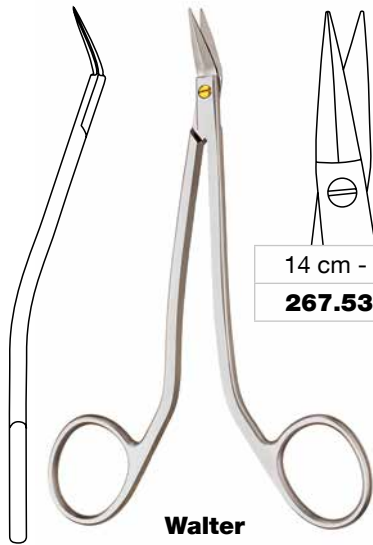

14 cm - 5½"	
267.53.14	supercut

Walter

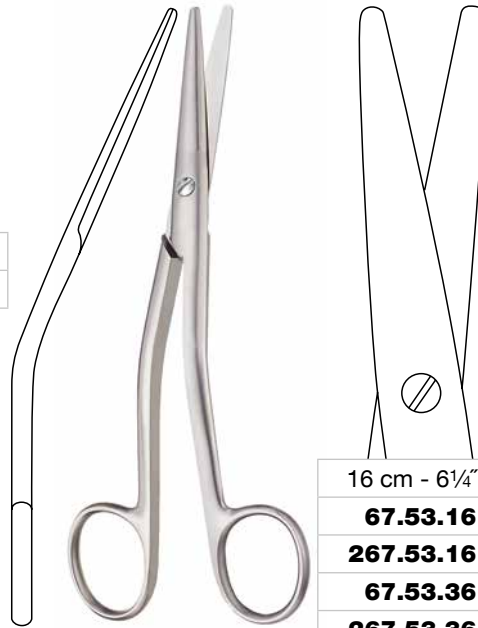

16 cm - 6¼"	
67.53.16	standard
267.53.16	supercut
67.53.36	"HM"
267.53.36	supercut plus
227.53.36	magic cut

Cottle

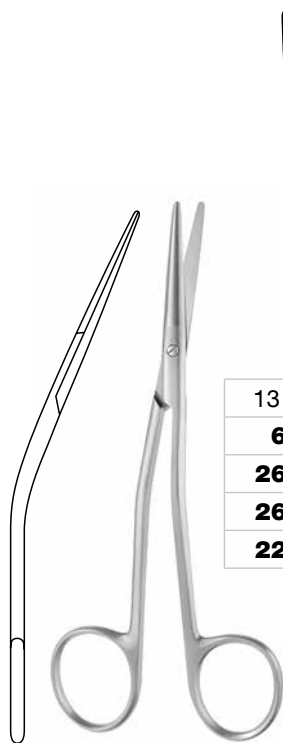

13 cm - 5⅛"	
67.53.13	standard
267.53.13	supercut
267.53.63	supercut plus
227.53.63	magic cut

Fomon

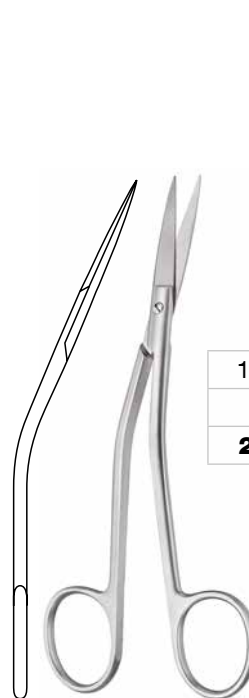

14 cm - 5½"	
67.53.23	standard
267.53.23	supercut

Fanous



C01

Rhinoplastikscheren
Rhinoplasty Scissors
Tijeras para rinoplastia
Ciseaux pour rhinoplastie
Forbici per rinoplastica

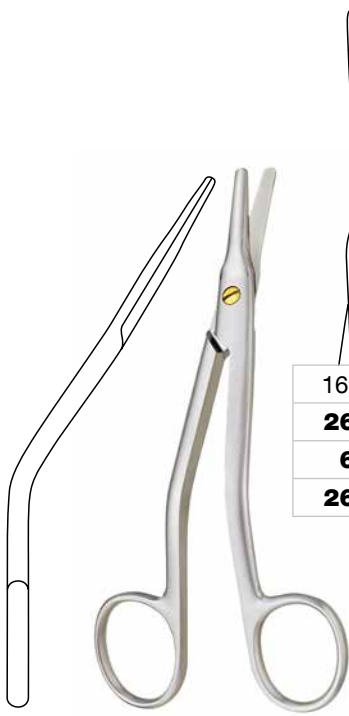

Walter-Cottle

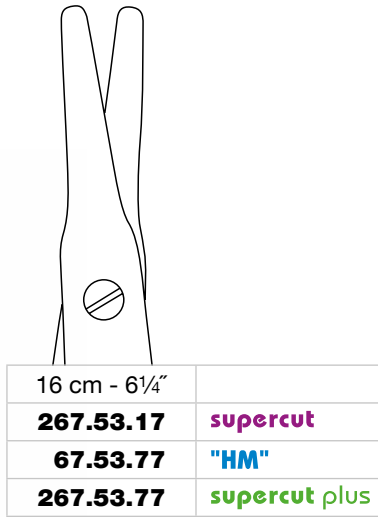

16 cm - 6¼"	
267.53.17	supercut
67.53.77	"HM"
267.53.77	supercut plus



Giunta

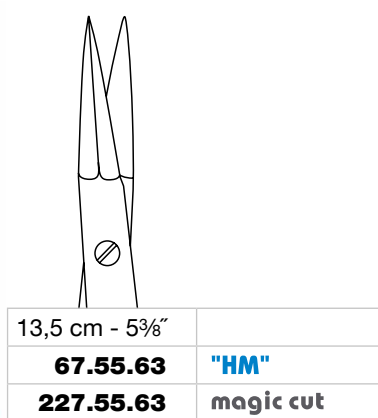

13,5 cm - 5⅜"	
67.55.63	"HM"
227.55.63	magic cut

Nasenseptumschere
Nasal septum scissors
Tijera para el tabique nasal
Ciseaux pour cloison nasale
Forbice per setto nasale



Caplan

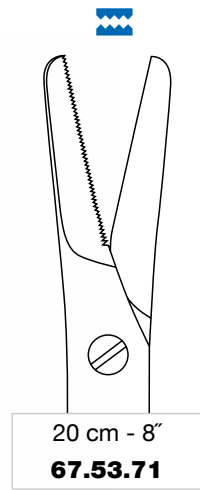

20 cm - 8"	
67.53.71	



Gezante Schneiden
Serrated cutting edges
Hojas dentadas
Lames dentelées
Lame dentellate

Rhinoplastikscheren
Rhinoplasty Scissors
Tijeras para rinoplastia
Ciseaux pour rhinoplastie
Forbici per rinoplastica

C01

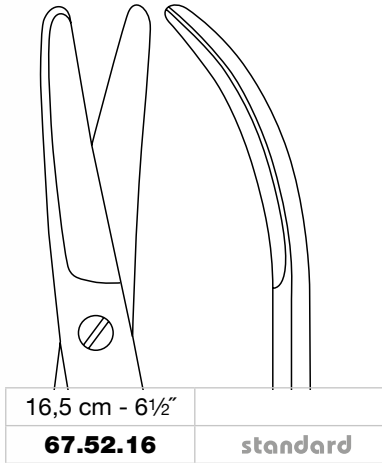

Joseph

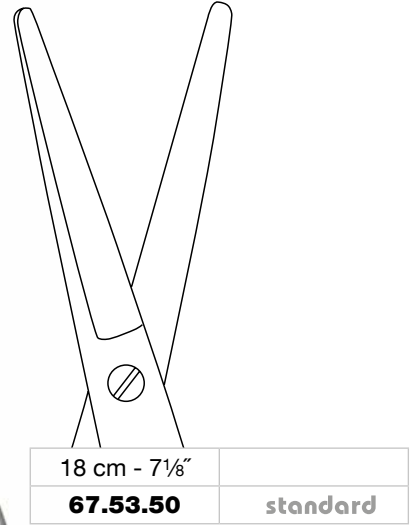

Cottle

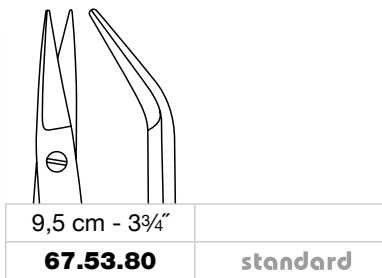

Winter

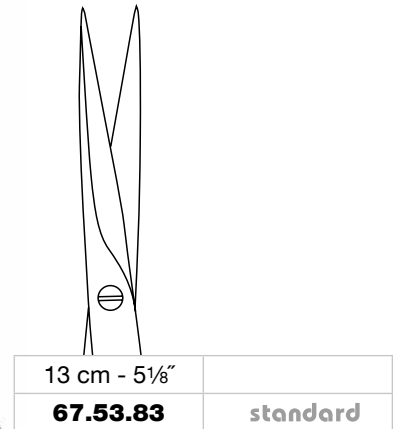
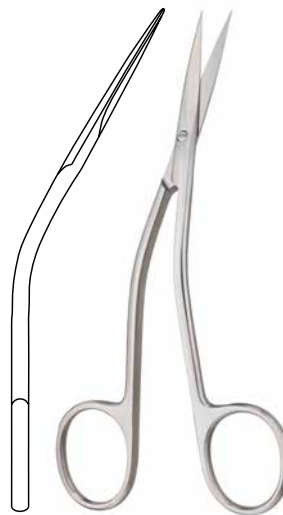

Hough



C01

Rhinoplastikscheren
Rhinoplasty Scissors
Tijeras para rinoplastia
Ciseaux pour rhinoplastie
Forbici per rinoplastica

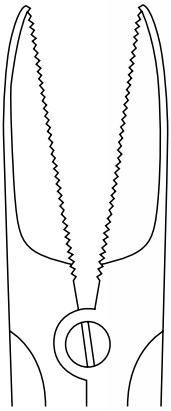

Obwegeser

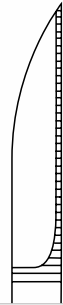

21 cm - 8 1/4"
67.65.31

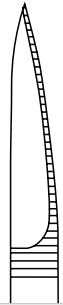

21 cm - 8 1/4"
67.65.32

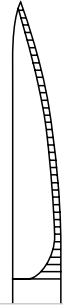

21 cm - 8 1/4"
67.65.33



Nasentrückenscheren
Nasal ridge scissors
Tijeras para dorso nasal
Ciseaux pour le dos nasal
Forbici per dorso nasale

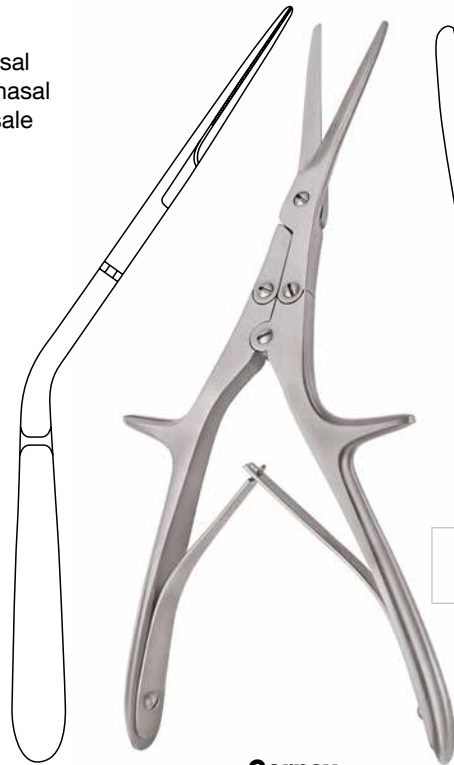
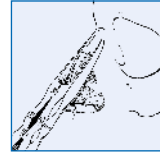

Gorney

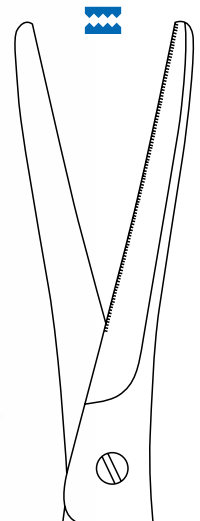

20 cm - 8"
67.53.75

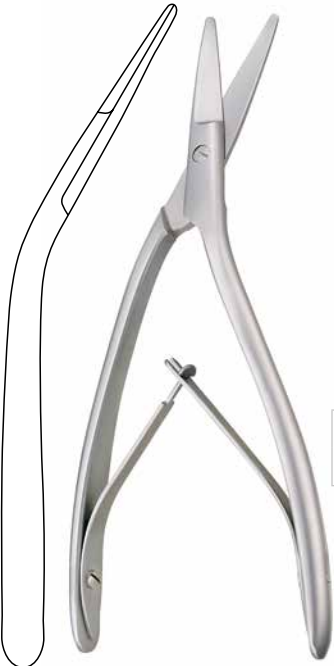

Cottle

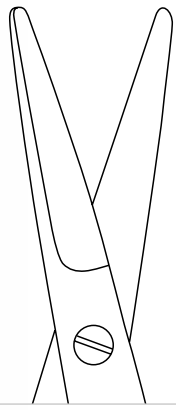

18 cm - 7 1/8"
67.53.51

Nasenseptumschere
Nasal septum scissors
Tijera para el tabique nasal
Ciseaux pour cloison nasale
Forbice per setto nasale



Gezähnte Schneiden
Serrated cutting edges
Hojas dentadas
Lames dentelées
Lame dentellate



Besonders geeignet bei der offenen Rhinoplastik für die sehr empfindliche Lappenspitze.

Particularly suitable for open rhinoplasty on the highly sensitive flap end.

Especialmente adecuado para la rinoplastia abierta de la punta muy sensible del lóbulo.

Convient en particulier pour la rhinoplastie ouverte de la pointe lobaire très sensible.

Particolarmente adatto per gli interventi aperti di rinoplastica alla punta del lobo molto sensibile.



16 cm - 6¼"
20.50.01

Joseph

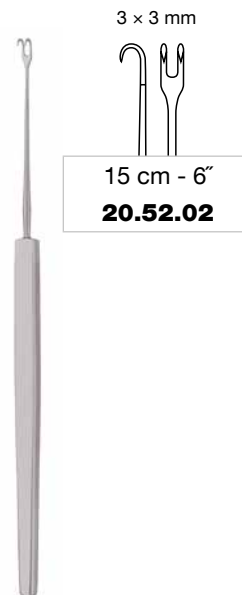

15 cm - 6"
20.52.02

Freer





C03

Feine Wundhaken
Delicate Retractors
Separadores finos
Ecarteurs fins
Divaricatori delicati





5 mm 2 mm 5 mm

17 cm - 6³/₄" 17 cm - 6³/₄"

20.50.02 **20.50.05**

7 mm 10 mm

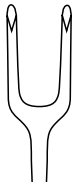

17 cm - 6³/₄" 17 cm - 6³/₄"

20.50.07 **20.50.10**

Joseph

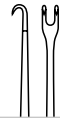

1,5 x 2 mm 2 x 3 mm



13 cm - 5¹/₈" 13 cm - 5¹/₈"

20.52.10 **20.52.11**

Guthrie



20 x 8 mm

11 cm - 4³/₈"

20.09.30

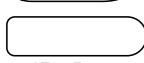

17 x 5 mm

Crile

Pfriem
 Awl
 Punzón
 Poinçon
 Punteruolo

16 cm - 6¹/₄"

67.16.70

Daniel



Wundhakenblatt, gewölbt
 Retractor blade, curved
 Hoja de separador, abovedada
 Lame d'écarteur, courbée
 Valva convessa

**Nasenspekula
Nasal Specula
Espéculos nasales
Spéculums nasaux
Specoli nasali**

C04



Hartmann

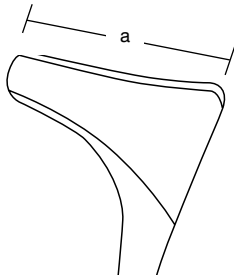

	15 cm - 6"
a = 26 mm, # 1	66.02.01
a = 30 mm, # 2	66.02.02
a = 32 mm, # 3	66.02.03



Mod. Wien

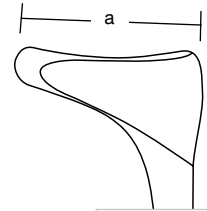

	14 cm - 5½"
a = 24 mm, # 1	66.05.51
a = 30 mm, # 2	66.05.52
a = 32 mm, # 3	66.05.53



Tieck-Halle



13 cm - 5½"
66.01.10

für Säuglinge
for babies
para lactantes
pour nourrissons
per neonati

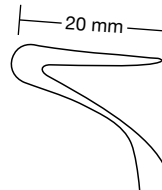

13,5 cm - 5¾"
66.01.11

für Kleinkinder
for infants
para niños pequeños
pour petits enfants
per bambini piccoli



C04

Nasenspekula
Nasal Specula
Espéculos nasales
Spéculums nasaux
Specoli nasali



14 cm - 5½"
66.08.59

Killian

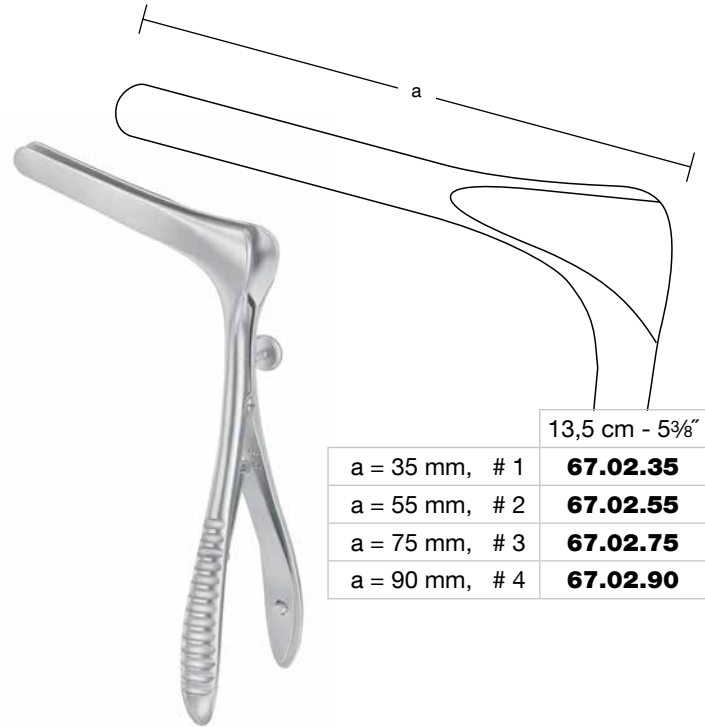

13,5 cm - 5⅜"

a = 35 mm, # 1	67.02.35
a = 55 mm, # 2	67.02.55
a = 75 mm, # 3	67.02.75
a = 90 mm, # 4	67.02.90

Cottle



13,5 cm - 5⅜"

a = 35 mm, # 1	66.08.03
a = 50 mm, # 2	66.08.05
a = 75 mm, # 3	66.08.07
a = 90 mm, # 4	66.08.09

Killian

Nasenseptumspekulum
 Nasal septum speculum
 Espéculo para el septo nasal
 Spéculum pour la cloison nasale
 Specolo per il setto nasale



Cottle



Cottle

Columella-Klemme
 Columella forceps
 Pinza para columela
 Pince pour columelle
 Pinza per columella



Cottle



C05

Nasenraspeln
Nasal Rasps
Raspadores nasales
Râpes nasales
Raspe nasali



Knorpelschaber
 Cartilage abraders
 Rascadores de cartilago
 Grattoirs à cartilages
 Raschiatori per cartilagine

67.59.10
 Set komplett (#1+2)
 Set complete (#1+2)
 Juego completo (#1+2)
 Jeu complet (#1+2)
 Set completo (#1+2)

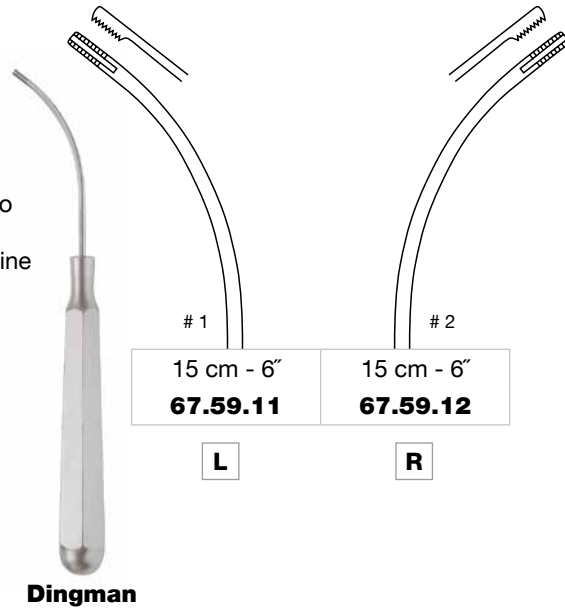

1 # 2

15 cm - 6" 15 cm - 6"

67.59.11 **67.59.12**

L **R**

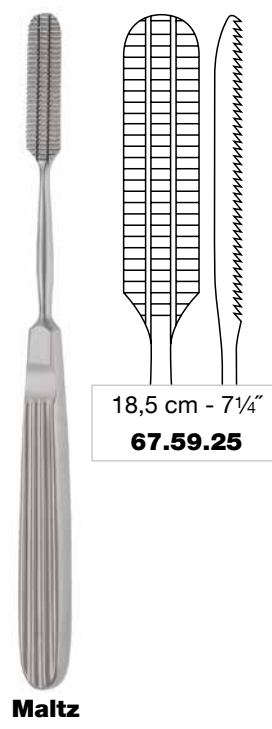

18,5 cm - 7 1/4"

67.59.25

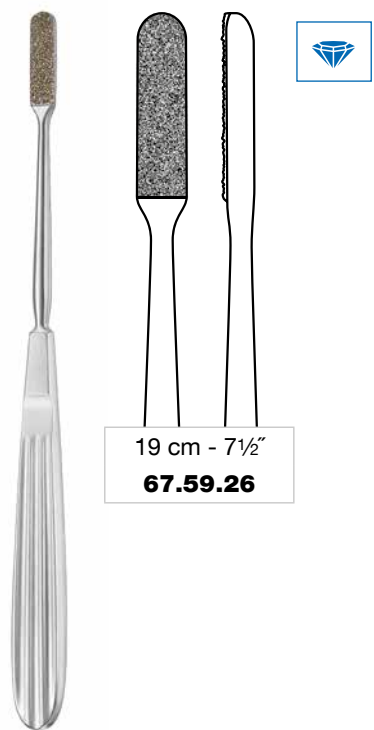

19 cm - 7 1/2"

67.59.26

L
 links
 left
 izquierdo
 gauche
 sinistro

R
 rechts
 right
 derecho
 droite
 destro

 Beschichtung mit Diamantstaub
 Coating with diamond dust
 Recubierto con polvo de diamante
 Revêtement avec de poussière de diamant
 Rivestito con polvere di diamante



Lewis

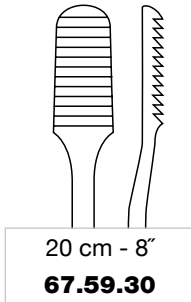

20 cm - 8"
67.59.30



Cottle

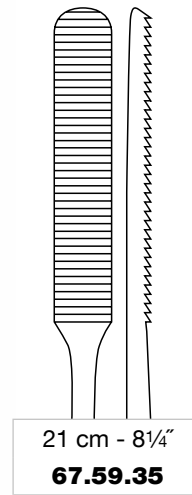

21 cm - 8¼"
67.59.35



Cottle "HM"

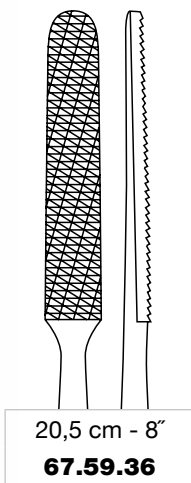

20,5 cm - 8"
67.59.36

"HM"
 Hartmetall
 Tungsten carbide
 Carburo de tungsteno
 Carbure de tungstène
 Carburo di tungsteno



C05

Nasenraspeln
Nasal Rasps
Raspadores nasales
Râpes nasales
Raspe nasali



19,5 cm - 7¾"
67.59.47



Lewis "HM"

19,5 cm - 7¾"
67.59.50



Aufricht

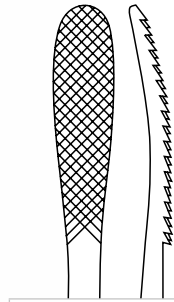

21 cm - 8¼"
67.59.40

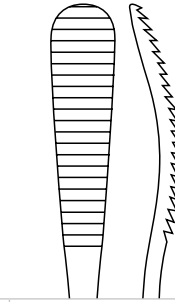

21 cm - 8¼"
67.59.41

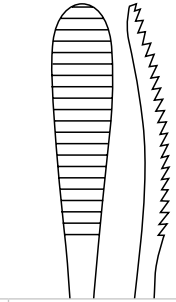

21 cm - 8¼"
67.59.42

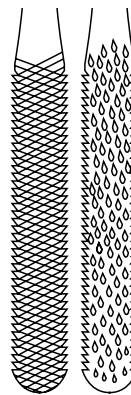

Fomon



22 cm - 8¾"
67.59.60

"HM"
Hartmetall
Tungsten carbide
Carburo de tungsteno
Carbure de tungstène
Carburo di tungsteno

Nasenraspeln
Nasal Rasps
Raspadores nasales
Râpes nasales
Raspe nasali

C05

fein
 fine
 fino
 fin
 fina

halbfein
 semi fine
 semifino
 semifin
 semifina

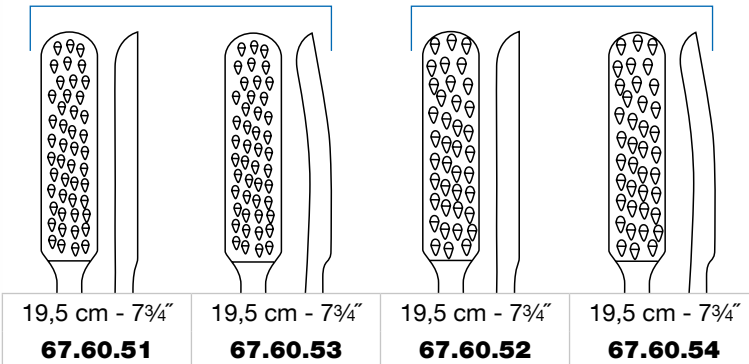

Jeweils ein Arbeitsende der Raspeln arbeitet auf Schub, das andere auf Zug.

One working end of the rasp operates by pushing, the other by pulling.

Una parte de las rasps trabaja a empuje, la otra parte a tracción.

Un bout des râpes coupe en poussant, l'autre en tirant.

Una parte lavorativa della raspa funziona da spinta e l'altra da trazione.



Obwegeser

fein
 fine
 fino
 fin
 fina

halbfein
 semi fine
 semifino
 semifin
 semifina

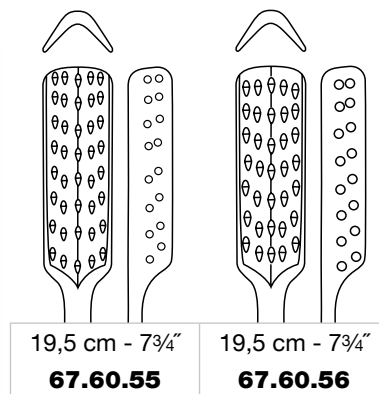

Die Knochenspäne werden durch die Perforationen nach außen abgedrängt, wodurch die Raspeln nicht verstopfen und einfacher zu reinigen sind.

Bone splinters are pushed through the perforated working ends. This avoids plugging of the rasps and they can be cleaned easily.

Las raspaduras de huesos son apartadas por las perforaciones hacia fuera; así no se atascan los raspadores y pueden ser limpiados más fácil.

Les copeaux d'os sont poussés vers l'extérieur à travers les perforations. Ceci évite un bouchage et facilite un meilleur nettoyage.

I trucioli delle ossa vengono eliminati fuori dalla perforazione poichè le raspe non si otturano e sono facilmente pulibili.



Obwegeser





C05

Nasenraspeln
Nasal Rasps
Raspadores nasales
Râpes nasales
Raspe nasali

“X-CHANGE” NASAL RASPS



Die sehr flachen Raspelblätter sind einzeln ersetzbar und gewährleisten auf effiziente Weise immer ein scharfes Instrument.

The very flat, individually replaceable rasp blades are an efficient way of always ensuring a sharp instrument.

Las hojas de la raspa muy planas pueden ser utilizadas por separado y garantizan de forma eficaz que uno dispone siempre de un instrumento adecuadamente afilado.

Les lames de râpes sont interchangeables et disponibles à l'unité. Ce qui assure à l'instrument un parfait tranchant.

Gli inserti di raspa molto fine sono sostituibili singolarmente e garantiscono in modo efficace uno strumento sempre tagliente.

Handgriffe
Handles
Mangos
Manches
Manici



14 cm – 5½”
67.61.00

15 cm – 6”
67.61.01

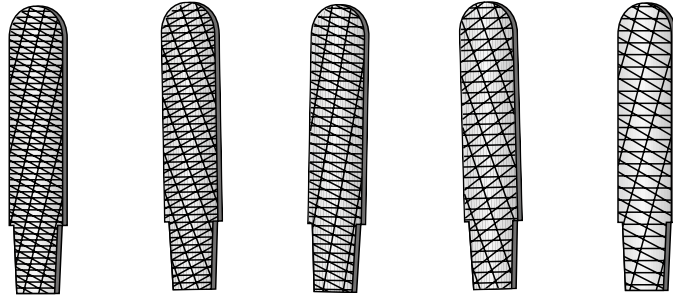

“HM”	# 1	# 2	# 3	# 4	# 5
	67.61.10	67.61.11	67.61.12	67.61.13	67.61.14

1:1

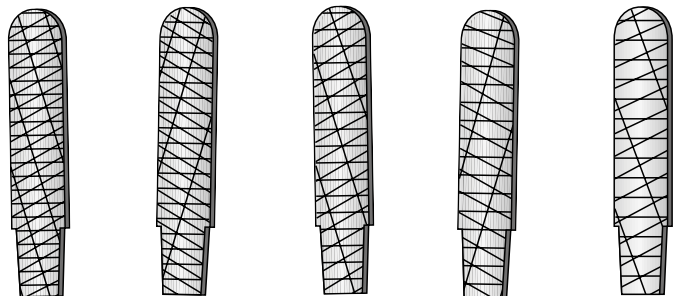

“HM”	# 6	# 7	# 8	# 9	# 10
	67.61.15	67.61.16	67.61.17	67.61.18	67.61.19

1:1



Schlüssel
Wrench
Llave
Clé
Chiave



67.61.03

“HM”

Hartmetall
Tungsten carbide
Carburo de tungsteno
Carbure de tungstène
Carburo di tungsteno



Nasenraspeln und -feilen
Nasal Rasps and Files
Raspadores y limas nasales
Râpes et limes nasales
Raspe e lime nasali

C05

Nasenfeile
 Nasal file
 Lima nasal
 Lime nasale
 Lima nasale



18,5 cm - 7¼"
67.59.65

Converse

Nasenraspel
 Nasal rasp
 Raspador nasal
 Râpe nasale
 Raspa nasale

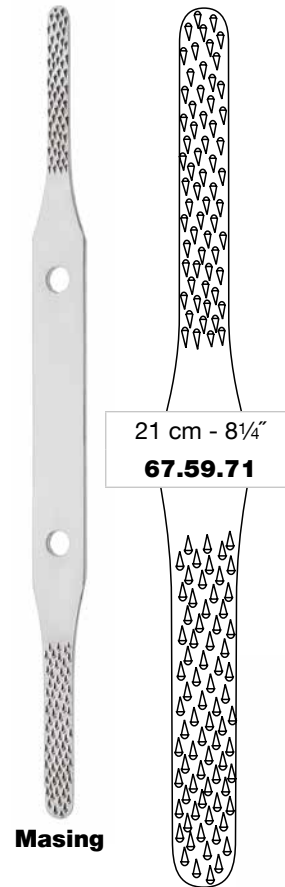

21 cm - 8¼"
67.59.71

Masing

Nasenfeile
 Nasal file
 Lima nasal
 Lime nasale
 Lima nasale



21 cm - 8¼"
67.59.70

Masing

Nasenraspel
 Nasal rasp
 Raspador nasal
 Râpe nasale
 Raspa nasale

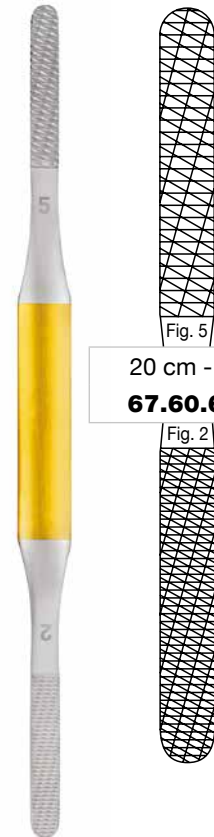

20 cm - 8"
67.60.65

Gubisch-Fomon "HM"

"HM"

Hartmetall
 Tungsten carbide
 Carburo de tungsteno
 Carbure de tungstène
 Carburo di tungsteno



C06

Nasenflügelhaken
Alar Retractors
Separadores para las alas nasales
Ecarteurs pour les ailes du nez
Divaricatori per alette nasali

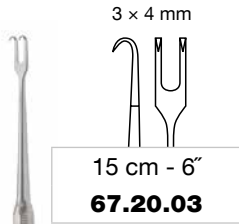

Cottle



Nasenflügelhaken
 Alar retractors
 Ganchos para las alas de la nariz
 Crochets pour ailes du nez
 Divaricatori per alette nasali

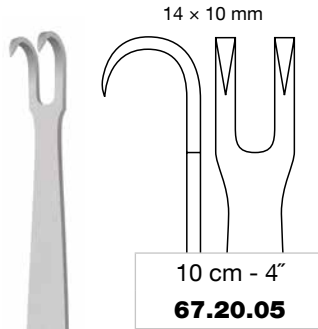

Kilner

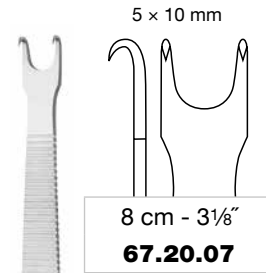

Gubisch-Kilner

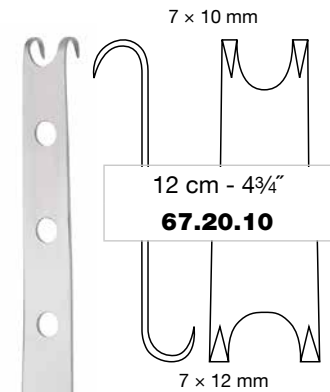

Converse



Cottle

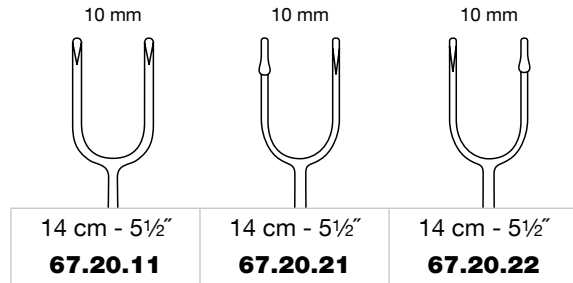

Alar- und Hauthaken
 Alar and skin hooks
 Ganchos para las alas de la nariz y la piel
 Crochets alaires et dermiques
 Divaricatori per alette nasali e pelle

Nasenflügelhaken
Alar Retractors
Separadores para las alas nasales
Ecarteurs pour les ailes du nez
Divaricatori per alette nasali

C06

mit Fingerring
 with finger ring
 con anillo
 avec bague
 con anello



Millard (Cottle)

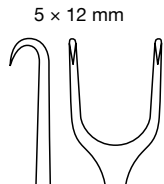

5 x 12 mm
 5,5 cm - 2 1/8"
67.20.23



Fomon

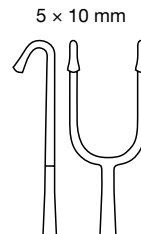

5 x 10 mm
 17 cm - 6 3/4"
67.20.25



Cottle

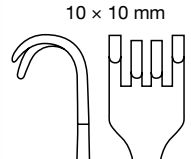

10 x 10 mm
 15 cm - 6"
67.20.44



Masing

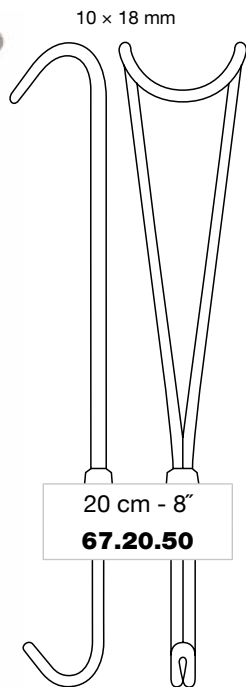

10 x 18 mm
 20 cm - 8"
67.20.50

mit Führungsrinne
 with guide channel
 con estria de guía
 avec cannelure
 con scanalatura



Neivert

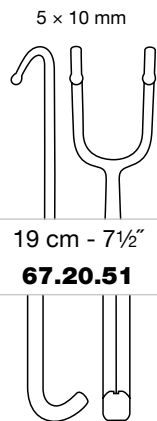

5 x 10 mm
 19 cm - 7 1/2"
67.20.51



Cottle-Neivert

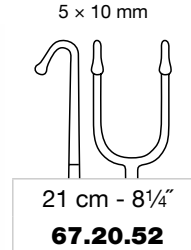

5 x 10 mm
 21 cm - 8 1/4"
67.20.52



C06

Nasenflügelhaken, Nasenhaken
Alar Retractors, Nasal Retractors
Separadores para las alas nasales, Separadores nasales
Ecarteurs pour les ailes du nez, Ecarteurs nasaux
Divaricatori per alette nasali, Divaricatori nasali



Cottle

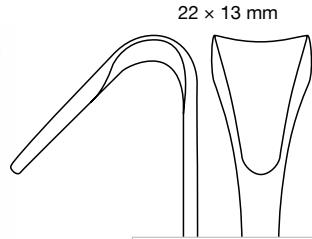

22 x 13 mm

15 cm - 6"

67.21.25



Cottle

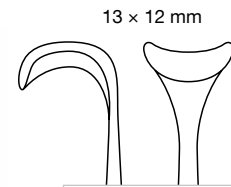

13 x 12 mm

14 cm - 5½"

67.21.15

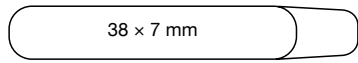

38 x 7 mm

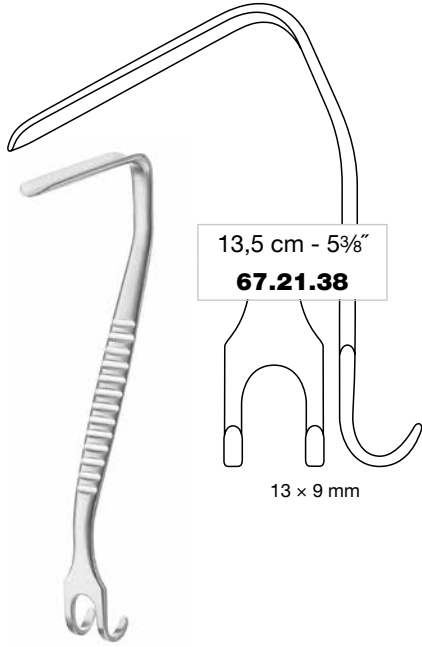

Aufricht

13,5 cm - 5⅝"

67.21.38

13 x 9 mm

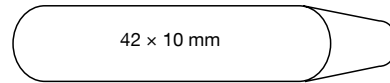

42 x 10 mm

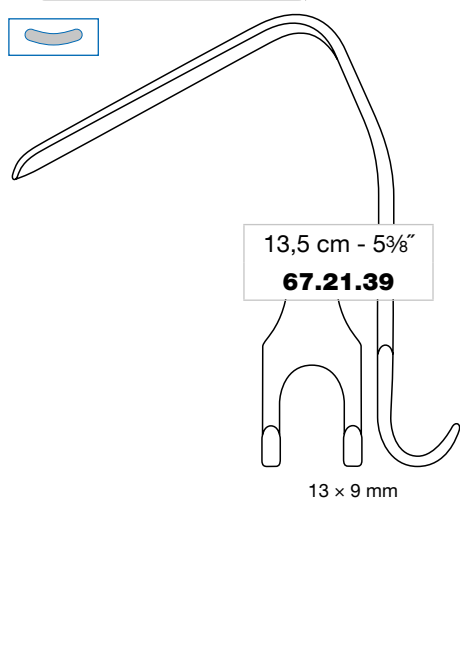

13,5 cm - 5⅝"

67.21.39

13 x 9 mm

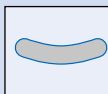

Wundhakenblatt, gewölbt
 Retractor blade, curved
 Hoja de separador, abovedada
 Lame d'écarteur, courbée
 Valva convessa

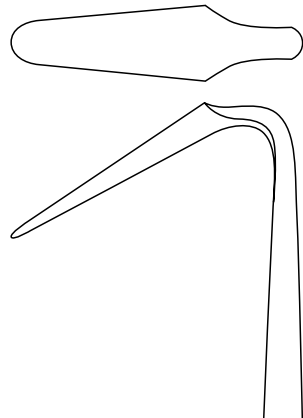

a = 30 mm
 b = 6/10 mm
 17 cm – 6¾"
67.21.32



Fischer-Aufricht

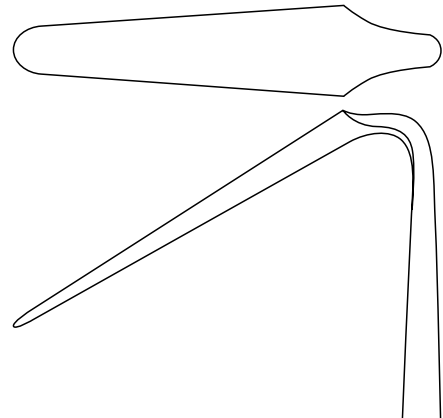

a = 50 mm
 b = 6/12 mm
 17 cm – 6¾"
67.21.33



a = 45 mm
 b = 7/10 mm
 18 cm – 7¼"
67.21.35



Aufricht

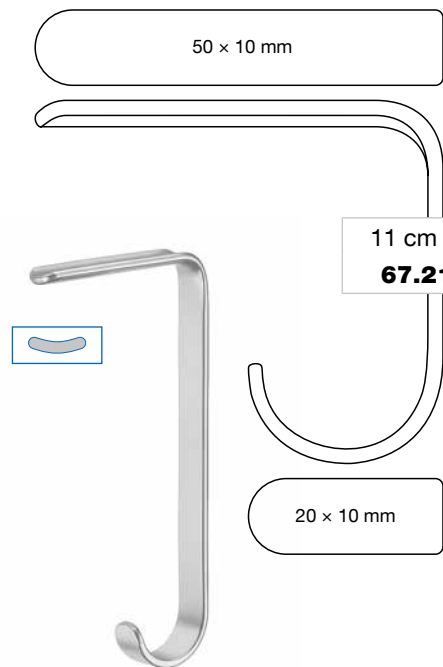

50 x 10 mm

11 cm – 4¾"
67.21.46

20 x 10 mm

Aufricht-Daniel

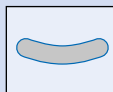

Wundhakenblatt, gewölbt
 Retractor blade, curved
 Hoja de separador, abovedada
 Lame d'ecarteur, courbée
 Valva di divaricatore, convessa



C06

Nasenhaken
Nasal Retractors
Separadores nasales
Ecarteurs nasaux
Divaricatori nasali



Aufricht-Walter

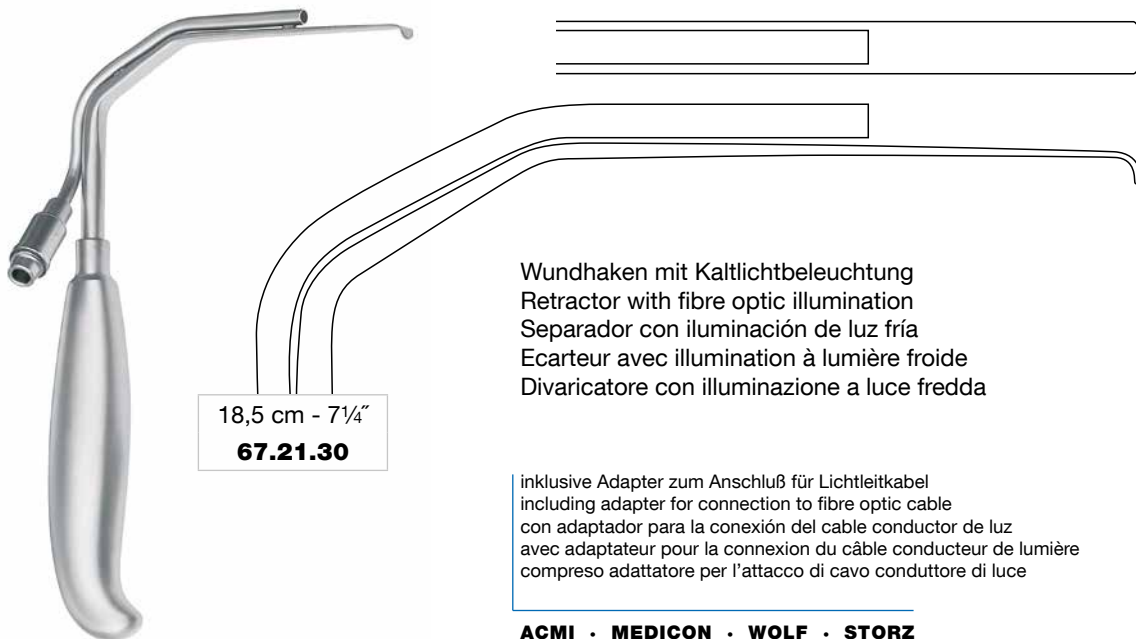

Walter

Wundhaken mit Kaltlichtbeleuchtung
Retractor with fibre optic illumination
Separador con iluminación de luz fría
Ecarteur avec illumination à lumière froide
Divaricatore con illuminazione a luce fredda

inklusive Adapter zum Anschluß für Lichtleitkabel
including adapter for connection to fibre optic cable
con adaptador para la conexión del cable conductor de luz
avec adaptateur pour la connexion du câble conducteur de lumière
compreso adattatore per l'attacco di cavo conduttore di luce

ACMI • MEDICON • WOLF • STORZ

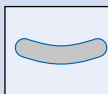

Wundhakenblatt, gewölbt
Retractor blade, curved
Hoja de separador, abovedada
Lame d'ecarteur, courbée
Valva di divaricatore, convessa

Nasentamponzangen
Nasal Dressing Forceps
Pinzas nasales para tamponiamento
Pinces à pansement pour le nez
Pinze per tamponiamento nasale

C07



18 cm - 7 1/8"
66.20.10

Feines Modell
 Delicate pattern
 Modelo fino
 Modèle fin
 Modello fine

Hartmann



20 cm - 8"
66.20.11

Standardmodell
 Standard pattern
 Modelo estándar
 Modèle standard
 Modello standard

Hartmann

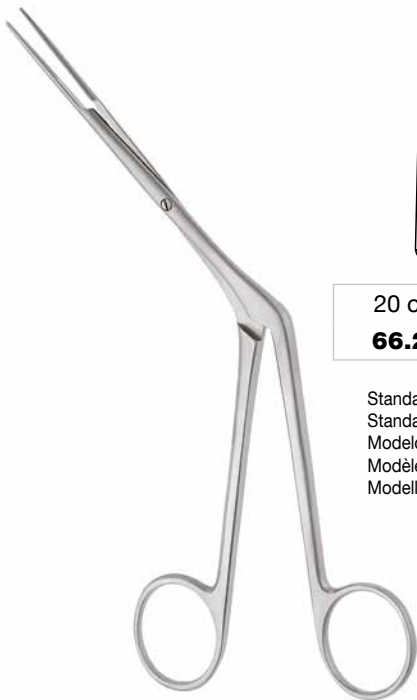

20 cm - 8"
66.20.25

Standardmodell
 Standard pattern
 Modelo estándar
 Modèle standard
 Modello standard

Westmacott

20 cm - 8"
66.20.27

Feines Modell
 Delicate pattern
 Modelo fino
 Modèle fin
 Modello fine



20 cm - 8"
66.20.28

Lubet-Barbon



C07

Nasenseptumzangen
Nasal Septum Forceps
Pinzas para el tabique nasal
Pinces pour la cloison nasale
Pinze per il setto nasale



19 cm - 7½"
66.25.11

1



19 cm - 7½"
66.25.12

2

Luc-Brünings (Heymann)

Vomerzangen
Vomer forceps
Pinzas para el vómer
Pinces à vomer
Pinze per vomere

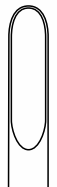

17 cm - 6¾"
66.25.15

Craig



17 cm - 6¾"
66.25.16



17 cm - 6¾"
66.25.17

Craig-Domnick

durchschneidend
 through-cutting
 cortantes
 coupantes
 taglienti

Maulbreite Jaw width Ancho de boca Largeur de mors Larghezza dei morsi		a = 11,5 cm - 4½"	a = 11,5 cm - 4½"
	2,0 mm	66.28.06	66.28.15
	2,5 mm	66.28.07	66.28.16
	3,0 mm	66.28.08	66.28.17

Weil-Blakesley



Maulbreite Jaw width Ancho de boca Largeur de mors Larghezza dei morsi		a = 11,5 cm - 4½"	a = 11,5 cm - 4½"	a = 11,5 cm - 4½"
	3,0 mm	66.28.59	66.28.60	66.28.61

Blakesley

**C07**



Nasenzangen
Nasal Forceps
Pinzas nasales
Pinces nasales
Pinze nasali

mit normalem Schaft
 with normal shaft
 con vástago normal
 à tige normale
 con asta normale

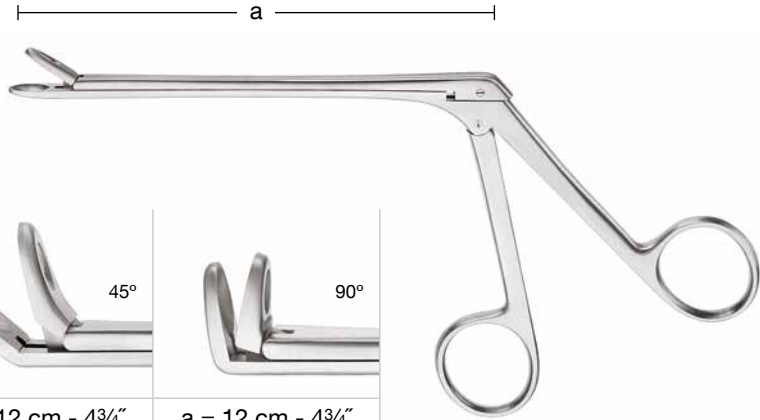
	Maulbreite Jaw width Ancho de boca Largeur de mors Larghezza dei morsi	  		
		a = 12 cm - 4¾"	a = 12 cm - 4¾"	a = 12 cm - 4¾"
# 1	3,0 mm	66.28.01	66.28.11	66.28.31
# 2	3,6 mm	66.28.02	66.28.12	66.28.32
# 3	4,2 mm	66.28.03	66.28.13	66.28.33
# 4	4,8 mm	66.28.04	66.28.14	66.28.34
# 5	5,6 mm	66.28.05		

**Weil-Blakesley**

mit schlankem Schaft
 with slim shaft
 con vástago delgado
 à tige élancée
 con asta sottile

	Maulbreite Jaw width Ancho de boca Largeur de mors Larghezza dei morsi	 	
		a = 12 cm - 4¾"	a = 12 cm - 4¾"
# 1	3,0 mm	66.28.71	66.28.81
# 2	3,6 mm	66.28.72	66.28.82
# 3	4,2 mm	66.28.73	66.28.83
# 4	4,8 mm	66.28.74	66.28.84
# 5	5,6 mm	66.28.75	

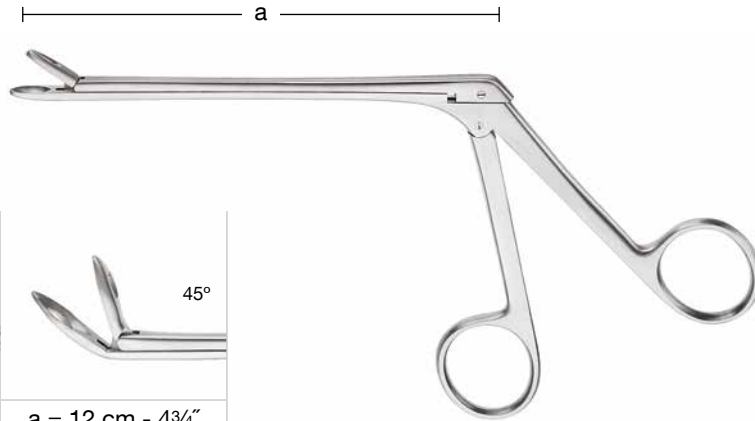
**Weil-Blakesley**

Nasensägen
Nasal Saws
Sierras nasales
Scies nasales
Seghe nasali

C07

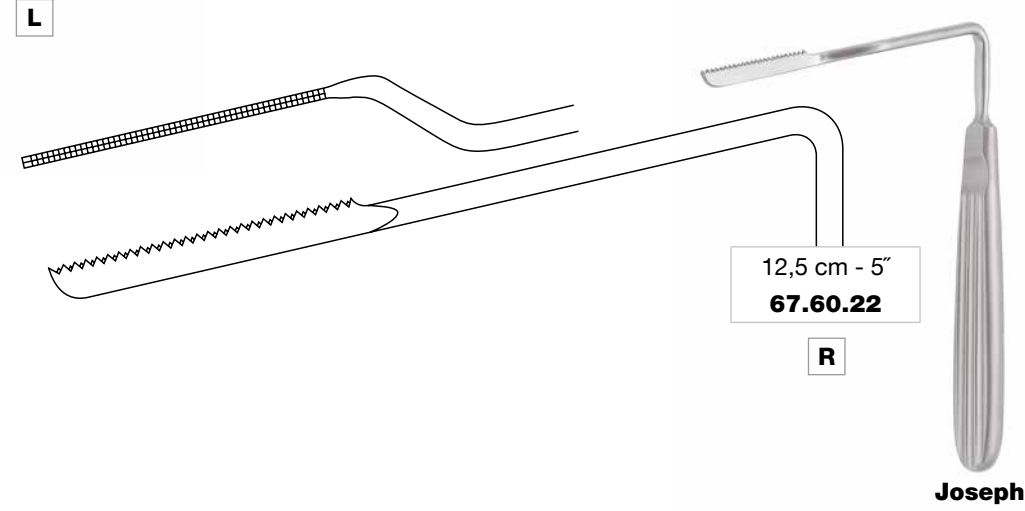
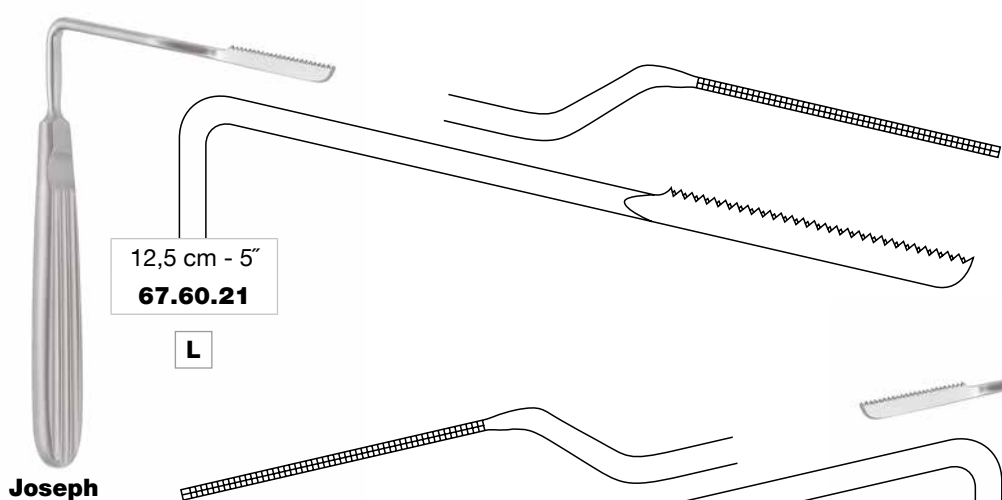
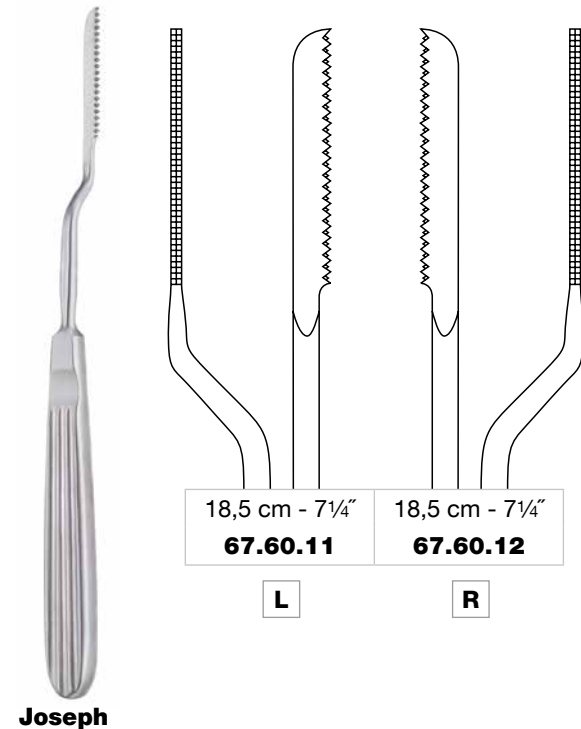
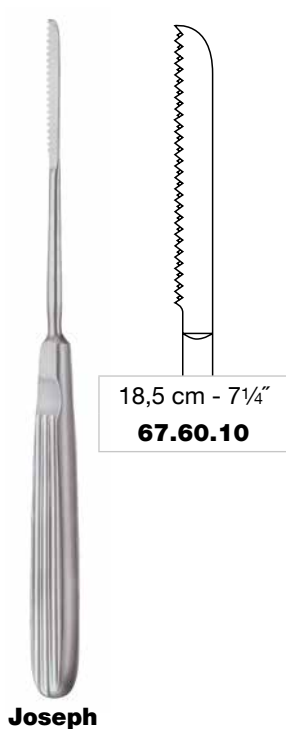

L nach links gewinkelt
 angled to the left
 en ángulo a la izquierda
 coudé à gauche
 angolato a sinistra

R nach rechts gewinkelt
 angled to the right
 en ángulo a la derecha
 coudé à droite
 angolato a destra



C08

Nasenseptumzangen
Nasal Septum Forceps
Pinzas para el tabique nasal
Pinces pour la cloison nasale
Pinze per il setto nasale

Septumrichtzangen
Septum straightening forceps
Pinzas para enderezar el tabique nasal
Pinces pour le redressement de la cloison nasale
Pinze per il rizzare setto nasale



23 cm - 9"
67.65.10

Walsham "Universal"



23 cm - 9"
67.65.11

R

Walsham

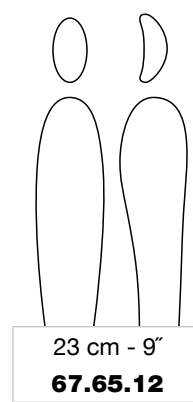

23 cm - 9"
67.65.12

L

L
links
left
izquierdo
gauche
sinistro

R
rechts
right
derecho
droite
destro

Nasenseptumzangen
Nasal Septum Forceps
Pinzas para el tabique nasal
Pinces pour la cloison nasale
Pinze per il setto nasale

C08

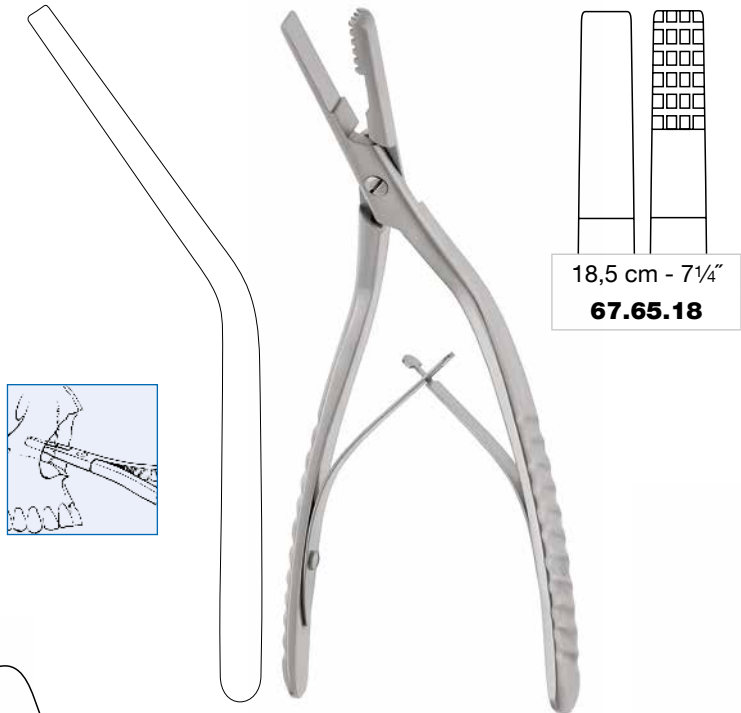

18,5 cm - 7¼"
67.65.18

Obwegeser

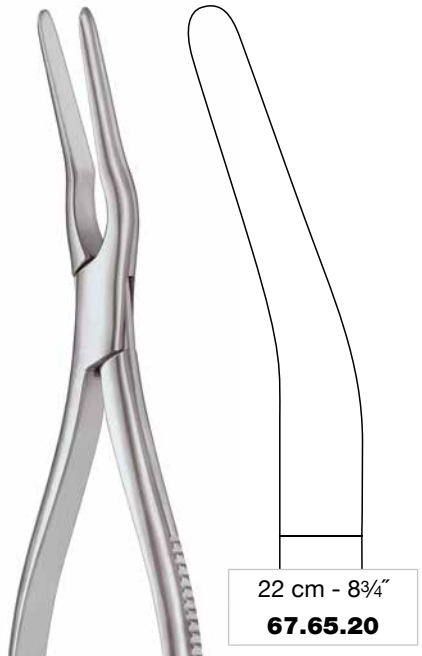
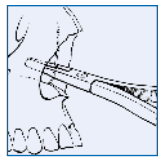

22 cm - 8¾"
67.65.20

Asch

Septumrichtzange
 Septum straightening forceps
 Pinza para enderezar el tabique nasal
 Pince pour le redressement de la cloison nasale
 Pinza per rizzare il setto nasale



4 mm
 21 cm - 8¼"
67.65.27

Obwegeser

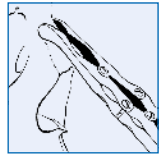



C08

Rhinoplastikmesser
Rhinoplasty Knives
Cuchillos para rinoplastia
Couteaux pour rhinoplastie
Coltelli per rinoplastica

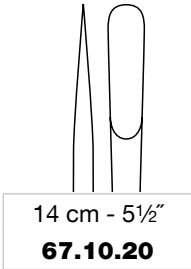

14 cm - 5½"
67.10.20

Cottle

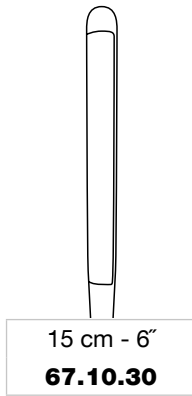

15 cm - 6"
67.10.30

Joseph

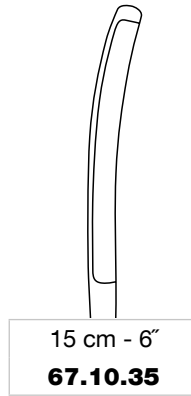

15 cm - 6"
67.10.35

Converse

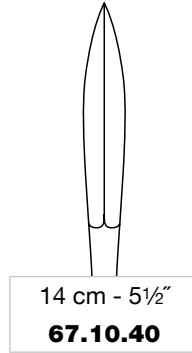

14 cm - 5½"
67.10.40

Cottle

Septum-Knorpelmesser
Septum cartilage knife
Cuchillo para cartilago del tabique nasal
Couteau à cartilages de la cloison nasale
Coltello per cartilagine del setto nasale

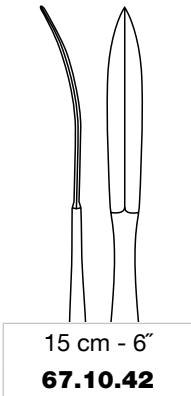

15 cm - 6"
67.10.42

Joseph

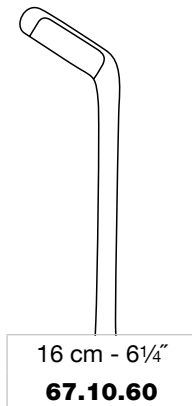

16 cm - 6¼"
67.10.60

Joseph

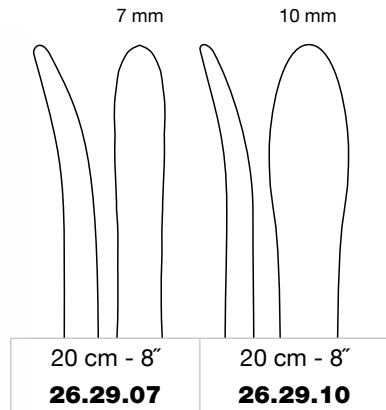

7 mm
20 cm - 8"
26.29.07

10 mm
20 cm - 8"
26.29.10

Langenbeck

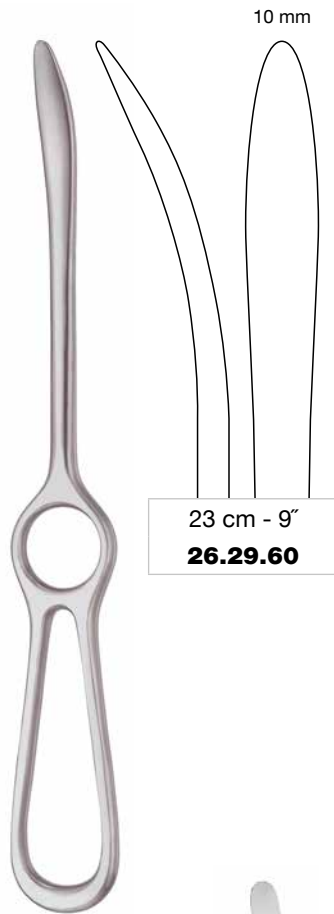

23 cm - 9"
26.29.60

Langenbeck

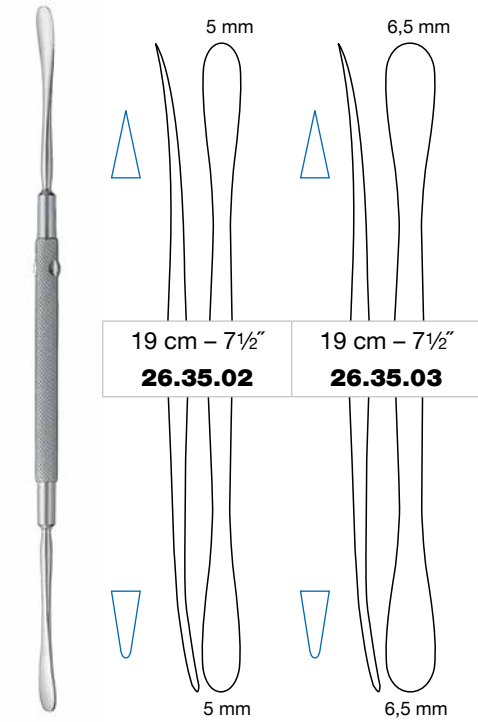

19 cm - 7½"
26.35.02

19 cm - 7½"
26.35.03

Freer



19 cm - 7½"
67.15.51

Cottle

Nasenfraktur-Elevatorium
Nasal fracture elevator
Elevador para fracturas nasales
Elévateur pour fractures nasales
Elevatore per fratture nasali

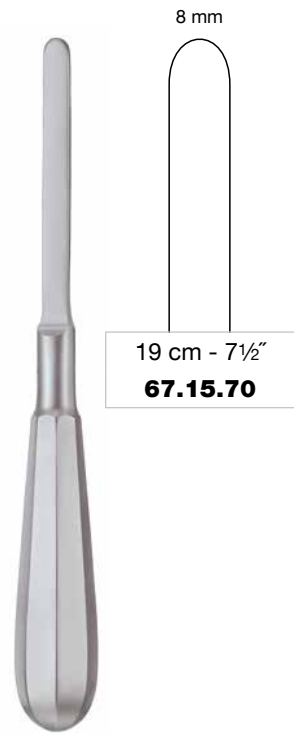

19 cm - 7½"
67.15.70

Boies



scharf
sharp
cortante
tranchant
tagliente



stumpf
blunt
roma
mousse
smussa



C09

Elevatorien
Elevators
Elevadores
Elévateurs
Elevatori



Septumfraktur-Elevatorium
 Elevator for fracture of septum
 Elevador para fracturas del tabique nasal
 Elévateur pour fractures de la cloison nasale
 Elevatore per fratture del setto nasale



Goldman



Reposition von Nasenbeinbrüchen
 Repositioning of nasal bone fractures
 Reposición de fracturas del hueso nasal
 Répositionnement de fractures de l'os nasal
 Riposizione di fratture dell'osso nasale



Saugelevatorien
 Suction elevators
 Elevadores aspiradores
 Elévateurs aspirantes
 Elevatori aspiranti

mit Mandrin
 with guide
 con mandril
 avec mandrin
 con mandrino



Haraldsson

Schlauchansatz, drehbar
 Tube connection, rotatable
 Empalme de tubo, giratorio
 Embout de tuyau, rotatif
 Attacco per il tubo, girevole

Septum-Elevatorien
Septum Elevators
Elevadores para el tabique nasal
Élévateurs pour la cloison nasale
Elevatori per il setto nasale



C09

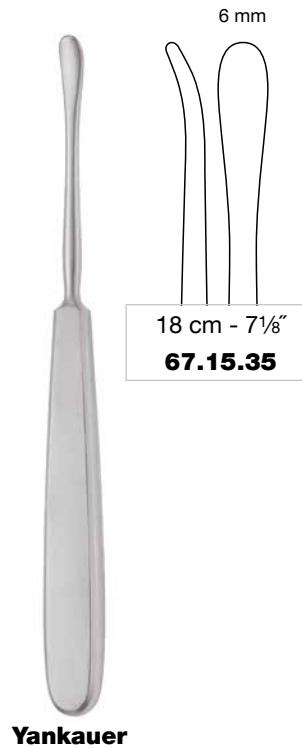
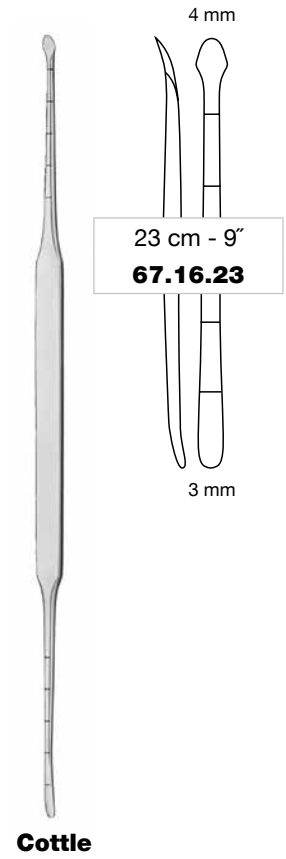
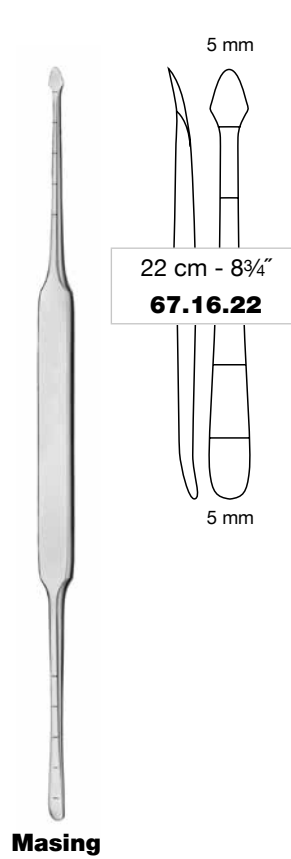
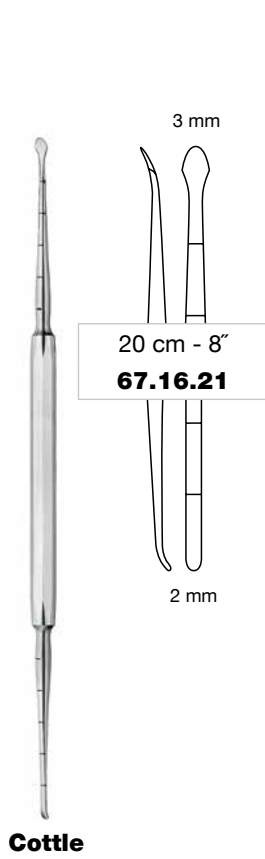



C09

Mukosamesser
Mucosa Knife
Cuchillo para mucosa
Couteau à muqueuse
Coltello per mucosa



66.52.10
Freer

Mukosamesser zur Präparation des Übergangs von knorpeligem zu knöchernem Septum.

Mucosa scalpel for preparation of the transition from the cartilaginous to the bony septum.

Cuchillo de mucosa para preparación de la transición del tabique cartilaginoso al tabique óseo.

Couteau à muqueuse pour la préparation de la transition entre le septum cartilagineux et le septum osseux.

Coltello per mucosa per la preparazione del passaggio dal setto cartilagineo al setto osseo.

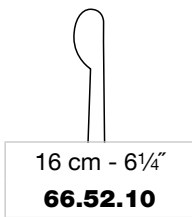

16 cm - 6 1/4"
66.52.10

Freer



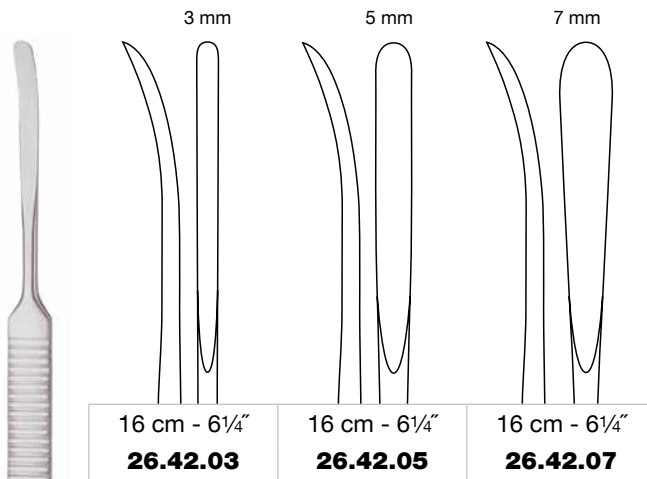

Williger

Präparation des Zugangs für die laterale Osteotomie
Preparation of the access for the lateral osteotomy
Dissección del acceso de la osteotomía lateral
Dissection de l'accès pour l'ostéotomie latérale
Dissezione dell'accesso per l'osteotomia laterale

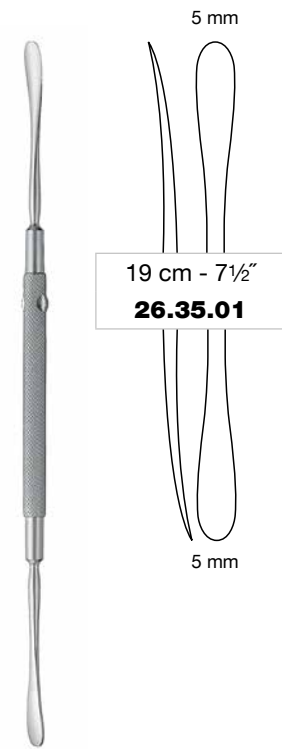

Freer

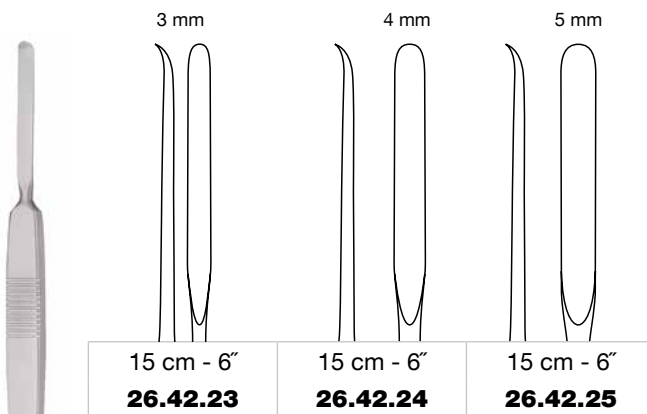

McKenty

Präparation des unteren Nasenganges
Dissection of the meatus inferior
Dissección del meato inferior
Dissection du canal nasal inférieur
Dissezione del meato nasale inferiore



Raspatorien
Raspatories
Legras
Rugines
Periostotomi

C10

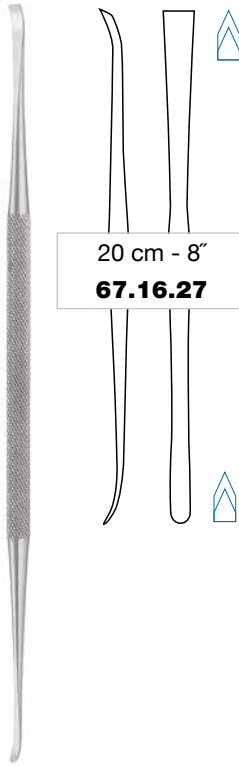

20 cm - 8"
67.16.27

Daniel-Çakir

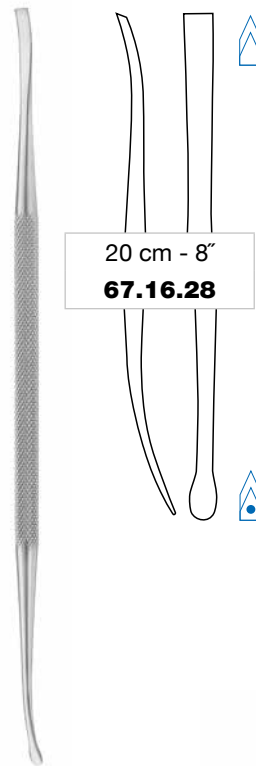

20 cm - 8"
67.16.28

Daniel-Çakir

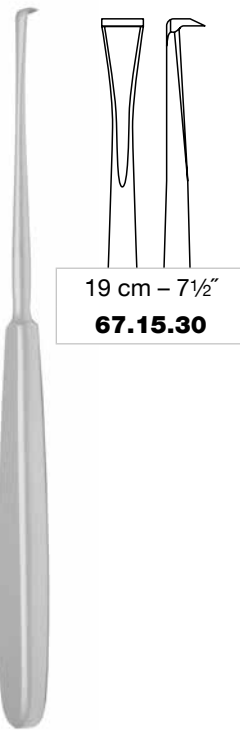

19 cm - 7½"
67.15.30

Çakir

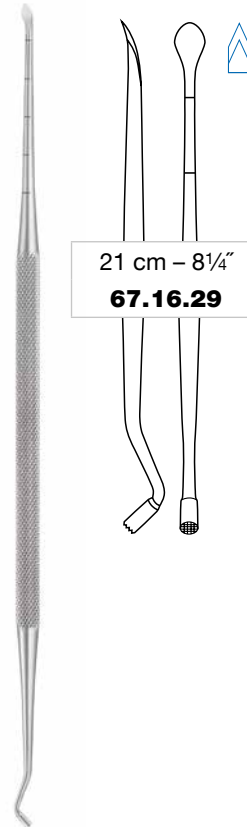

21 cm - 8¼"
67.16.29

Cottle-Daniel



halbscharf
semi sharp
semi cortante
semi tranchant
semi tagliente



scharf
sharp
cortante
tranchant
tagliente

Tunnelier-Raspatorium
Tunneling raspatory
Legra tunelizadora
Rugine à tunnellation
Periostotomo scollatore

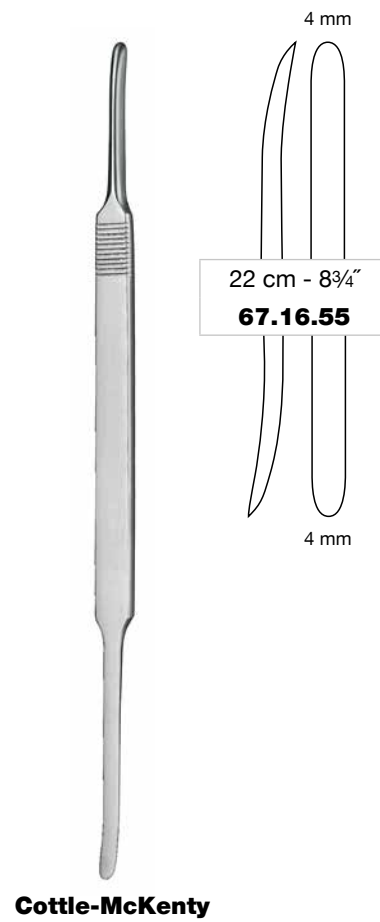
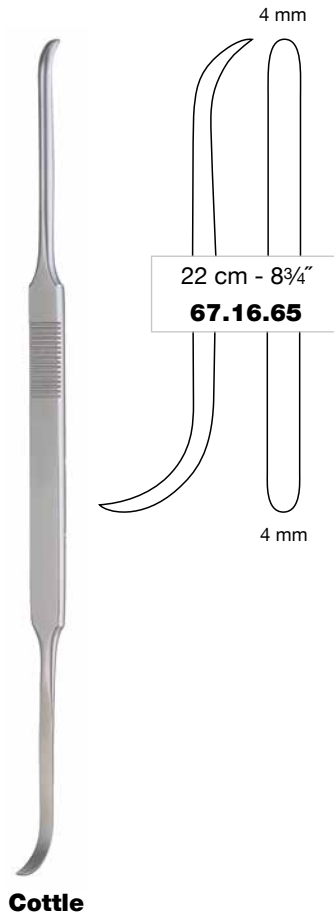



Saug-Raspatorien
Suction Raspatories
Legras aspiradoras
Rugines aspirantes
Periostotomi aspiranti

C10



Ideal zur präzisen subperichondralen Präparation am Septum und subperiostalen Präparation des Os turbinale.

Ideal for precise subperichondral preparation at the septum and subperiosteal preparation of the osturbinal.

Ideal para la preparación subpericondrial precisa en el tabique y preparación subperióstica del hueso turbinado.

Idéal pour la préparation souspérichondrale sur le septum et la préparation souspériostée de l'osturbinal.

Ideale per una precisa preparazione subpericondrale del setto e per la preparazione subperiostale dell'osturbinale.



4 mm

20 cm - 8"
67.15.93

4 mm

20 cm - 8"
67.15.94

4 mm

17 cm - 6¾"
67.15.97

Bypass

Bypass

mit Mandrin
with guide
con mandril
avec mandrin
con mandrino

Gubisch

Gubisch

mit Kunststoffbacken (abschraubbar)
with plastic facings (detachable)
con frentes de material plástico (destornillables)
avec joues en matière plastique (dévissables)
con guancie di plastica (svitabili)



1:2.5

27.06.21

Ersatzbacken, Paar
Spare facings, pair
Frentes de repuesto, par
Joues de rechange, paire
Guancie di ricambio, paio

	18,5 cm – 7¼"	27.06.20	200 g	Ø 25 mm
--	---------------	-----------------	-------	---------



1:2.5

	24,5 cm – 9¾"	27.10.40	140 g	Ø 43 mm
	25,0 cm – 10"	27.10.41	226 g	Ø 50 mm

Die gewölbte Seite ist für die Knorpelquetsche (67.19.70). Siehe Seite 194
The round face is used for the cartilage crusher (67.19.70). See page 194
La cara convexa se usa para la machacadera de sustancia cartilaginosa (67.19.70). Véase página 194
La face convexe s'emploie pour presser la matière cartilagineuse (67.19.70). Voir page 194
La faccia convessa si usa per la trita cartilagine (67.19.70). Vedi pagina 194



1:2.5

plan/konvex
plane/convex
plano/convexo
plane/convexe
piano/convesso

Cottle	19 cm – 7½"	67.40.20	300 g	Ø 30 mm
---------------	-------------	-----------------	-------	---------

mit schrägen Flächen
with inclined facings
con frentes oblicuas
avec joues obliques
con guancie inclinate



1:2.5

Guillen	24 cm – 9½"	67.40.75	300 g	Ø 30 mm
----------------	-------------	-----------------	-------	---------



Kunststoffgriff (autoklavierbar bis 134 °C bei 3 bar)
Plastic handle (autoclavable up to 134 °C at 3 bar)
Mango de plástico (autoclavable hasta 134 °C bajo presión de 3 bar)
Manche en plastique (autoclavable à 134 °C sous pression de 3 bars)
Manico di plastica (autoclavabile fino a 134 °C sotto pressione di 3 bar)



Hohlmeißel
Gouges
Gubias
Gouges
Sgorbie

C11

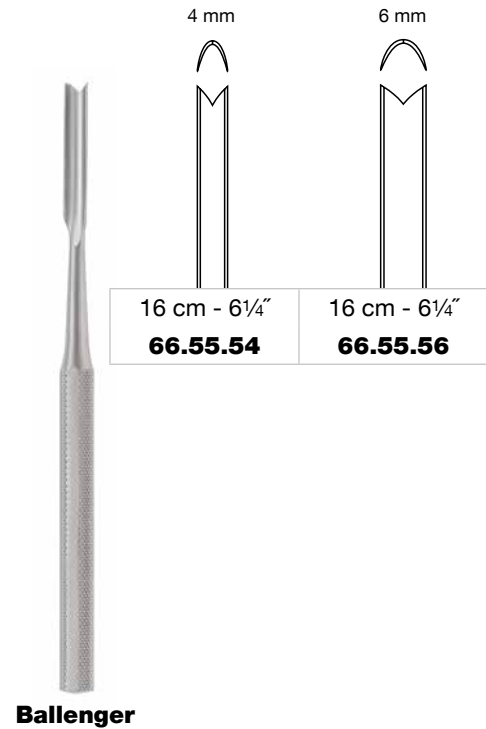
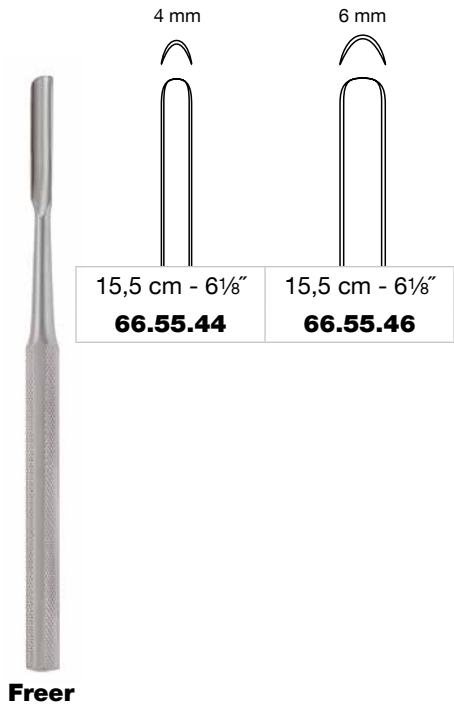

Septum-Hohlmeißel
Septum gouges
Gubias para el tabique nasal
Gouges pour la cloison nasale
Sgorbie per il setto nasale



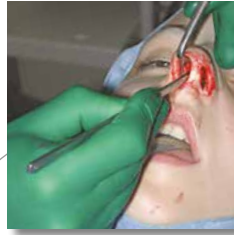

Cottle-Gubisch

Sehr flache Schnittkante - die eingestellte Osteotomie-Ebene bleibt kontinuierlich erhalten und führt zu einer präzisen Durchtrennung.

Extremely flat cutting edge - the set osteotomy level is continuously retained, leading to precise detachment.

Canto de corte muy plano - el plano de osteotomía ajustado se mantiene continuo y permite una separación precisa.

Arête de coupe très plate - le plan d'ostéotomie qui a été réglé demeure de façon continue et conduit à une séparation précise.

Spigolo tagliente molto piatto - il livello prestabilito della osteotomia viene mantenuto in modo continuo e porta ad una separazione precisa.

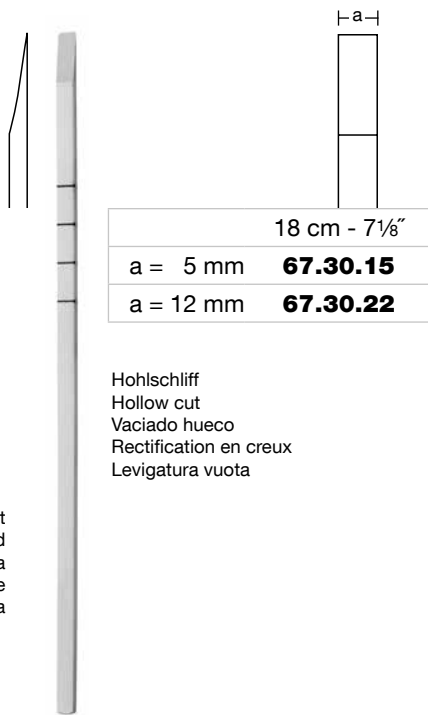

Cottle-Gubisch

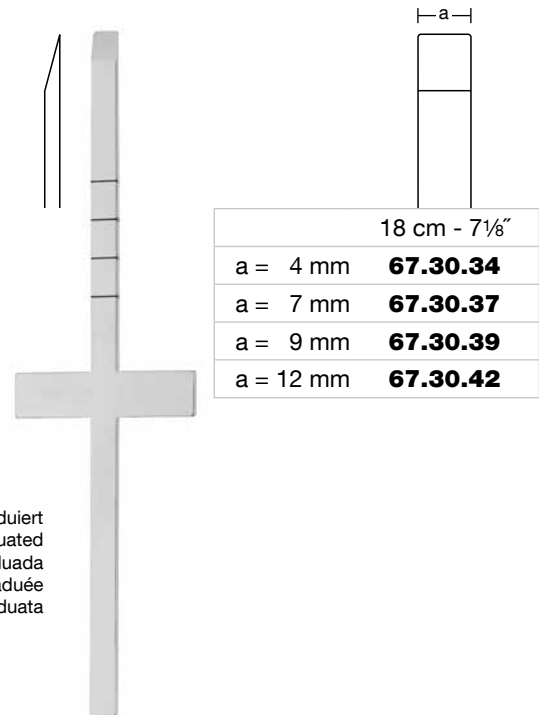

Cottle



Osteotome, Flachmeißel
Osteotomes, Chisels
Ostéotomes, Cinceles
Ostéotomes, Ciseaux burins
Osteotomi, Scalpelli

C12



“Fischschwanz”
“Fishtail”
“Cola de pez”
“Queue de poisson”
“Coda di pesce”

16 mm
18 cm - 7 1/8"
67.31.86

graduier
graduated
graduada
graduée
graduata

Cottle

12 mm 14 mm 16 mm
8 mm 10 mm 12 mm
18 cm - 7 1/8" 18 cm - 7 1/8" 18 cm - 7 1/8"
67.33.12 **67.33.14** **67.33.16**

Rubin

19 cm - 7 1/2"
a = 3 mm **67.31.73**
a = 5 mm **67.31.75**

Walter

19 cm - 7 1/2"
a = 3 mm **67.34.03**
a = 5 mm **67.34.05**
a = 12 mm **67.34.33**

Walter

Osteotome, Flachmeißel
Osteotomes, Chisels
Ostéotomes, Cinceles
Ostéotomes, Ciseaux burins
Osteotomi, Scalpelli

C12

Osteotome
 Osteotomes
 Osteótomos
 Ostéotomes
 Osteotomi



Walter

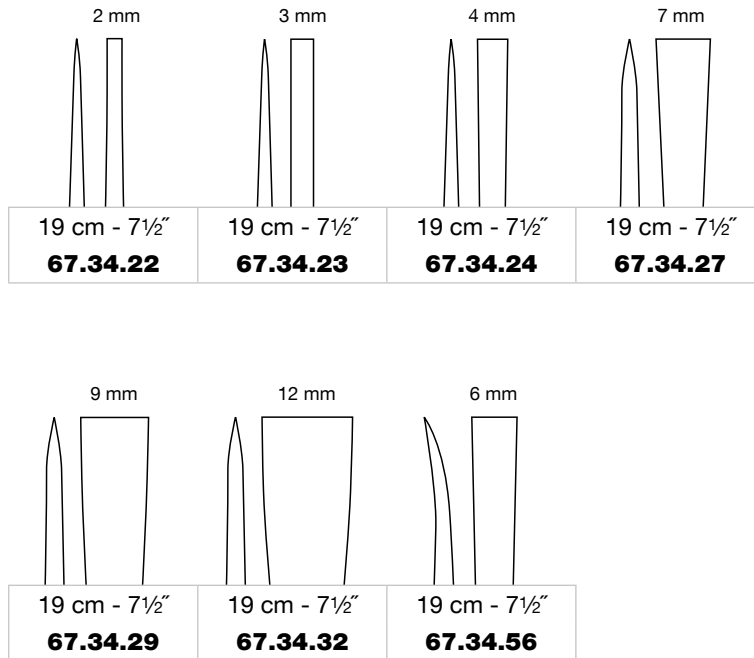

McIndoe

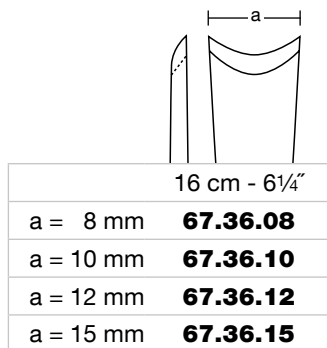

Moberg

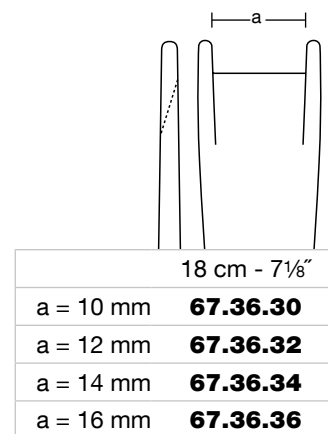

**C12**

Osteotome
Osteotomes
Osteótomos
Ostéotomes
Osteotomi

**67.30.53**

- Ideal für direkte, transversale Osteotomie durch die Haut
- Sicherer Halt und präzise Führung
- Ideal for direct transversal osteotomy
- Reliable transcutaneous grip and precise guidance
- Ideal para osteotomía directa y transversal transcutánea
- Manejo seguro y preciso
- Idéal pour l'ostéotomie directe et transversale transcutanée
- Tenue sûre et guidage précis
- Ideale per le osteotomie transcutanee dirette e trasversali
- Permettendo una tenuta stabile e una guida precisa



Aluminiumgriff
 Aluminium handle
 Mango de aluminio
 Manche en aluminium
 Manico in alluminio

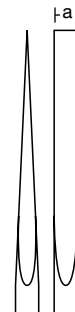

	20 cm - 8"
a = 2 mm	67.30.52
a = 3 mm	67.30.53

Gubisch

graduiert
 graduated
 graduada
 graduée
 graduata

	18 cm - 7 ¹ / ₈ "
a = 4 mm	67.30.04
a = 7 mm	67.30.07
a = 9 mm	67.30.09
a = 12 mm	67.30.12

Cottle

"Fischschwanz"
 "Fishtail"
 "Cola de pez"
 "Queue de poisson"
 "Coda di pesce"

16 mm

	18 cm - 7 ¹ / ₈ "
	67.31.16

graduiert
 graduated
 graduada
 graduée
 graduata

Cottle

3 mm

	17 cm - 6 ³ / ₄ "
	67.30.60

Çakir



C12

Osteotome
Osteotomes
Osteótomos
Ostéotomes
Osteotomi



schmal
 narrow
 delgado
 élancé
 sottile

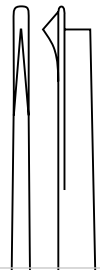

19,5 cm - 7³/₄"
67.33.03

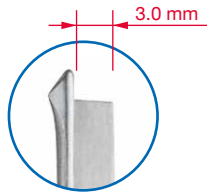

Fanous-Gubisch

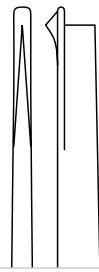

19,5 cm - 7³/₄"
67.33.04



19,5 cm - 7³/₄"
67.33.05

R

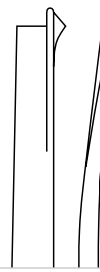

19,5 cm - 7³/₄"
67.33.06

L

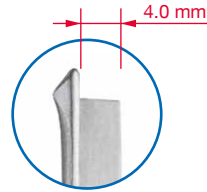

Fanous



- ▶ Der Operateur orientiert sich mittels des lateralen Führungsdorns über die Meißelposition
- ▶ Minimale Traumatisierung
- ▶ Bevorzugte Anwendung für die laterale Osteotomie bei enoralem und endonasalem Zugang
- ▶ The surgeon orientates the position of the chisel through the lateral guiding thorn
- ▶ Minimal traumatization
- ▶ Preferred application for lateral osteotomy with enoral and endonasal access
- ▶ El cirujano se orienta mediante la espina da guía lateral para determinar la posición del cincel
- ▶ Traumatización mínima
- ▶ Aplicación preferida para la osteotomía lateral con acceso intraoral y intranasal
- ▶ L'opérateur s'oriente par l'épine latérale de guidage pour déterminer la position du burin
- ▶ Traumatisme minimal
- ▶ S'utilise surtout pour l'ostéotomie latérale sous accès énorale et endonasal
- ▶ Il chirurgo può determinare la posizione dello scalpello attraverso la spina guida
- ▶ Traumatismo minimo
- ▶ Applicazione preferita per osteotomia laterale con accesso enorale ed endonasale

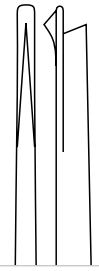

19,5 cm - 7³/₄"
67.37.25



19,5 cm - 7³/₄"
67.37.30

R



19,5 cm - 7³/₄"
67.37.35

L

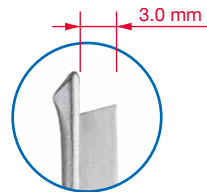

Schrom

L links
 left
 izquierdo
 gauche
 sinistro

R rechts
 right
 derecho
 droite
 destro

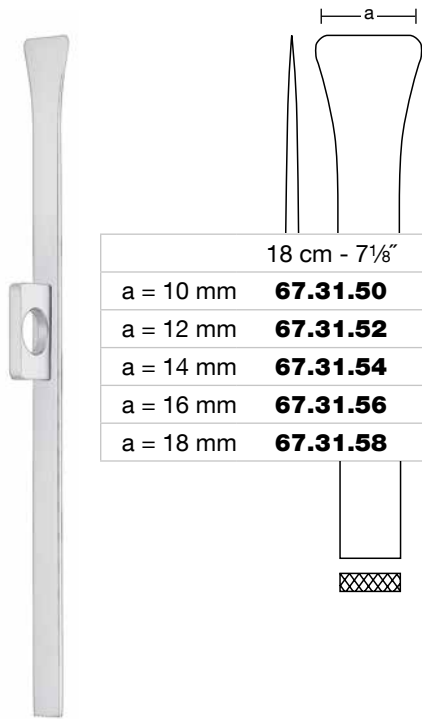

	18 cm - 7 1/8"
a = 10 mm	67.31.50
a = 12 mm	67.31.52
a = 14 mm	67.31.54
a = 16 mm	67.31.56
a = 18 mm	67.31.58

Rubin

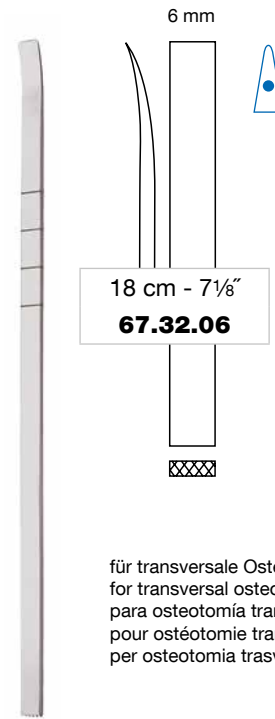

	18 cm - 7 1/8"
	67.32.06

graduirt
 graduated
 graduada
 graduée
 graduata

für transversale Osteotomie
 for transversal osteotomy
 para osteotomía transversal
 pour ostéotomie transversale
 per osteotomia trasversale

Cottle

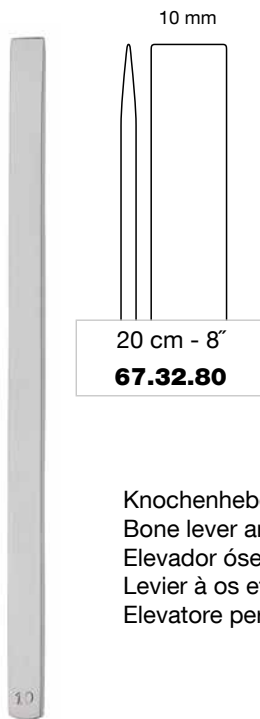

	20 cm - 8"
	67.32.80

Cottle

Knochenhebel und Spaltosteotom
 Bone lever and splitting osteotome
 Elevador óseo y osteótomo para hender hueso
 Levier à os et ostéotome à fendre
 Elevatore per ossa e osteotomo per fendere osso

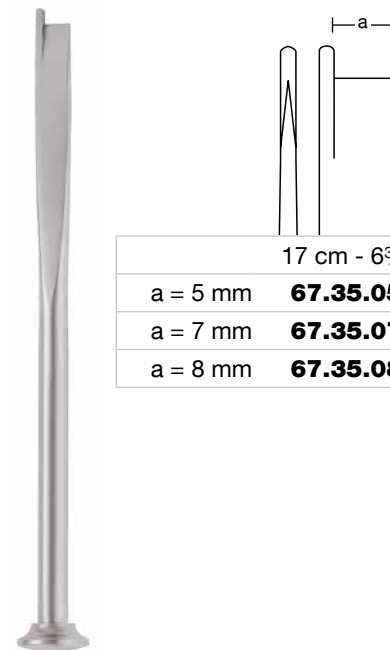

	17 cm - 6 3/4"
a = 5 mm	67.35.05
a = 7 mm	67.35.07
a = 8 mm	67.35.08

Fomon

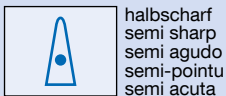



C12

Osteotome
Osteotomes
Osteótomos
Ostéotomes
Osteotomi

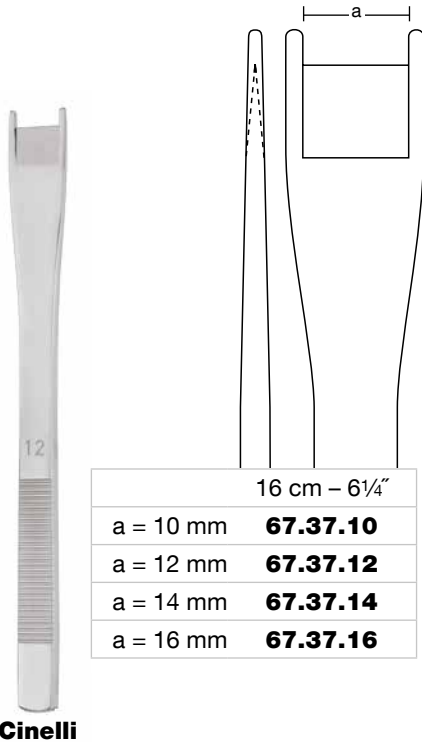

Cinelli

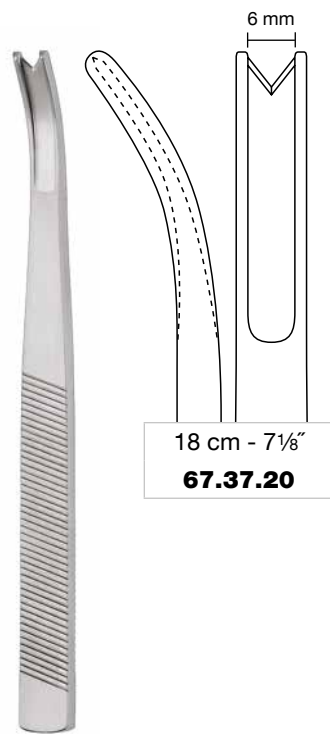

Blume



Silver

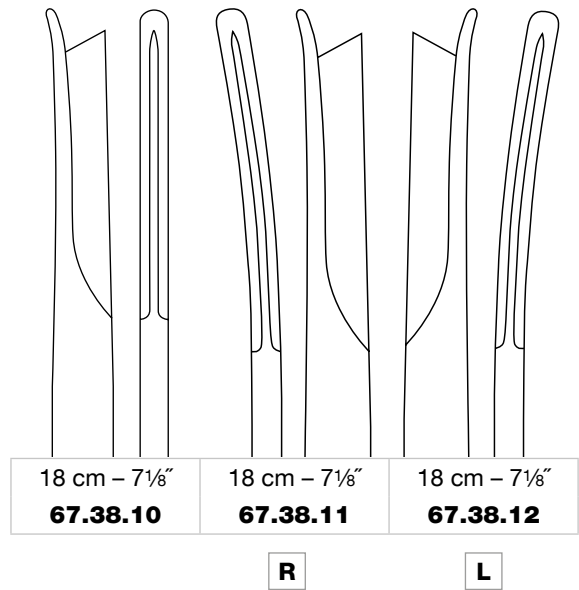

67.37.20
für die laterale Osteotomie
for lateral osteotomy
para la osteotomía lateral
pour l'ostéotomie latérale
per osteotomia laterale

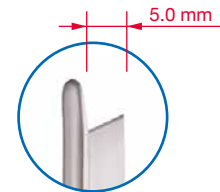

L
links
left
izquierdo
gauche
sinistro

R
rechts
right
derecho
droite
destro

Nasenseptum-Osteotome
 Nasal septum osteotomes
 Osteótomos para el tabique nasal
 Ostéotomes pour la cloison nasale
 Osteotomi per il setto nasale

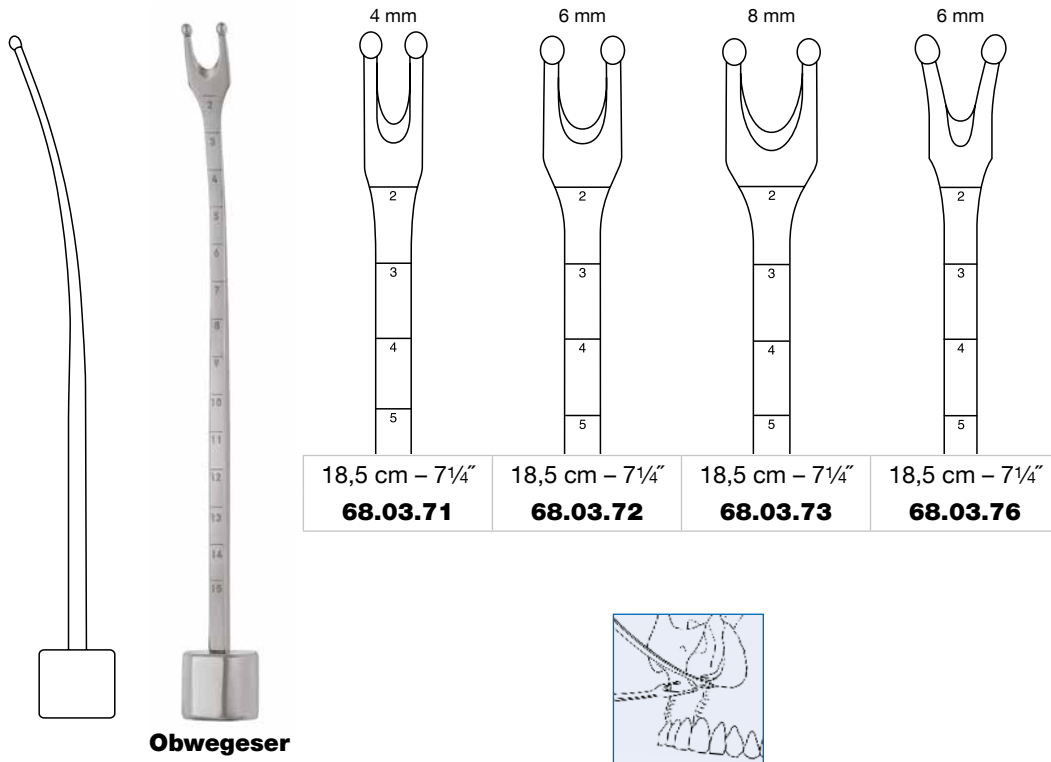



Knorpel- und Knocheninstrumente
Cartilage and Bone Instruments
Instrumentos para cartilago y huesos
Instruments à cartilage et os
Strumenti per cartilagine e ossa

C13

Knorpelquetschen
 Cartilage crushers
 Trituradora de sustancia cartilaginosa
 Presses pour matière cartilagineuse
 Trita cartilagine

65 × 30 × 30 mm



mit Entnahmeklammer
 with clamp for taking out the prepared material
 con grapa de toma para sacar el material machacado
 avec pince pour enlever la matière pressée
 con pinza per prendere il materiale tritato

67.19.70
Cottle



Durch adaptierten Druck entsteht ein flaches, flexibles Knorpelvlies welches vielfältig einsetzbar ist.

Due to an adapted pressure a flat, flexible cartilage transplant is obtained, which can be applied in various manners.

Mediante una presión adaptada se crea un tejido de cartilago plano y flexible el cual puede ser empleado de diversas maneras.

Une pression adaptée permet de créer un transplant de cartilage plan et flexible qui peut être posé variablement.

Mediante una pressione adatta si crea un tessuto di cartilagine piano e flessibile, il quale può essere utilizzato in modi diversi.

65 × 30 mm



67.19.80
Gubisch



Knorpelschneidblöcke
Cartilage Cutting Blocks
Bloques para cortar cartilago
Blocs pour couper le cartilage
Blocchi per tagliare cartilagine

C13



67.19.76
 85 × 55 × 10 mm
 PPSU



67.19.79
 85 × 55 × 10 mm
 ALUMINIUM



Raster
 Grate
 Cuadrícula
 Quadrillage
 Quadro 70 x 40 mm

67.19.77
 100 × 60 × 10 mm
 PROPYLUX

Ein Propylux-Schneidblock ermöglicht direktes Schneiden mit nur minimaler Abnutzung der Skalpellklinge.

Cutting block made from Propylux allows direct carving with minimal damage to knife blades.

La cuadrícula de Propylux permite el tallado directo dañando mínimamente las hojas del cuchillo.

Le bloc à couper le cartilage fabriqué à partir de «Propylux» permet de tailler directement sans endommager les lames du couteau.

Un blocco per tagliare la cartilagine in Propylux permette di effettuare direttamente l'incisione danneggiando al minimo le lame del bisturi.



“Dicing Block”

67.19.81
 120 × 120 × 15 mm
 PROPYLUX



Kunststoff (autoklavierbar bis 134 °C bei 3 bar)
 Plastic (autoclavable up to 134 °C at 3 bar)
 Plástico (autoclavable hasta 134 °C bajo presión de 3 bar)
 Plastique (autoclavable à 134 °C sous pression de 3 bars)
 Plastica (autoclavabile fino a 134 °C sotto pressione di 3 bar)



Knorpel- und Knocheninstrumente, Fräser
Cartilage and Bone Instruments, Cutting Burrs
Instrumentos para cartilago y huesos, Fresas
Instrumenti à cartilage et os, Fraises
Strumenti per cartilagine e ossa, Frese

C13



Klemmen
 Forceps
 Pinzas
 Pinces
 Pinze

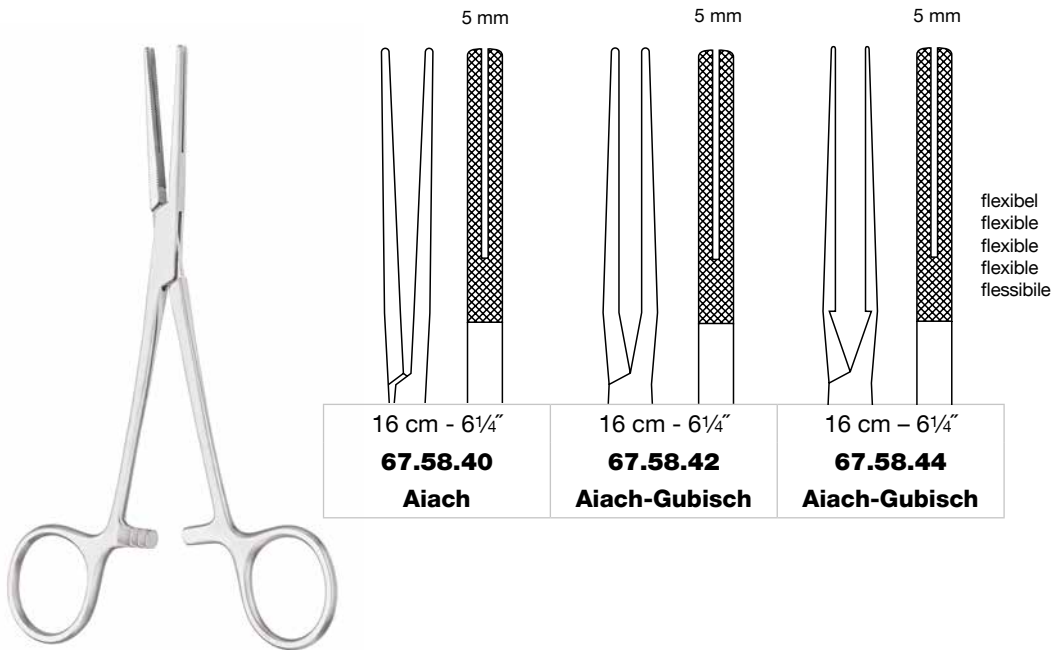

Knorpel-Quetschzange
 Cartilage morselizer forceps
 Pinza aplastadora de cartílagos
 Pince presse-cartilage
 Pinza trita cartilagine

25 x 20 mm



Fräser
 Cutting burrs
 Fresas
 Fraises
 Frese

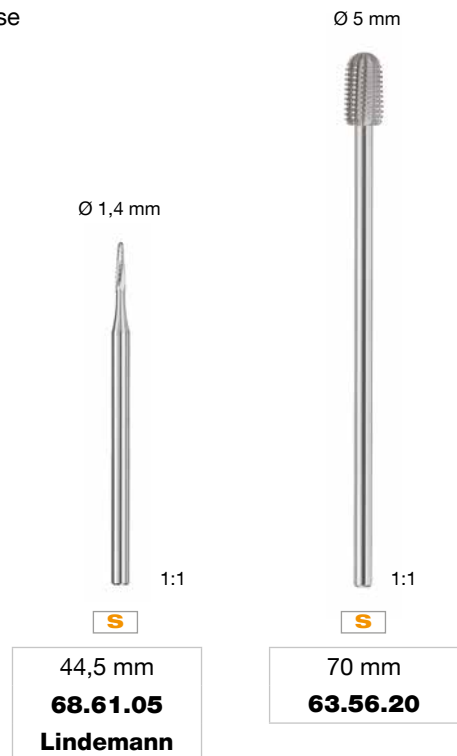

Fräser mit Standard-Ansatz (Schaft-Ø 2,35 mm)
 Cutting Burrs with standard shank end (Shaft Ø 2,35 mm)
 Fresas con talón estándar (Ø de vástago 2,35 mm)
 Fraises avec embout standard (Ø de tige 2,35 mm)
 Frese con attacco standard (Ø dell'asta 2,35 mm)

Septum-Quetschzangen
 Septal morselizer forceps
 Pinzas para aplastamiento del tabique nasal
 Pincés pour aplatissement de la cloison nasale
 Pinze per appiattimento del setto nasale

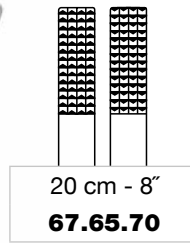

Rubin

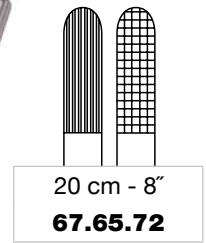

Gubisch-Rubin "HM"

Schutzkappe
 Protective cap
 Caperuza protectora
 Capuchon protecteur
 Cappuccio di protezione



67.65.71

Die Schutzkappe kann je nach Bedarf auf rechtes oder linkes Maulteil umgesteckt werden.

According to the requirements of operation, the cap may be placed either on the right or the left jaw.

En caso de necesidad, la caperuza protectora puede colocarse sobre la parte derecha o la parte izquierda de la boca de la pinza.

Selon le besoin, le capuchon protecteur se posera sur le mors droit ou sur le mors gauche.

Il cappuccio può essere applicato indifferentemente sul morso destro oppure sinistro.

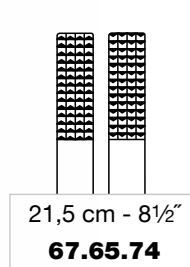

Rubin

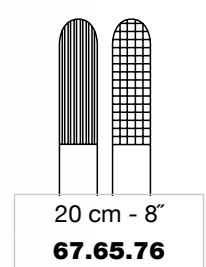

Rubin "HM"



Markierungs- und Messinstrumente
Marking and Measuring Instruments
Instrumentos para marcar y medir
Instrumenti à mesurer et marquer
Strumenti per marcare e misurare

C13



Gubisch

Zur Markierung von Inzisionslinien auf der Haut/Schleimhaut.
 For the marking of incision lines on the skin/mucous membrane.
 Para marcar líneas de incisión en la piel/mucosa.
 Pour le repérage des traits d'incision sur la peau/la muqueuse.
 Per marcare le linee di incisione sulla cute e sulla mucosa.



P₁₀
44.90.72

Feder
 Pen
 Pluma
 Plume
 Piuma



13 cm - 5 1/8"
44.90.70

Federhalter
 Pen holder
 Porta-plumas
 Porte-plume
 Porta-piuma

Gubisch

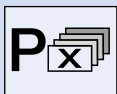

Verpackungseinheit "X" Stück
 Packing unit "X" pieces
 Paquete de "X" unidades
 Emballage de "X" pièces
 Confezione da "X" pezzi



Markierungs- und Messinstrumente
Marking and Measuring Instruments
Instrumentos para marcar y medir
Instrumenti à mesurer et marquer
Strumenti per marcare e misurare

C14

Messzirkel
 Caliper
 Compas
 Compas
 Compasso



8 cm - 3 1/8"
60.00.40

Calastroviejo

Stablehre
 Gauge rod
 Calibre
 Guide
 Calibro



graduiert in mm
 graduated in mm
 graduado en mm
 graduée en mm
 graduato in mm

17 cm - 6 3/4"
67.90.05

Joseph



Nasenspitzenmarkierer
 Nose tip markers
 Marcadores de la punta de la nariz
 Marqueurs du bout du nez
 Marcatori della punta del naso



12 cm - 4 3/4"
60.00.45

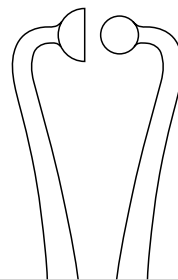

14,5 cm - 5 3/4"
60.00.50

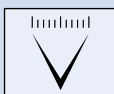

Messbereich
 Measuring range
 Alcance de medición
 Etendue de mesure
 Campo di misura



Zusätzliches Instrumentarium
Additional equipment
Instrumental adicional
Instruments supplémentaires
Strumentario aggiuntivo

C14

Kornzangen
Dressing forceps
Pinzas para curaciones
Pincas à pansements
Pinze per medicazione

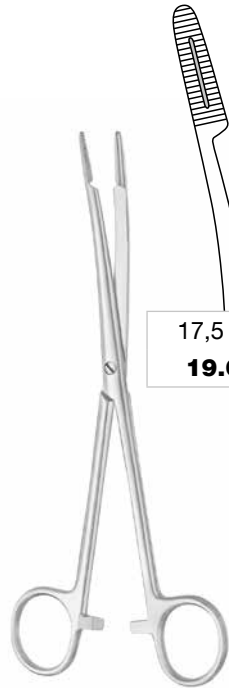

17,5 cm - 7"
19.09.17

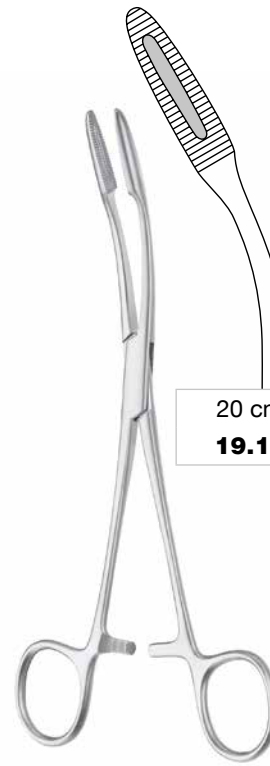

20 cm - 8"
19.17.20

Gross

Zungenspatel
Tongue spatula
Espátula bucal
Spatule buccale
Abbassalingua

18 mm



23 mm

18 cm - 7 1/8"
72.00.18

Buchwald

Tuchklemme
Towel clamp
Pinza de campo
Pince à champ
Pinza fissatele



13 cm - 5 1/8"
17.55.13

Backhaus



Mammoplastik
Mammoplasty
Mamoplastia
Plastie mammaire
Plastica mammaria

D

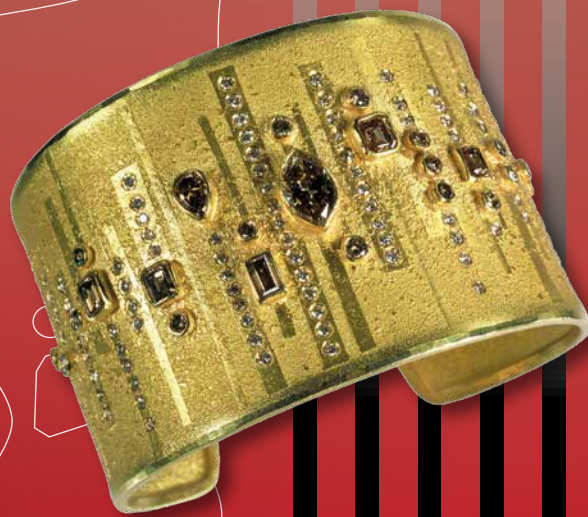

Z O B E L



D01

Brustdissektoren
Breast Dissectors
Disectores mamarios
Dissecteurs mammaires
Dissettori mammari

Atraumatische Brustdissektoren
 Atraumatic breast dissectors
 Disectores mamario atraumático
 Dissecteurs mammaire atraumatique
 Dissettori mammario atraumatico



Solz



34 cm - 13 ³ / ₈ "	24.90.10
37 cm - 14 ¹ / ₂ "	24.90.11



Brustdissektoren
Breast Dissectors
Disectores mamarios
Dissecteurs mammaires
Dissettori mammari

D01

Hakendisektoren
 Hook dissectors
 Disectores de gancho
 Dissecteurs crochet
 Dissettori a uncino

zur Feinkonturierung der
 Implantatlage

for fine contouring of the
 implant-bed

para contornear finamente
 el lecho para el implante

pour tracer avec précision
 les contours du lit d'implant

per la tracciatura precisa
 dei contorni dei solchi
 implantari

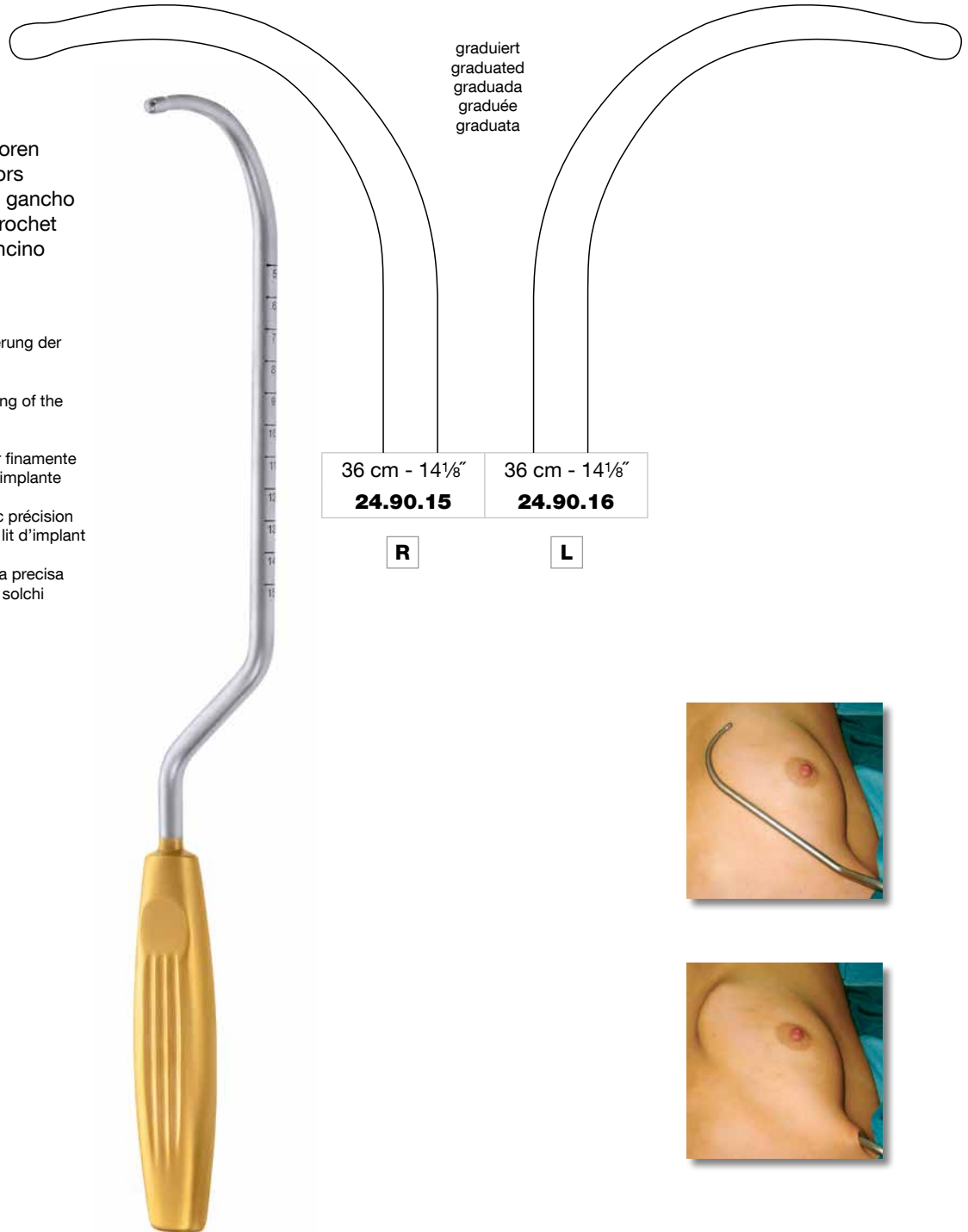

graduiert
 graduated
 graduada
 graduée
 graduata

36 cm - 14 1/8"

24.90.15

R

36 cm - 14 1/8"

24.90.16

L



Solz

L links
 left
 izquierdo
 gauche
 sinistro

R rechts
 right
 derecho
 droite
 destro

**D01**

Mamillenringe und Brustheber
Areola Marker and Breast Elevator
Marcadores para areola y elevador mamario
Marqueurs pour l'aréole et élévateur mammaire
Marcatori per areola e elevatore mammario

Mamillenringe (stumpf)
 Areola marker (blunt)
 Marcadores para areola (romos)
 Marqueurs pour l'aréole (moussé)
 Marcatori per areola (smussi)

**Solz**

Ø 36 mm	24.90.20
Ø 38 mm	24.90.23
Ø 40 mm	24.90.25
Ø 42 mm	24.90.30
Ø 45 mm	24.90.35

Für präzises Markieren der Brustwarze bei:
 - kombinierter Bruststraffung
 - Verkleinerung des Brustwarzenhofes

For precise marking of the nipple during:
 - combined Breast-Lifting
 - reduction of the areola

Para la marcación precisa del pezón en caso de:
 - combinación con un lifting de la mama
 - reducción del tamaño de la areola mamaria

Pour marquage exact du mamelon en cas de:
 - lifting des seins combiné
 - réduction de l'aréole

Per la marcatura esatta del capezzolo in caso di:
 - rassodamento combinato della mammella
 - riduzione del complesso areola-capezzolo

Schale für Markierungsfarbe
 Bowl for marking colour
 Cubeta para colorante de marcación
 Cupule pour couleur de marquage
 Scodella per colore di marcatura



60 x 30 mm (0,06 l)
47.31.02

Brustheber
 Breast elevator
 Elevador mamario
 Elévateur mammaire
 Elevatore mammario



28 cm - 11"
24.90.00



Brustretraktoren
Breast Retractors
Separadores mamarios
Ecarteurs mammaires
Divaricatori mammari

D02

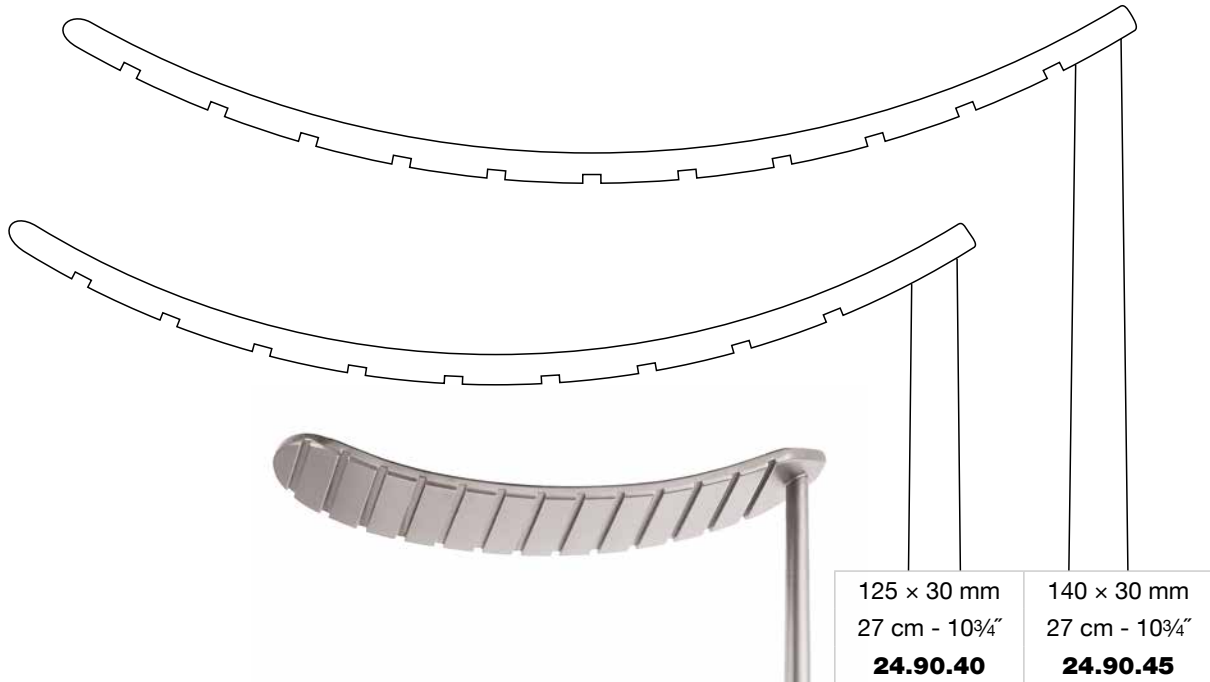

Zur übersichtlichen Präparation für alle brustchirurgischen Eingriffe, Axilladissektionen und für den Nachweis der sogenannten "Wächter-Lymphknoten".

This curved retractor is especially applicable to all types of breast surgeries, axilla dissections and for sentinel lymph node biopsies, allowing a clear preparation.

La lámina arqueada del separador es especialmente apta para todo tipo de operaciones mamarias, disecciones de la axila y biopsias del linfonodo sentinela, y permite una vista clara sobre el campo operatorio.

La valve courbe de l'écarteur a été spécialement conçue pour toutes les opérations mammaires, les dissections axillaires et biopsies de la sentinelle du nœuds de la gardien lymphatique, permettant aussi une excellente vue sur le champ opératoire.

La lama a curvatura convessa del divaricatore è particolarmente adatta alla preparazione di tutti i tipi di interventi chirurgici al seno, di dissezione ascellare e nella biopsia del cosiddetto linfonodo sentinella, poiché permette una chiara visione del campo operatorio.



Marx

www.medicon.de

Weitere MEDICON-Produkte finden Sie in
unserem Hauptkatalog

You will find further MEDICON products in our
main catalogue

Más productos de MEDICON se encuentra en nuestro
catálogo general

Vous trouverez d'autres produits MEDICON dans notre
catalogue général

Altri prodotti MEDICON si trovano nel nostro
catalogo generale



**Infiltration und Fettabsaugung
Infiltration and Liposuction
Infiltración y liposucción
Infiltration et liposuccion
Infiltrazione e liposuzione**

E



Z O B E L



Kanülen-Ansätze
Cannula Connectors
Empalmes de cánulas
Embouts des canules
Attacchi cannule

E01



Kanüle mit **Luer-Lock Ansatz** zum Anschluss an:

- z.B. Vakuum Glaszylinderspritze

Cannula with **Luer-Lock connection** for fixation to:

- e.g. vacuum glass-barrel syringe

Cánula con **empalme Luer-Lock** para la conexión con:

- p.ej. jeringa de vacío de vidrio

Canule avec **embout Luer-Lock** pour le raccordement:

- p. ex. à une seringue vacuum à cylindre en verre

Cannula con **attacco Luer-Lock** per il raccordo a:

- p.es. siringa in vetro sotto vuoto



Kanüle mit **Griffansatz** zum Anschluss an:

- Absaugpumpe mittels Handgriff
- Einmalspritze
- Adapter mit Luer-Lock Ansatz

Cannula with **handle connector** for fixation to:

- suction pump by handle
- disposable syringe
- adaptor with Luer-Lock connection

Cánula con **empalme mango** para conexión con:

- bomba de aspiración mediante el mango universal
- jeringa desechable
- adaptador con conexión Luer-Lock

Canules avec **embout-manche** pour le raccordement:

- à une pompe de succion à l'aide du manche
- à une seringue à usage unique
- adaptateur avec embout Luer-Lock

Cannula con **attacco-manico** per il collegamento alla:

- pompa d'aspirazione mediante il manico
- siringa monouso
- adattatore con attacco Luer-Lock

Mit Hilfe der roten Markierung am Griffansatz kann der Chirurg jederzeit die Positionierung der ersten bzw. zentralen Absaugöffnung der Kanüle vom distalen Ende aus erkennen.

By means of the red marking at the handle connector the surgeon is able to control at any time from its distal end the positioning of the first (central) suction hole of the cannula.

Mediante la marca roja en el empalme del mango el cirujano puede reconocer desde el final distal de la cánula el posicionamiento del primer orificio (central) en cada momento.

A l'aide de la marque rouge sur le embout du manche le chirurgien peut toujours apercevoir du bout distale la position du premier trou (trou central) de succion de la canule.

Il chirurgo può riconoscere la posizione del primo foro cioè del foro centrale della cannula dalla fine distale grazie alla rossa marcatura posizionata sul manico.

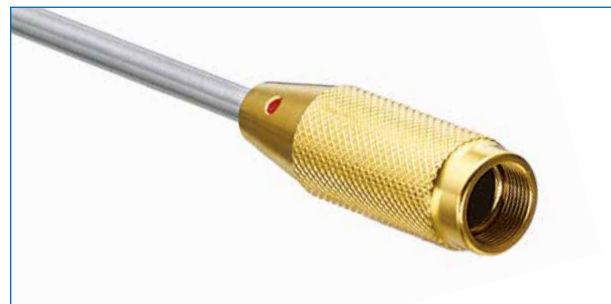

Roter Punkt oben = erste bzw. zentrale Absaugöffnung unten

Red point on top = first and central suction hole below

Punto rojo arriba = primer orificio (orificio central) de succión abajo

Puntino rosso en haut = premier trou (trou central) de succion en bas

Puntino rosso sopra = primo foro cioè foro d'aspirazione centrale sotto



Infiltration der Tumescenz-Lokalanästhesie-Lösung
Infiltration of the Tumescense Local Anaesthesia Solution
Infiltración de la solución de anestesia local tumescente
Infiltration de la solution de tumescence/anesthésie locale
Infiltrazione della soluzione d'anestesia locale tumescente

E02

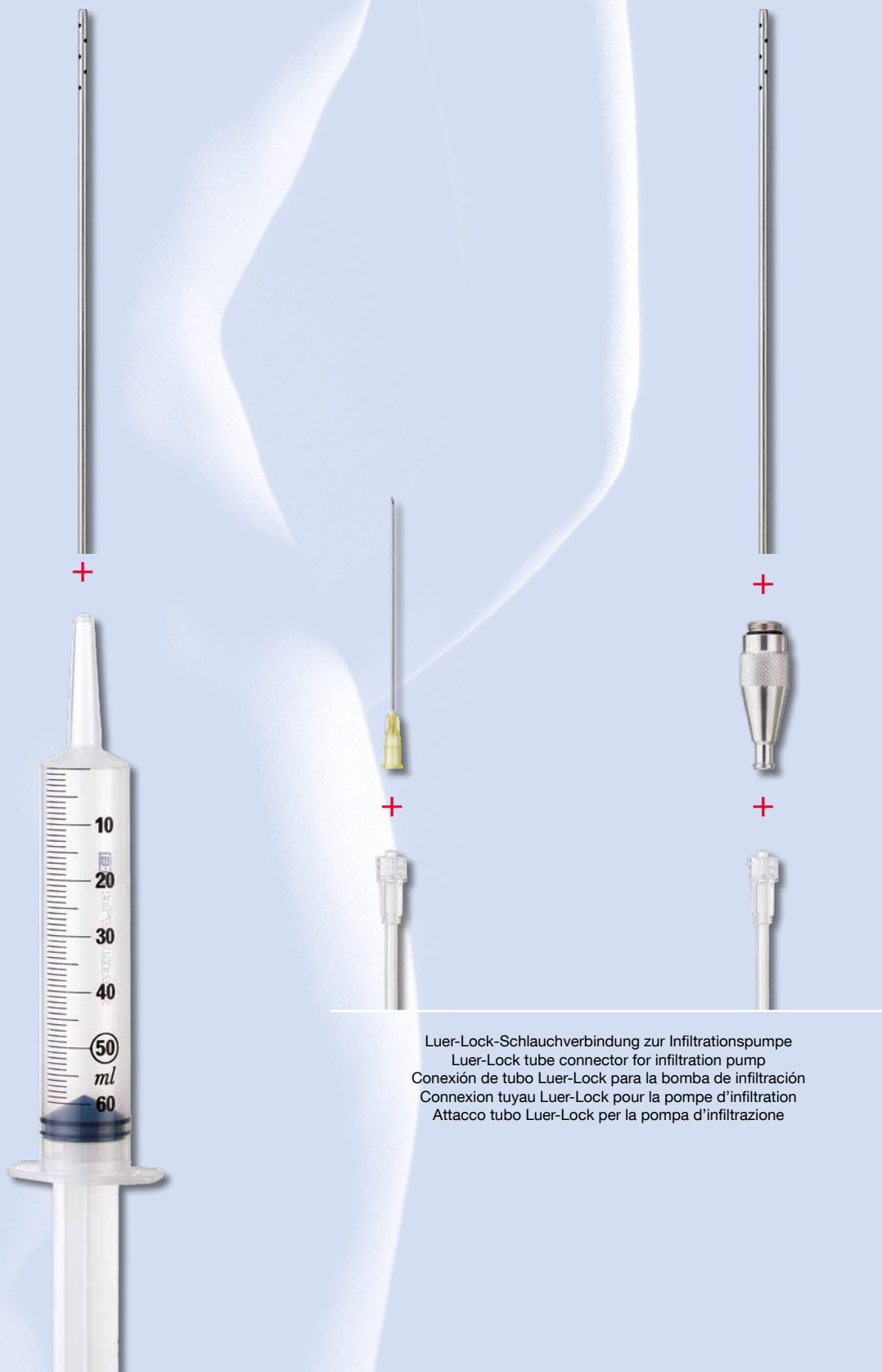

Luer-Lock-Schlauchverbindung zur Infiltrationspumpe
 Luer-Lock tube connector for infiltration pump
 Conexión de tubo Luer-Lock para la bomba de infiltración
 Connexion tuyau Luer-Lock pour la pompe d'infiltration
 Attacco tubo Luer-Lock per la pompa d'infiltrazione



Kanülen und Spritzen zur Infiltration
Cannulas and Syringes for Infiltration
Cánulas y jeringas de infiltración
Canules et seringues pour l'infiltration
Cannule e siringhe per infiltrazione

E02



	Ø 2,0 mm	Ø 3,0 mm	⊗ Single Use	Ø 1,0 mm	Ø 2,0 mm
		Ø 1,0 mm			⊗ 16
		Ø 1,5 mm		Ø 0,9 mm	Löcher Holes Orificios Trous Fori
				7 cm - 2¾"	
				09.88.05	
				P ₁₀₀	
				12 cm - 4¾"	
				09.88.06	
				P ₁₀₀	
					15 cm - 6"
					09.89.28
					Luer-Lock
					von Gregory



Adapter
 Adaptor
 Adaptador
 Adaptateur
 Adattatore



Luer-Lock

5 cm - 2"
09.87.85

Kunststoffspritze
 Plastic syringe
 Jeringa de plástico
 Seringue en matière plastique
 Siringa in materia plastica



50 / 60 ml
09.87.43
 P₆₀

⊗ Single Use

1:4

	Ø 15 mm 909.10.48 P ₁₀	Ersatzdichtung für Adapter Spare washers for adaptor Junta de repuesto para adaptador Joint de rechange pour adaptateur Guarnizione di ricambio per adattatore
--	--	--

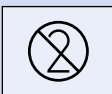

Einmalprodukt
 Single use product
 Prodotto para un solo uso
 Produit à usage unique
 Prodotto monouso

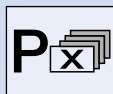

Verpackungseinheit "X" Stück, steril
 Packing unit "X" pieces, sterile
 Paquete de "X" unidades, estériles
 Emballage de "X" pièces, stériles
 Confezione da "X" pezzi, sterili

Maßangaben => Nutzlänge (Kanüle)
 Measurements => working length (cannula)
 Medidas => longitud útil (cánula)
 Mesures => longueur utile (canule)
 Misure => lunghezza utile (cannula)

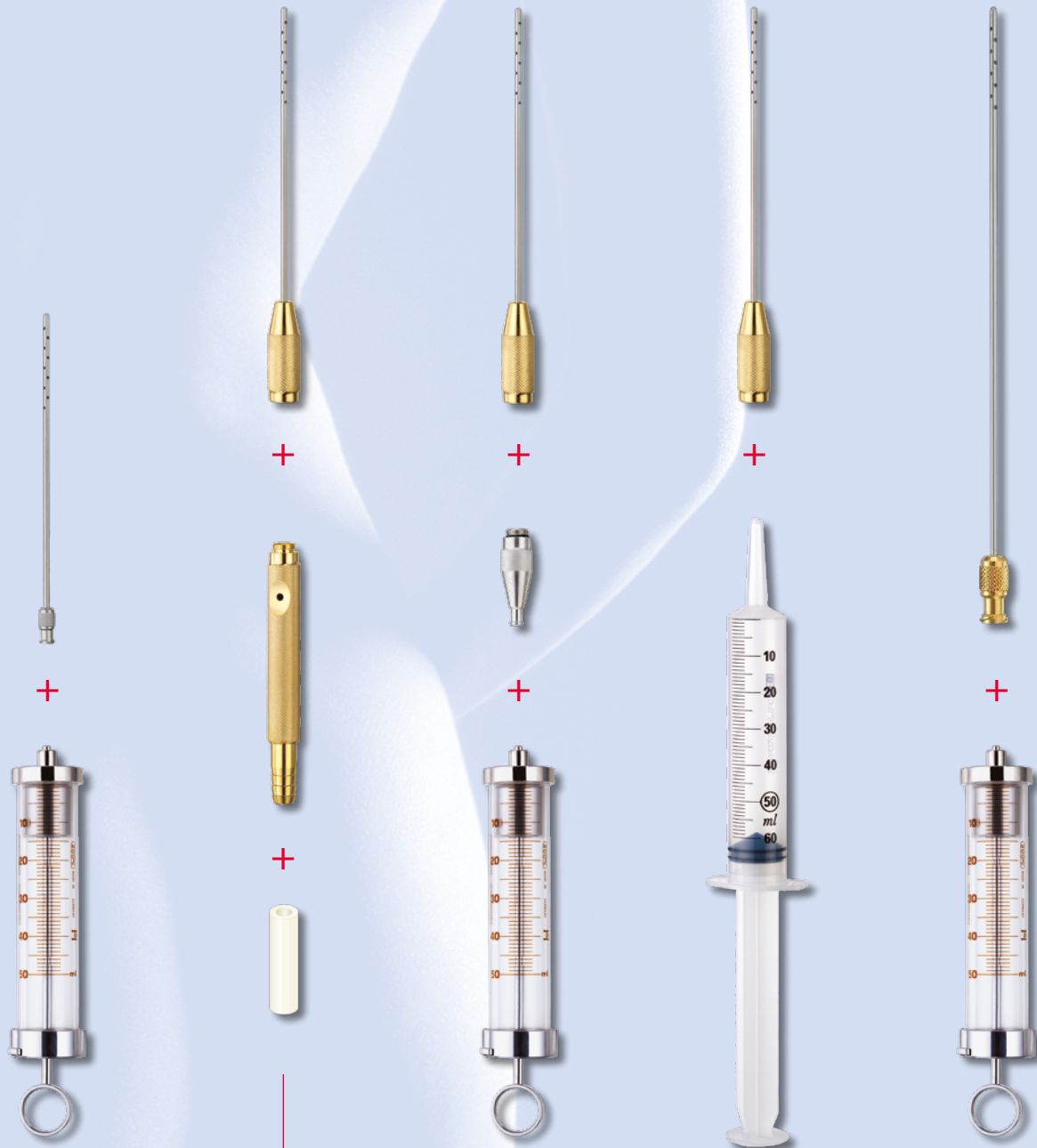

Schlauch zur Absaugpumpe
Tube for suction pump
Tubo para bomba de aspiración
Tuyau pour la pompe de succion
Tubo per pompa d'aspirazione



THE ART OF SURGERY

medicon®

Liposuction-Kanülen
Liposuction Cannulas
Cánulas de liposucción
Canules pour liposuction
Cannule per liposuzione

E03

15 cm - 6"	15 cm - 6"	20 cm - 8"	20 cm - 8"	30 cm - 11¾"	30 cm - 11¾"
09.87.60	09.87.61	09.87.62	09.87.64	09.87.65	09.87.66

Luer-Lock Ansatz
 Luer-Lock connection
 Empalme Luer-Lock
 Embout Luer-Lock
 Attacco Luer-Lock

15 cm - 6"	15 cm - 6"	20 cm - 8"	20 cm - 8"	30 cm - 11¾"	30 cm - 11¾"
09.87.70	09.87.71	09.87.72	09.87.74	09.87.75	09.87.76

Griffansatz
 Handle connector
 Empalme mango
 Embout-manche
 Attacco-manico

Entner

Maßangaben => Nutzlänge (Kanüle)
 Measurements => working length (cannula)
 Medidas => longitud útil (cánula)
 Mesures => longueur utile (canule)
 Misure => lunghezza utile (cannula)

212

Liposuction-Kanülen
Liposuction Cannulas
Cánulas de liposucción
Canules pour liposuction
Cannule per liposuzione

E03

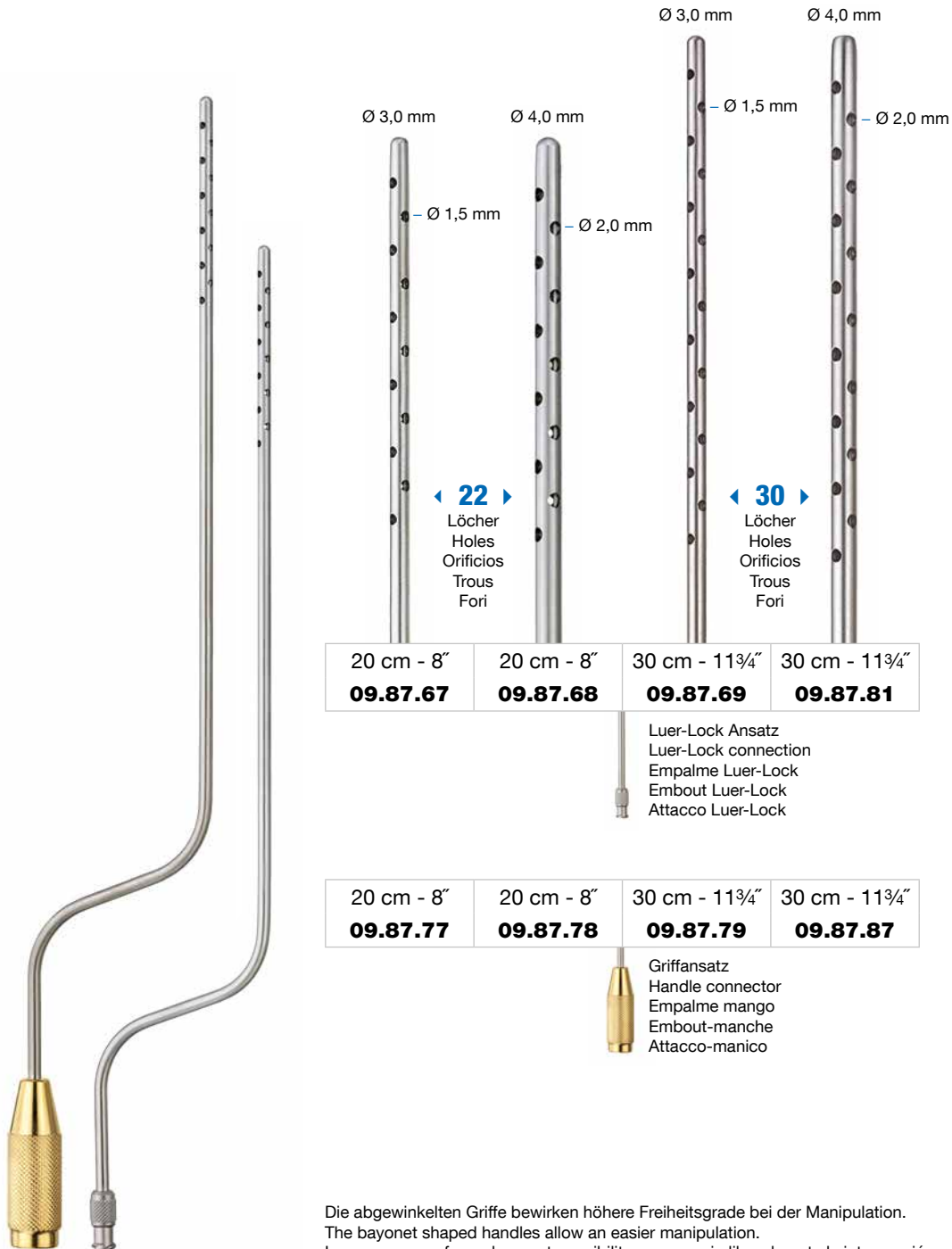

Entner

Die abgewinkelten Griffe bewirken höhere Freiheitsgrade bei der Manipulation.
 The bayonet shaped handles allow an easier manipulation.
 Los mangos en forma bayoneta posibilitan un manejo libre durante la intervención.
 Les manches en forme baïonnette accordent plus de liberté lors de la manipulation.
 I manici a forma di baionetta rendono possibile un maneggio libero durante l'intervento.

Maßangaben => Nutzlänge (Kanüle)
 Measurements => working length (cannula)
 Medidas => longitud útil (cánula)
 Mesures => longueur utile (canule)
 Misure => lunghezza utile (cannula)



Liposuction-Kanülen
Liposuction Cannulas
Cánulas de liposucción
Canules pour liposuction
Cannule per liposuzione

E03



Für feine Konturierungen im Gesichts- und Halsbereich.
For fine facial and neck contouring.
Para contornos finos de las partes faciales y del cuello.
Pour des contours fins dans la partie faciale et du cou.
Per contorni fini nella parte facciale e del collo.



Maßangaben => Nutzlänge (Kanüle)
Measurements => working length (cannula)
Medidas => longitud útil (cánula)
Mesures => longueur utile (canule)
Misure => lunghezza utile (cannula)

Setvorschläge Liposuction-Kanülen
Set Suggestions Liposuction Cannulas
Proposiciones de juegos de cánulas de liposucción
Propositions pour boîtes canules pour liposuction
Proposte set di cannule per liposuzione

E03

Hals
 Neck
 Cuello
 Cou
 Collo



5 cm Ø 2,0 mm 09.87.58	15 cm Ø 2,0 mm 09.87.48	15 cm Ø 3,0 mm 09.87.71	20 cm Ø 3,0 mm 09.87.73	15 cm Ø 2,0 mm 09.87.88
5 cm Ø 3,0 mm 09.87.59	15 cm Ø 3,0 mm 09.87.49			

Gesicht
 Face
 Cara
 Visage
 Viso



5 cm Ø 1,7 mm 09.87.57	6 cm Ø 1,5 mm 09.89.18	15 cm Ø 2,0 mm 09.87.70
-------------------------------------	-------------------------------------	--------------------------------------

Bauch und Reiterhosen
 Abdomen and saddlebag
 Abdomen y pantalones de montar
 Ventre et culotte de cheval
 Addome e coscia



20 cm Ø 3,0 mm 09.87.72	30 cm Ø 3,0 mm 09.87.75
20 cm Ø 4,0 mm 09.87.74	30 cm Ø 4,0 mm 09.87.76

Ober- und Unterschenkel
 Thigh- and lower leg
 Muslo y pantorrilla
 Cuisse et jambe
 Coscia e gamba



20 cm Ø 3,0 mm 09.87.77	30 cm Ø 3,0 mm 09.87.79
20 cm Ø 4,0 mm 09.87.78	30 cm Ø 4,0 mm 09.87.87

Zubehör (siehe Seite 222, 226)
 Accessories (see page 222, 226)
 Accesorios (véase página 222, 226)
 Accessoires (voyez page 222, 226)
 Accessori (vedete pagina 222, 226)



09.88.46



09.87.82



Liposuction-Kanülen
Liposuction Cannulas
Cánulas de liposucción
Canules pour liposuction
Cannule per liposuzione

E03

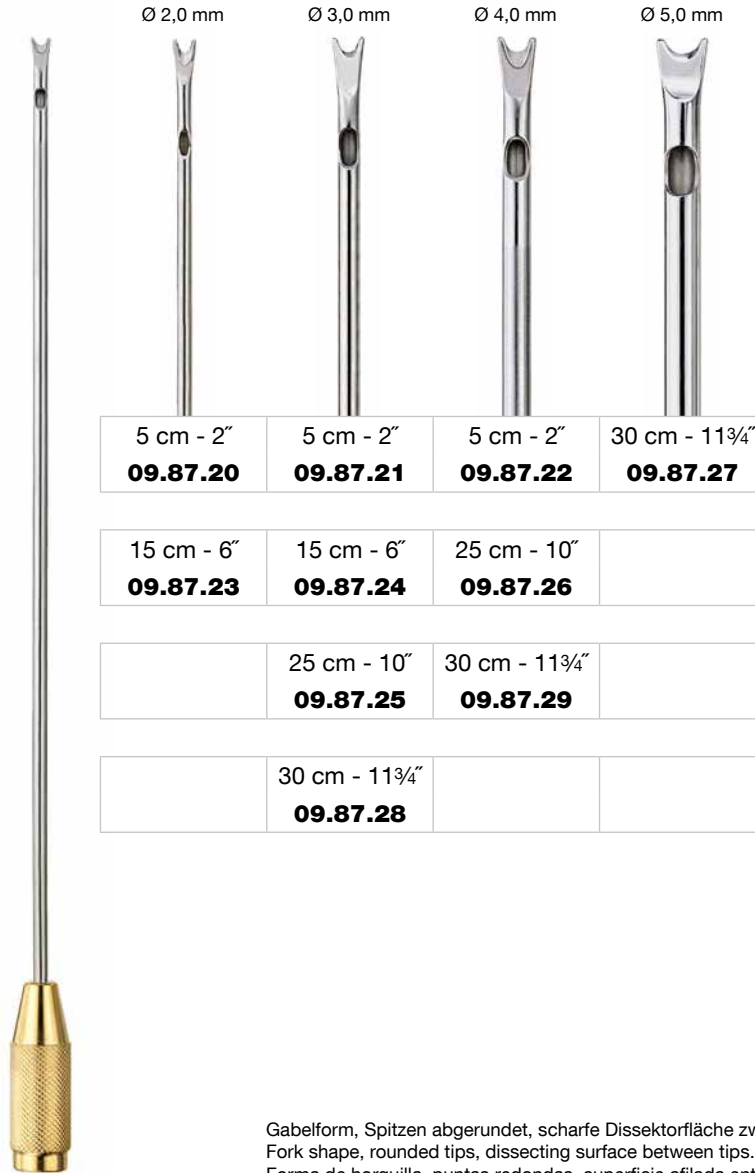
**Toledo**

Gabelform, Spitzen abgerundet, scharfe Dissektorfläche zwischen den Spitzen.
 Fork shape, rounded tips, dissecting surface between tips.
 Forma de horquilla, puntas redondas, superficie afilada entre las puntas.
 Forme de fourche, pointes arrondies, surface tranchante entre les pointes.
 A forma di forchetta, punte arrotondate, superficie affilata tra le punte.

ein zentrales Loch
 one central hole
 un orificio central
 un trou central
 un foro centrale

	Ø 2,0 mm	Ø 3,0 mm	Ø 4,0 mm	Ø 5,0 mm
	5 cm - 2" 09.87.20	5 cm - 2" 09.87.21	5 cm - 2" 09.87.22	30 cm - 11¾" 09.87.27
	15 cm - 6" 09.87.23	15 cm - 6" 09.87.24	25 cm - 10" 09.87.26	
		25 cm - 10" 09.87.25	30 cm - 11¾" 09.87.29	
		30 cm - 11¾" 09.87.28		

Liposuction-Kanülen
Liposuction Cannulas
Cánulas de liposucción
Canules pour liposuction
Cannule per liposuzione

E03

drei laterale Löcher
 three lateral holes
 tres orificios laterales
 trois trous latéraux
 tre fori laterali

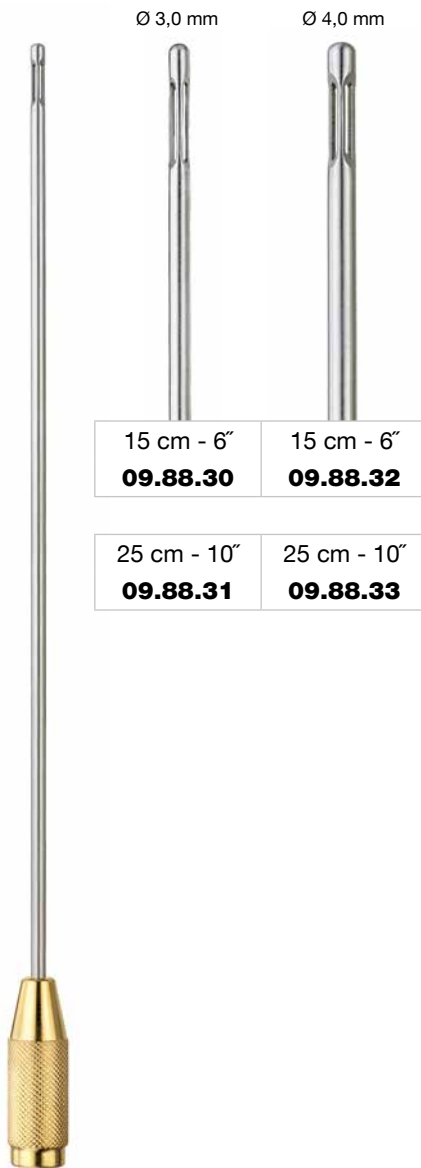

Ø 3,0 mm	Ø 4,0 mm
15 cm - 6"	15 cm - 6"
09.88.30	09.88.32
25 cm - 10"	25 cm - 10"
09.88.31	09.88.33

Mercedes

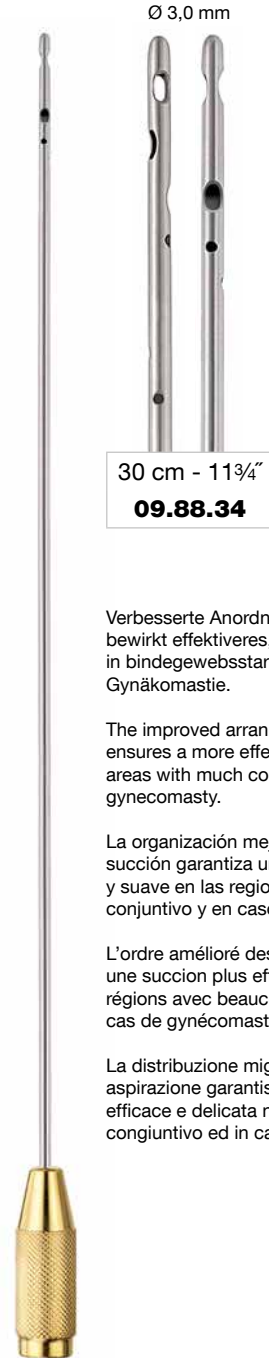

TURBO

◀ **9**
 Löcher
 Holes
 Orificios
 Troux
 Fori

30 cm - 11³/₄"
09.88.34

Kotzur

Verbesserte Anordnung der Sauglöcher bewirkt effektiveres, schonenderes Absaugen in bindegewebsstarken Regionen sowie bei Gynäkomastie.

The improved arrangement of the suction holes ensures a more effective and gentle suction in areas with much connective tissue and in case of gynecomasty.

La organización mejorada de los agujeros de succión garantiza una succión más efectiva y suave en las regiones con mucho tejido conjuntivo y en caso de ginecomastia.

L'ordre amélioré des trous à succion garantit une succion plus efficace et plus douce dans les régions avec beaucoup de tissu conjonctif et en cas de gynécomastie.

La distribuzione migliorata dei buchi di aspirazione garantisce un'aspirazione più efficace e delicata nelle zone con molto tessuto congiuntivo ed in caso di ginecomastia.

THE ART OF SURGERY

medicon®

Liposuction-Kanülen
Liposuction Cannulas
Cánulas de liposucción
Canules pour liposuction
Cannule per liposuzione

E03

A

ein zentrales Loch
zwei laterale Löcher

one central hole
two lateral holes

un orificio central
dos orificios laterales

un trou central
deux trous latéraux

un foro centrale
due fori laterali

B

zwei laterale Löcher
ein zentrales Loch

two lateral holes
one central hole

dos orificios laterales
un orificio central

deux trous latéraux
un trou central

due fori laterali
un foro centrale

Ø 3,0 mm

Ø 4,0 mm

Ø 5,0 mm

Ø 6,0 mm

20 cm - 8" 09.87.00	30 cm - 11¼" 09.87.02	30 cm - 11¼" 09.87.03	30 cm - 11¼" 09.87.04
30 cm - 11¼" 09.87.01			

Ø 3,0 mm

Ø 4,0 mm

Ø 5,0 mm

Ø 6,0 mm

20 cm - 8" 09.87.14	30 cm - 11¼" 09.87.16	30 cm - 11¼" 09.87.17	30 cm - 11¼" 09.87.19
30 cm - 11¼" 09.87.15			

Maßangaben => Nutzlänge (Kanüle)
 Measurements => working length (cannula)
 Medidas => longitud útil (cánula)
 Mesures => longueur utile (canule)
 Misure => lunghezza utile (cannula)

218

Liposuction-Kanülen
Liposuction Cannulas
Cánulas de liposucción
Canules pour liposuction
Cannule per liposuzione

E03

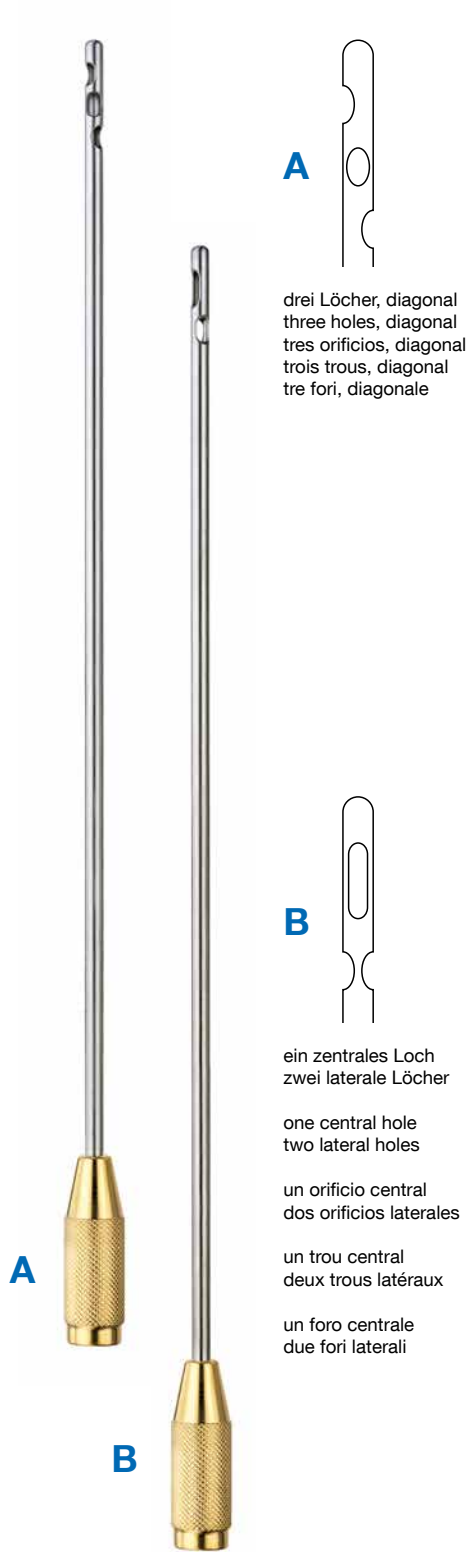

A



drei Löcher, diagonal
 three holes, diagonal
 tres orificios, diagonal
 trois trous, diagonal
 tre fori, diagonale

B



ein zentrales Loch
 zwei laterale Löcher

one central hole
 two lateral holes

un orificio central
 dos orificios laterales

un trou central
 deux trous latéraux

un foro centrale
 due fori laterali

Ø 3,0 mm

Ø 4,0 mm

Ø 5,0 mm

Ø 6,0 mm



20 cm - 8"
09.87.07

30 cm - 11¾"
09.87.09

30 cm - 11¾"
09.87.10

30 cm - 11¾"
09.87.11

30 cm - 11¾"
09.87.08

40 cm - 15¾"
09.87.12

Ø 4,0 mm

Ø 5,0 mm



30 cm - 11¾"
09.87.33

30 cm - 11¾"
09.87.34

Maßangaben => Nutzlänge (Kanüle)
 Measurements => working length (cannula)
 Medidas => longitud útil (cánula)
 Mesures => longueur utile (canule)
 Misure => lunghezza utile (cannula)



Liposuction-Kanülen
Liposuction Cannulas
Cánulas de liposucción
Canules pour liposuction
Cannule per liposuzione

E03



Spitze mit Loch
Point with hole
Punta con orificio
Pointe à trou
Punta con foro

Ø 3,0 mm



ein zentrales Loch
one central hole
un orificio central
un trou central
un foro centrale



20 cm - 8"
09.87.37

30 cm - 11¾"
09.87.38

6,0 mm



30 cm - 11¾"
09.87.40

35 cm - 13¾"
09.87.41

Maßangaben => Nutzlänge (Kanüle)
Measurements => working length (cannula)
Medidas => longitud útil (cánula)
Mesures => longueur utile (canule)
Misure => lunghezza utile (cannula)

Liposuction-Kanülen
Liposuction Cannulas
Cánulas de liposucción
Canules pour liposuction
Cannule per liposuzione

E03

Für feine Konturierungen im Gesichtsbereich
 For fine facial contours
 Para contornos finos de la parte facial
 Pour des contours fins dans la partie faciale
 Per un contorno nelle parti facciali

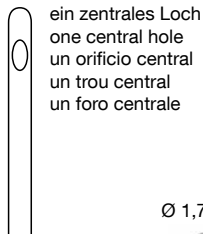

	Ø 1,7 mm	Ø 2,0 mm	Ø 3,0 mm	Ø 1,7 mm	Ø 2,0 mm	Ø 3,0 mm
	5 cm - 2"	5 cm - 2"	5 cm - 2"	15 cm - 6"	15 cm - 6"	15 cm - 6"
	09.87.57	09.87.58	09.87.59	09.87.47	09.87.48	09.87.49
				Luer-Lock Ansatz Luer-Lock connection Empalme Luer-Lock Embout Luer-Lock Attacco Luer-Lock		
	5 cm - 2"	5 cm - 2"	5 cm - 2"	15 cm - 6"	15 cm - 6"	15 cm - 6"
	09.87.50	09.87.51	09.87.52	09.87.53	09.87.54	09.87.55
				Griffansatz Handle connector Empalme mango Embout-manche Attacco-manico		

Maßangaben => Nutzlänge (Kanüle)
 Measurements => working length (cannula)
 Medidas => longitud útil (cánula)
 Mesures => longueur utile (canule)
 Misura => lunghezza utile (cannula)



Handgriffe für Kanülen
Handles for Cannulas
Mangos para cánulas
Manches pour canules
Manici per cannule

E03



13 cm - 5 1/8"
09.87.45



13 cm - 5 1/8"
09.88.45



Schlauchansatz, drehbar
Tube connection, rotatable
Empalme de tubo, giratorio
Embout de tuyau, pivotant
Attacco per il tubo, girevole



13 cm - 5 1/8"
09.87.46



13 cm - 5 1/8"
09.88.46



Anschlussgewinde für Kanülen
Connection thread for cannulas
Rosca para cánulas
Filetage pour canules
Filettatura per cannule



Loch zur Saugunterbrechung
Hole for interrupting the suction process
Orificio para interrumpir la succión
Trou afin d'interrompre la succión
Foro per bloccare l'aspirazione

Schlauchansatz
Tube connection
Empalme de tubo
Embout de tuyaux
Attacco per tubo

Ø 13 mm

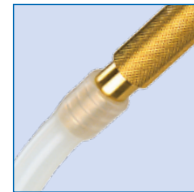

Empfohlene Handgriffe für die Tumescenz-Lokalanästhesie-Technik
Recommended handles for the tumescence local anaesthesia technique
Mangos recomendados para la técnica de la anestesia local tumescente
Manches recommandés pour la technique de tumescence/anesthésie locale
Manici consigliati per la tecnica anestesia locale tumescente

Kanülen zur Eigenfettunterspritzung
Cannulas for Lipoinjection
Cánulas para lipoinyección
Canules pour injection d'auto-grasse
Cannule per iniezione del grasso autologo



Für feine Konturierungen im Gesichtsbereich
 For fine facial contours
 Para contornos finos de la parte facial
 Pour des contours fins dans la partie faciale
 Per un contorno nelle parti facciali

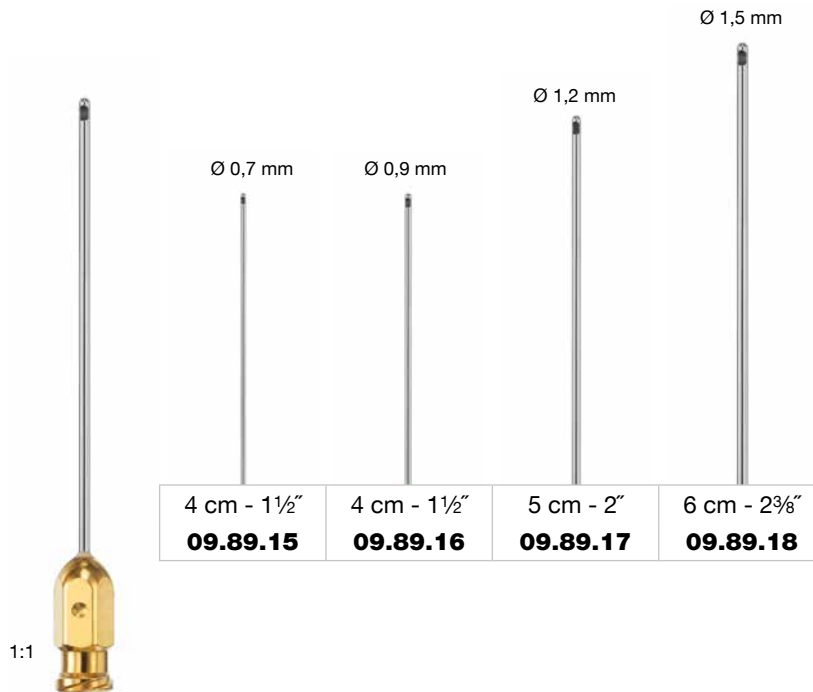



E04

Kanülen zur Eigenfettentnahme
Cannulas for Autologous Fat Transfer
Cánulas para extracción de grasa autóloga
Canules pour le prélèvement de graisse autologue
Cannule per l'asportazione del grasso



Ø 1,5 mm

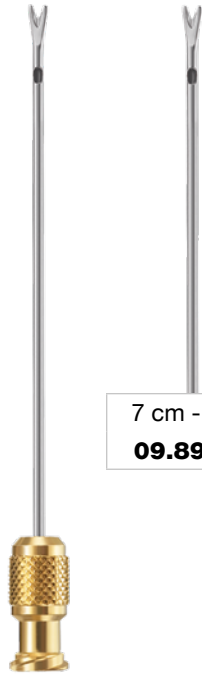

ein zentrales Loch
 one central hole
 un orificio central
 un trou central
 un foro centrale

7 cm - 2¾"
09.89.22

1:1

Toledo

Gabelform, Spitzen abgerundet, scharfe Dissektorfläche zwischen den Spitzen.
 Fork shape, rounded tips, dissecting surface between tips.
 Forma de horquilla, puntas redondas, superficie afilada entre las puntas.
 Forme de fourche, pointes arrondies, surface tranchante entre les pointes.
 A forma di forchetta, punte arrotondate, superficie affilata tra le punte.

Ø 2,5 mm



4
 Löcher
 Holes
 Orificios
 Trous
 Fori

15 cm - 6"
09.89.24

1:1

von Gregory

Maßangaben => Nutzlänge (Kanüle)
 Measurements => working length (cannula)
 Medidas => longitud útil (cánula)
 Mesures => longueur utile (canule)
 Misure => lunghezza utile (cannula)

Kanülen zur Eigenfettentnahme
Cannulas for Autologous Fat Transfer
Cánulas para extracción de grasa autóloga
Canules pour le prélèvement de graisse autologue
Cannule per l'asportazione del grasso

E04

Ø 3,0 mm



18 cm - 7 1/8"
09.89.26



1,3 mm Lochdurchmesser
 1,3 mm hole diameter
 1,3 mm diametro d'orificios
 1,3 mm diamètre des trous
 1,3 mm diametro dei fori

Ø 2,0 mm



15 cm - 6"
09.89.28

◀ **16**

Löcher
 Holes
 Orificios
 Trous
 Fori

Auch besonders geeignet zur subdermalen Saug-Kürettage bei axillärer Hyperhidrosis.
 Particularly suitable for Subdermal Suction Curettage in Case of Axillary Hyperhidrosis.
 Especialmente adecuado para curetaje y succión subdermal en caso de hiperhidrosi axilar.
 Convient en particulier pour le curetage et la suction subdermal en cas de hyperhidrose axillaire.
 Particolarmente adatto per il curettage e l'aspirazione sottodermica in caso di iperidrosi ascellare

1:1

von Gregory

1:1

von Gregory

Maßangaben => Nutzlänge (Kanüle)
 Measurements => working length (cannula)
 Medidas => longitud útil (cánula)
 Mesures => longueur utile (canule)
 Misure => lunghezza utile (cannula)



scharf
 sharp
 afilada
 tranchante
 affilata



Spritzen und Zubehör
Syringes and Accessories
Jeringas y accesorios
Seringues et accessoires
Siringhe e accessori

E05

Kunststoffspritze
 Plastic syringe
 Jeringa de plástico
 Seringue en matière plastique
 Siringa in materia plastica



50 (60) ml
09.87.43

P₆₀

1:4

⊗ Single Use

Spritzenstopp aus Aluminium
 Aluminium stop (lock) for syringes
 Stop de aluminio para jeringas
 Stoppeur en aluminium pour seringues
 Bloccaggio della siringa in alluminio



13 cm - 5 1/8"
09.87.44

Zur Gewinnung eines Vakuums in der Spritze
 For establishing a vacuum in the syringe
 Para obtener un vacío dentro de la jeringa
 Pour d'obtenir un vacuum dans la seringue
 Per ottenere un vuoto nella siringa

Vakuum-Glaszylinderspritze
 Vacuum glass-barrel syringe
 Jeringa de vacío de vidrio
 Seringue vacuum à cylindre en verre
 Siringa in vetro sotto vuoto

Luer-Lock



50 ml
09.87.82

Stop 25/50 ml

1:4



Adapter
 Adaptor
 Adaptador
 Adaptateur
 Adattatore



Luer-Lock

5 cm - 2"
09.87.85

50 ml
09.78.47

Ersatzzylinder
 Spare barrel
 Cilindro de repuesto
 Cylindre de rechange
 Cilindro di ricambio



Ø 15 mm
909.10.48
 P₁₀

Ersatzdichtung für Adapter
 Spare washers for adaptor
 Junta de repuesto para adaptador
 Joint de rechange pour adaptateur
 Guarnizione di ricambio per adattatore



Einmalprodukt
 Single use product
 Producto para un solo uso
 Produit à usage unique
 Prodotto monouso

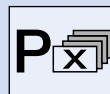

Verpackungseinheit "X" Stück, steril
 Packing unit "X" pieces, sterile
 Paquete de "X" unidades, estériles
 Emballage de "X" pièces, stériles
 Confezione da "X" pezzi, sterili

Eigenfettunterspritzung
Lipoinjection
Lipoinyección
Lipofilling – injection d’auto-graisse
Lipofilling – iniezione del grasso autologo

E06



Lipo-Transfer nach der manuellen Fettabsaugung
 Lipotransfer after manual liposuction
 Lipotransferencia después de la liposucción manual
 Lipo-transfert après la liposuction manuelle
 Trasferimento del proprio grasso dopo la liposuzione manuale

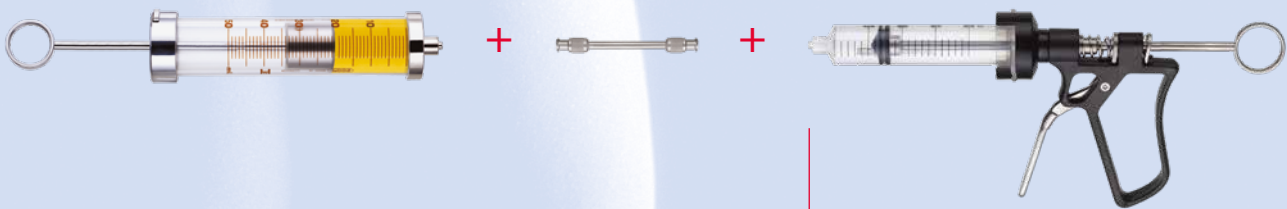

**E06**

Instrumente zur Eigenfettunterspritzung
Instruments for Lipoinjection
Instrumentos para lipoinyección
Instrumentes pour le lipofilling
Strumenti per lipofilling

Vakuüm-Glaszylinderspritzen
 Vacuum glass-barrel syringes
 Jeringas de vacío de vidrio
 Seringues vacuum à cylindre en verre
 Siringhe in vetro sotto vuoto



Luer-Lock



10 ml
09.87.80

10 ml
09.78.44
 Ersatzzylinder
 Spare barrel
 Cilindro de repuesto
 Cylindre de rechange
 Cilindro di ricambio

Luer-Lock



50 ml
09.87.82

Stop 25/50 ml

50 ml
09.78.47
 Ersatzzylinder
 Spare barrel
 Cilindro de repuesto
 Cylindre de rechange
 Cilindro di ricambio

Spritzenständer
 Holding device for syringes
 Soporte para jeringas
 Support pour seringues
 Supporto per siringhe

Luer-Lock



Ø 40 mm
09.87.86

Für eine gesicherte Lagerung von Luer-Lock Spritzen mit abgesaugtem Fett
 For a safe storage of Luer-Lock syringes containing ejected deposits
 Para un almacenamiento seguro de las jeringas Luer-Lock llenas de grasa aspirada
 Pour un stockage sûr des seringues Luer-Lock contenant des lipides enlevés en suçant
 Per un magazzino sicuro delle siringhe Luer-Lock con il grasso aspirato



Instrumente zur Eigenfettunterspritzung
Instruments for Lipoinjection
Instrumentos para la lipoinyección
Instruments pour le lipofilling
Strumenti per lipofilling

E06

Transfer-Adapter für Luer-Lock Spritzen
 Transfer adaptor for Luer-Lock syringes
 Adaptador de transferencia para jeringas Luer-Lock
 Adaptateur de transfert pour seringues Luer-Lock
 Adattatore di trasferimento per siringhe Luer-Lock

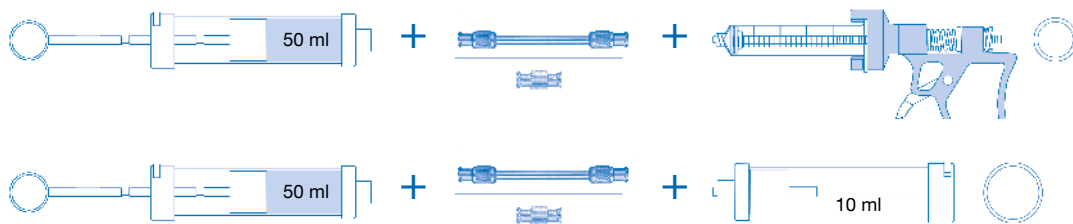
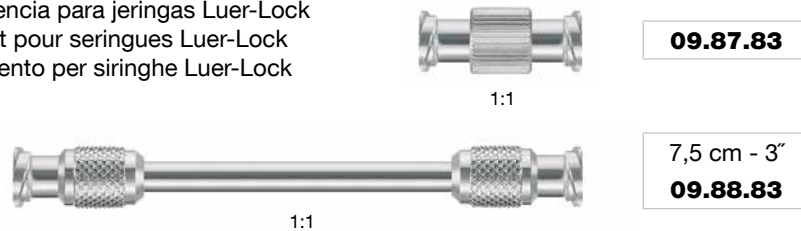

Lipo-Injektion-Dosierhandgriffe
 Lipoinjection dosage handles
 Mangos para dosificar la lipoinyección
 Manches à doser le lipofilling
 Manici per dosare il lipofilling



für 20 ml Spritze for 20 ml syringe para jeringa 20 ml pour seringue 20 ml per siringa 20 ml 09.87.90	für 1 ml Spritze for 1 ml syringe para jeringa 1 ml pour seringue 1 ml per siringa 1 ml 09.87.93	für 3 ml Spritze for 3 ml syringe para jeringa 3 ml pour seringue 3 ml per siringa 3 ml 09.87.95
---	--	--





Instrumente zur Eigenfettunterspritzung
Instruments for Lipoinjection
Instrumentos para la lipoinyección
Instrumentes pour le lipofilling
Strumenti per lipofilling

E06

Kunststoffspritzen
 Plastic syringes
 Jeringas de plástico
 Seringues en matière plastique
 Siringhe in materia plastica

⊗ Single Use

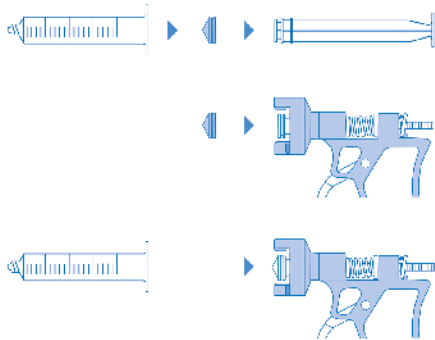

Luer-Lock



3 ml
09.87.98
 P₂₀₀

1 ml
09.87.94
 P₁₀₀

Luer-Lock



20 ml
09.87.92
 P₁₂₀

Injektionskanülen
 Hypodermic needles
 Cánulas de inyección
 Canules d'injection
 Cannule per iniezione



1:1

⊗ Single Use

Luer-Lock

Ø 1,2 mm

Ø 2,0 mm

Ø 1,2 mm

Ø 2,0 mm

4 cm - 1½"

09.88.01
 P₁₀₀

4 cm - 1½"

09.88.03
 P₁₀₀

6 cm - 2¾"

09.88.02
 P₁₀₀

6 cm - 2¾"

09.88.04
 P₁₀₀



Einmalprodukt
 Single use product
 Producto para un solo uso
 Produit à usage unique
 Prodotto monouso

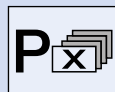

Verpackungseinheit "X" Stück, steril
 Packing unit "X" pieces, sterile
 Paquete de "X" unidades, estériles
 Emballage de "X" pièces, stériles
 Confezione da "X" pezzi, sterili

Maßangaben => Nutzlänge (Kanüle)
 Measurements => working length (cannula)
 Medidas => longitud útil (cánula)
 Mesures => longueur utile (canule)
 Misure => lunghezza utile (cannula)

Subdermale Saug-Kürettage bei axillärer Hyperhidrosis
Subdermal Suction Curettage for Axillary Hyperhidrosis
Curetaje y succión subdermal en caso de hiperhidrosis axilar
Curetage et la succion subdermal en cas de hyperhidrose axillaire
Curettagge e aspirazione sottodermica in caso di iperidrosi ascellare

E07

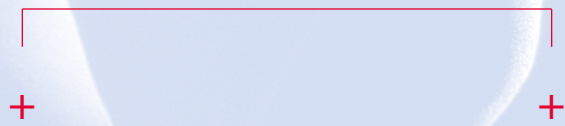

+



Schlauch zur Absaugpumpe
 Tube for suction pump
 Tubo para bomba de aspiración
 Tuyau pour la pompe de succion
 Tubo per pompa d'aspirazione





Instrumente zur subdermalen Saug-Kürettage bei axillärer Hyperhidrosis
Instruments for Subdermal Suction Curettage for Axillary Hyperhidrosis
Instrumentos para curetaje y succión subdermal en caso de hiperhidrosis axilar
Instrumentes pour le curetage et la succión subdermal en cas de hyperhidrose axillaire
Strumenti per il curettage e l'aspirazione sottodermica in caso di iperidrosi ascellare

E07



Dorow

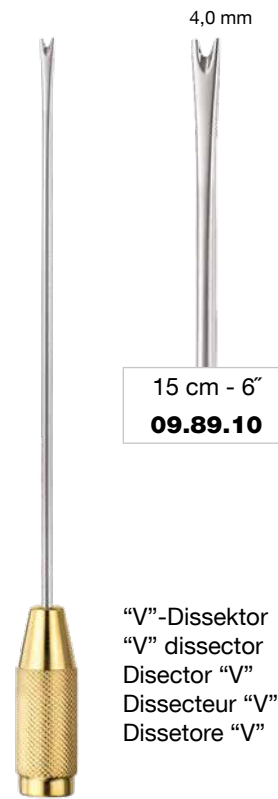

Dorow

Instrumente zur subdermalen Saug-Kürettage bei axillärer Hyperhidrosis
Instruments for Subdermal Suction Curettage in Case of Axillary Hyperhidrosis
Instrumentos para curetaje y succión subdermal en caso de hiperhidrosi axilar
Instruments pour le curetage et la succion subdermal en cas de hyperhidrose axillaire
Strumenti per il curettage e l'aspirazione sottodermica in caso di iperidrosi ascellare

E07



Kunststoffspritze
 Plastic syringe
 Jeringa de plástico
 Seringue en matière plastique
 Siringa in materia plastica

Single Use

50 (60) ml

09.87.43

P

1:4



Handgriff (siehe Seite 222)
 Handle (see page 222)
 Mango (véase página 222)
 Manche (voyez page 222)
 Manico (vedete pagina 222)

13 cm - 5 1/8"

09.88.46

360°

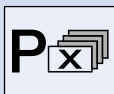

Verpackungseinheit "X" Stück, steril
 Packing unit "X" pieces, sterile
 Paquete de "X" unidades, estériles
 Emballage de "X" pièces, stériles
 Confezione da "X" pezzi, sterili

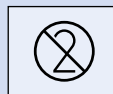

Einmalprodukt
 Single use product
 Producto para un solo uso
 Produit à usage unique
 Prodotto monouso

**E08**

Infiltrationspumpe für die Liposuction
Infiltration Pump for Liposuction
Bomba de infiltración para la liposucción
Pompe d'infiltration pour la liposuction
Pompa d'infiltrazione per la liposuzione

LS-i 30

INFILTRATION



Besonders geeignet für die Injektion der
Tumesenzlösung für die Liposuktion.

Particularly suitable for the injection of tumescent
solution during liposuction procedures.

Especialmente apto para la inyección de la solución
tumescente para la liposucción.

Particulièrement approprié pour l'injection de la
solution d'infiltration pour la liposuction.

Specialmente adatta all'iniezione della soluzione
tumescente per la liposuzione.

Spannung (umschaltbar)
Voltage (switchable)
Voltaje (conmutable)
Tension (réglable)
Tensione (commutabile)

Pumpenleistung
Pumpage
Rendimiento de la bomba
Puissance de la pompe
Potenza della pompa

Gewicht netto
Net weight
Peso neto
Poids net
Peso netto

LS-i 30 INFILTRATION

100/115/230 V / 50 – 60 Hz

1 – 15 l/h

2,4 kg

LS-i 30 Infiltration komplett:
complete:
completo:
complet:
completo:

91.70.30

91.70.32
26 x 25 x 10 cm

1

Steuergerät 100/115/230 V / 50-60 Hz
Control unit 100/115/230 V / 50-60 Hz
Unidad de control 100/115/230 V / 50-60 Hz
Unité centrale 100/115/230 V / 50-60 Hz
Unità di comando 100/115/230 V / 50-60 Hz

**91.70.31**

1

ON/OFF - Pedal
ON/OFF - Pedal
Pedal - ON/OFF
Pédale - ON/OFF
Pedale - ON/OFF

**91.70.23**

1

Flaschenhalter
Jar holder
Porta botellas
Porte-bocaux
Portavasi

Zubehör
Accessories
Accesorios
Accessoires
Accessori

91.70.03

Schlauchset, einweg, steril
Set of disposable tubes, single use, sterile
Juego de tubos, desechable, estéril
Jeu de tuyaux, usage unique, stérile
Set di tubi, mono uso, sterile

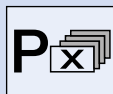

Verpackungseinheit "X" Stück, steril
Packing unit "X" pieces, sterile
Paquete de "X" unidades, estériles
Emballage de "X" pièces, stériles
Confezione da "X" pezzi, sterili



**Abdominoplastik
Abdominoplasty
Abdominoplastia
Abdominoplastie
Addominoplastica**

F



Z O B E L

**F01**

Bauchretractor für die Lipoabdominoplastik
Abdominal Retractor for Lipoabdominoplasty
Separador abdominal para la lipoabdominoplastia
Ecarteur abdominal pour la plastie lipo-abdominale
Divaricatore addominale per la lipoaddominoplastica

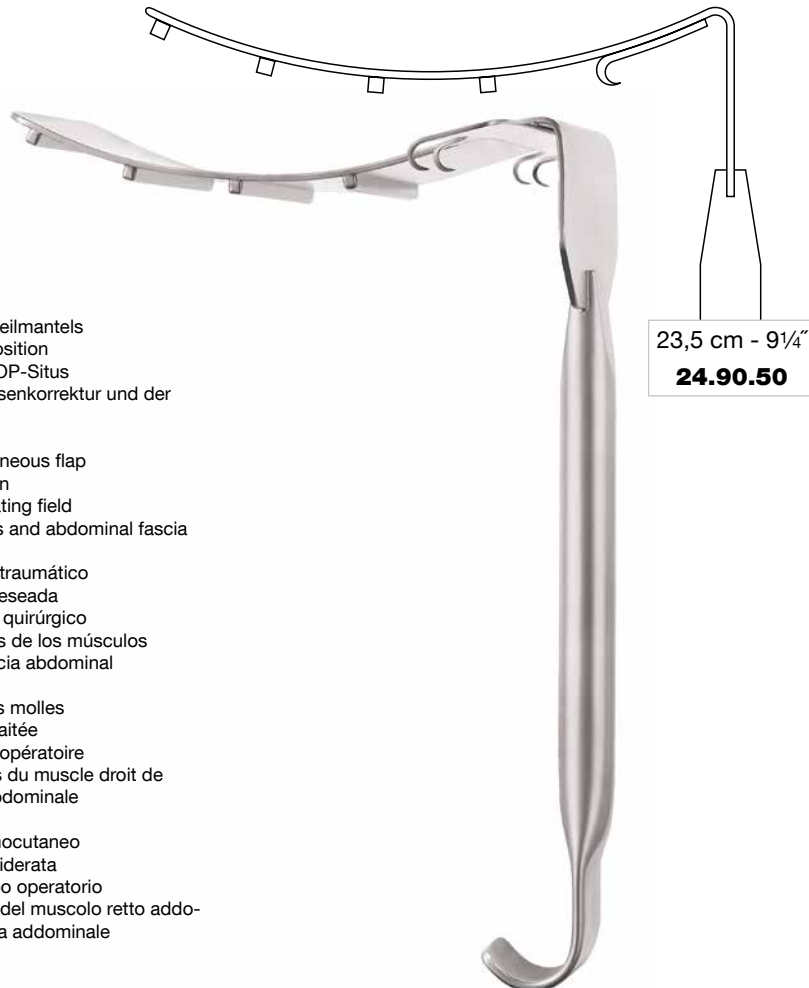
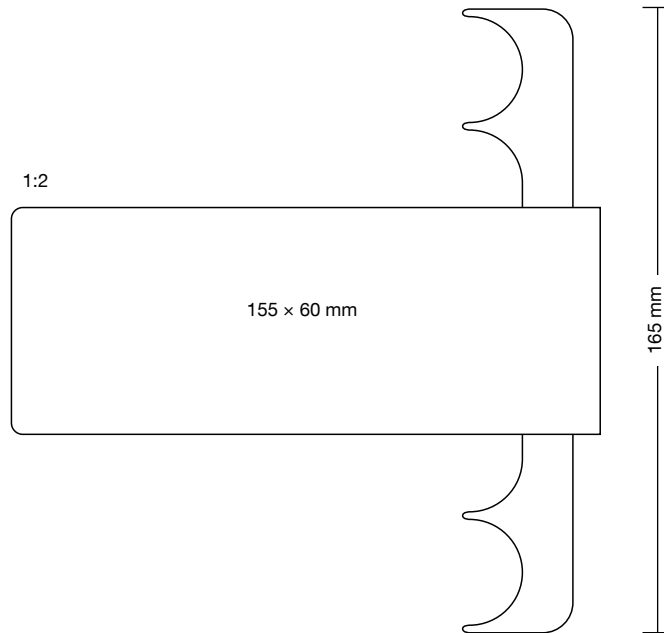

- ▶ Atraumatische Hebung des Weichteilmantels
- ▶ Gute Stabilität in der benötigten Position
- ▶ Ausgezeichnete Präsentation des OP-Situs
- ▶ Erleichterung bei der Rektusdiastasenkorrektur und der Bauchfasziendoppelung

- ▶ Atraumatic lifting of the dermocutaneous flap
- ▶ High stability of the desired position
- ▶ Excellent presentation of the operating field
- ▶ Facilitates repair of rectus diastasis and abdominal fascia

- ▶ Lifting del colgajo dermocutaneo atraumático
- ▶ Buena estabilidad de la posición deseada
- ▶ Presentación excelente del campo quirúrgico
- ▶ Facilita la corrección de la diástasis de los músculos del recto y de la plicatura de la fascia abdominal

- ▶ Lifting non traumatisant des parties molles
- ▶ Bonne stabilité de la position souhaitée
- ▶ Excellente présentation du champ opératoire
- ▶ Facilite la correction de la diastasis du muscle droit de l'abdomen et des plis de la face abdominale

- ▶ Lifting atraumatico del lembo dermocutaneo
- ▶ Buona stabilità della posizione desiderata
- ▶ Presentazione eccellente del campo operatorio
- ▶ Facilita la correzione della diastasi del muscolo retto addominale e della piegatura della fascia addominale

Saldanha-Solz

Bauchnabelpositionierer
Navel Marker
Posicionador de ombligo
Positionneur du nombril
Posizionatore dell'ombelico

F01

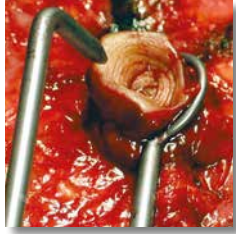

- ▶ Exakte Positionierung des Bauchnabels entsprechend der ursprünglichen Lage
- ▶ Sicheres Auffinden der Nabelposition auf der Bauchhaut nach der Raffung
- ▶ Ausreichende Spannweite für dickere Bauchdecken
- ▶ Exact re-positioning of the navel in correspondance to the original position
- ▶ Secure tracing of the navel position on the abdominal skin after lightening procedures
- ▶ Sufficient span length also for thicker abdomen
- ▶ Reposicionamiento exacto del ombligo según su posición original
- ▶ Seguridad en localizar la posición del ombligo después del lifting del abdomen
- ▶ Apertura suficientemente grande, también para abdómenes excesivos
- ▶ Repositionnement exact du nombril conforme à la position originale
- ▶ Identification sûre de la position du nombril sur la paroi abdominale après le lifting
- ▶ Ouverture également suffisante pour des parois abdominales plus épaisses
- ▶ Riposizionamento dell'ombelico conforme alla sua posizione originale
- ▶ Ritrovamento sicuro della posizione dell'ombelico sulla parete addominale dopo la tensione
- ▶ Apertura abbastanza larga anche per addomi più grossi

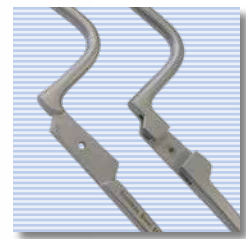
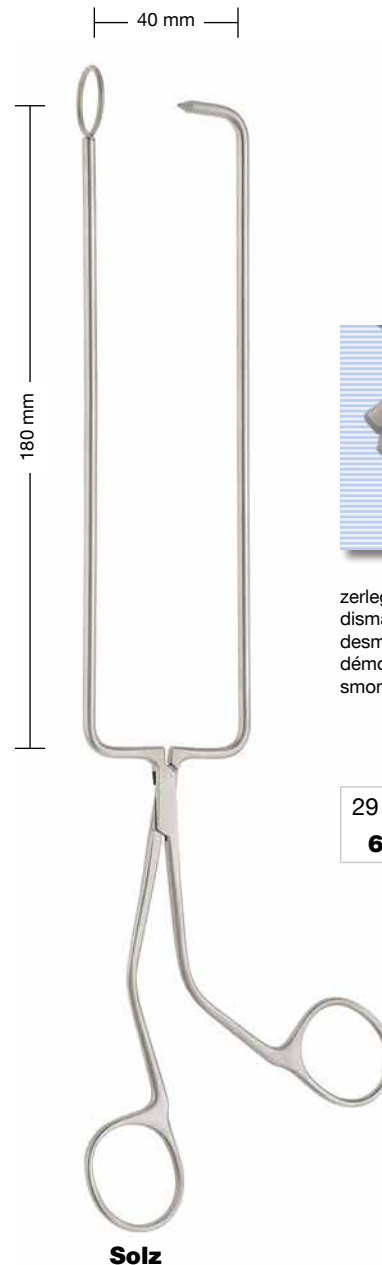

zerlegbar
 dismantable
 desmontable
 démontable
 smontabile

29 cm - 11³/₈"
67.93.29

www.medicon.de



**Blepharoplastik
Blepharoplasty
Blefaroplastia
Blépharoplastie
Blefaroplastica**

G



Z O B E L



Instrumente für die Blepharoplastik
Instruments for Blepharoplasty
Instrumentos para la blefaroplastia
Instrumentos pour la blépharoplastie
Strumenti per la blefaroplastica

GUBISCH



- ▶ Feine Wundhaken mit Isolierungsschicht
- ▶ Isolierungsschicht verhindert Kontakt zwischen HF-Nadel und Wundhaken
- ▶ Vermeiden von Gewebeschädigungen durch punktuelle Hitzeentwicklung
- ▶ Gubisch Blepharopinzette:
Spezielle Biegung ermöglicht punktuell Fassen des Gewebes

- ▶ Fine retractors with insulation layer
- ▶ Insulation layer prevents contact between HF-needle and retractor
- ▶ Avoiding tissue damages caused by punctual heat development
- ▶ Gubisch Blepharoplasty forceps:
Special bending permits punctual tissue grabbing

- ▶ Separadores finos con aislamiento
- ▶ El recubrimiento del aislamiento evita el contacto entre la aguja de alta frecuencia y el separador
- ▶ Impedimiento del traumatismo de tejido por el desarrollo de calor puntual
- ▶ Gubisch pinza para blefaroplastia:
Gracias al doblamiento especial el agarre de tejido puntual es posible

- ▶ Ecarteurs fins avec revêtement isolant
- ▶ Le revêtement isolant empêche tout contact entre l'aiguille HF et l'écarteur
- ▶ Permet d'éviter qu'un développement ponctuel de chaleur n'endommage les tissus
- ▶ Gubisch pince de blépharoplastie :
sa courbure spéciale permet de saisir le tissu de manière ponctuelle

- ▶ Divaricatori fini con strato isolante
- ▶ Lo strato isolante impedisce il contatto tra l'ago ad alta frequenza e il divaricatore
- ▶ Evita danni ai tessuti causati dal calore locale
- ▶ Gubisch pinza per blefaroplastica:
La curvatura speciale rende possibile la presa precisa del tessuto

Feine Wundhaken mit Isolierungsschicht
 Delicate retractors with insulation layer
 Separadores finos con aislamiento
 Ecarteurs fins avec revêtement isolant
 Divaricatori delicati con strato isolante

- VORTEILE**
 - ▶ Verhindert Kontakt zwischen HF-Nadel und Wundhaken
 - ▶ Vermeidet Gewebeschädigungen durch punktuelle Hitzeentwicklung
- AVANTAGES**
 - ▶ Prevents contact between HF-needle and retractor
 - ▶ Avoids tissue damages caused by punctual heat development
- VENTAJAS**
 - ▶ Evita el contacto entre la aguja de alta frecuencia y el separador
 - ▶ Impide del traumatismo de tejido por el desarrollo de calor puntual
- AVANTAGES**
 - ▶ Empêche tout contact entre l'aiguille HF et l'écarteur
 - ▶ Evite le développement ponctuel de chaleur n'endommage les tissus
- VANTAGGI**
 - ▶ Impedisce il contatto tra l'ago ad alta frequenza e il divaricatore
 - ▶ Evita danni ai tessuti causati dal calore locale



Fomon



Desmarres

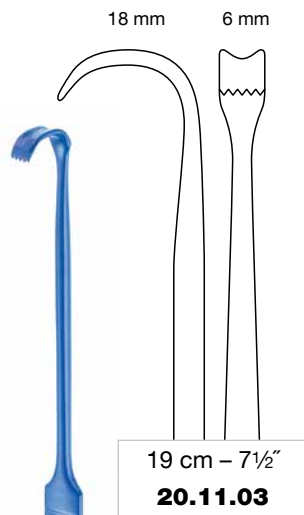

Strandell-Style

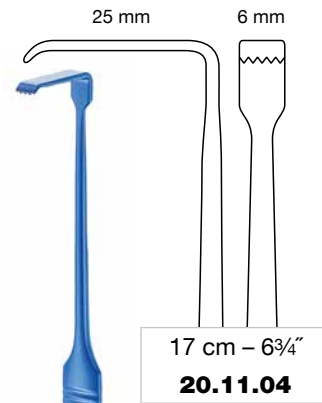

Langenbeck-Green



**G01**

Instrumente für die Blepharoplastik
Instruments for Blepharoplasty
Instrumentos para la blefaroplastia
Instrumentos pour la blépharoplastie
Strumenti per la blefaroplastica

Messzirkel
 Caliper
 Compás
 Compas
 Compasso

**Castroviejo**

Blefaropinzette
 Blepharoplasty forceps
 Pinza para blefaroplastia
 Pince de blépharoplastie
 Pinza per blefaroplastica

Spezielle Biegung ermöglicht punktuellles Fassen des Gewebes
 Special bending permits punctual tissue grabbing
 Gracias al doblamiento especial el agarre de tejido puntual es posible
 Sa courbure spéciale permet de saisir le tissu de manière ponctuelle
 La curvatura speciale rende possibile la presa precisa del tessuto

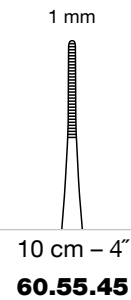
**Gubisch**

Endoskopisches Facelifting
Endoscopic Facelift
Lifting facial endoscópico
Lifting facial endoscopique
Lifting facciale endoscopico

H

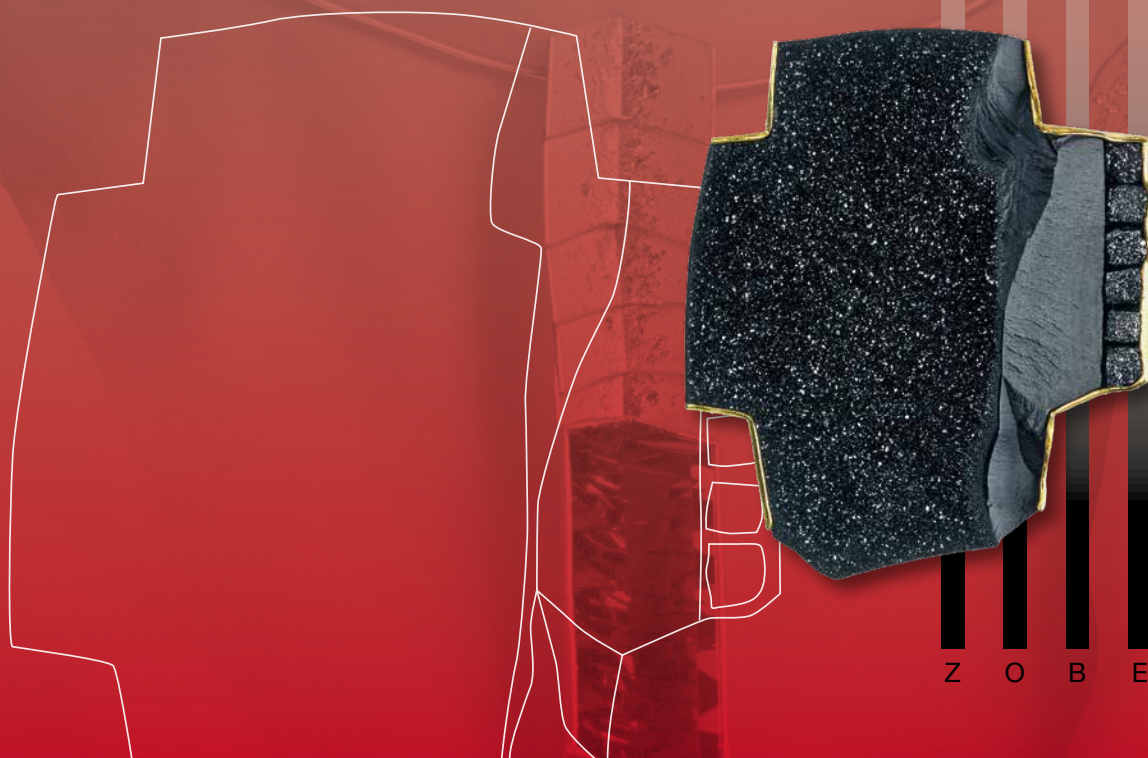

Z O B E L



Raspatorien
Raspatories
Legras
Rugines
Periostotomi

H01



25 cm - 10" **67.70.03** 25 cm - 10" **67.70.05**

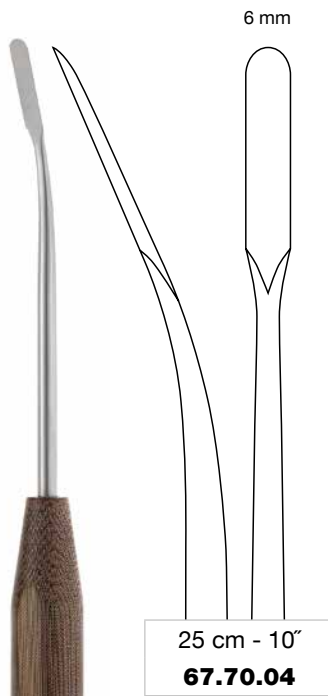

25 cm - 10" **67.70.04**

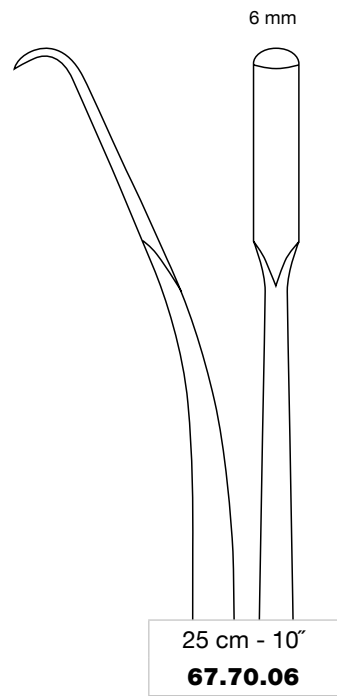

25 cm - 10" **67.70.06**

Dissektor
Dissector
Disector
Dissecteur
Dissettore

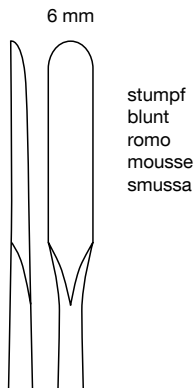

25 cm - 10" **67.70.08**

stumpf
blunt
romo
mousse
smussa

Dissektor
Dissector
Disector
Dissecteur
Dissettore



25 cm - 10" **67.70.09**

stumpf
blunt
romo
mousse
smussa



Kunststoffgriff (autoklavierbar bis 134 °C bei 3 bar)
Plastic handle (autoclavable up to 134 °C at 3 bar)
Mango de plástico (autoclavable hasta 134 °C bajo presión de 3 bar)
Manche en plastique (autoclavable à 134 °C sous pression de 3 bars)
Manico di plastica (autoclavabile fino a 134 °C sotto pressione di 3 bar)

**Dissektoren, Elevatorium
Dissectors, Elevator
Disectores, Elevador
Dissecteurs, Elévateur
Dissettori, Elevatore**

H01



27,5 cm - 10³/₄"
67.70.45

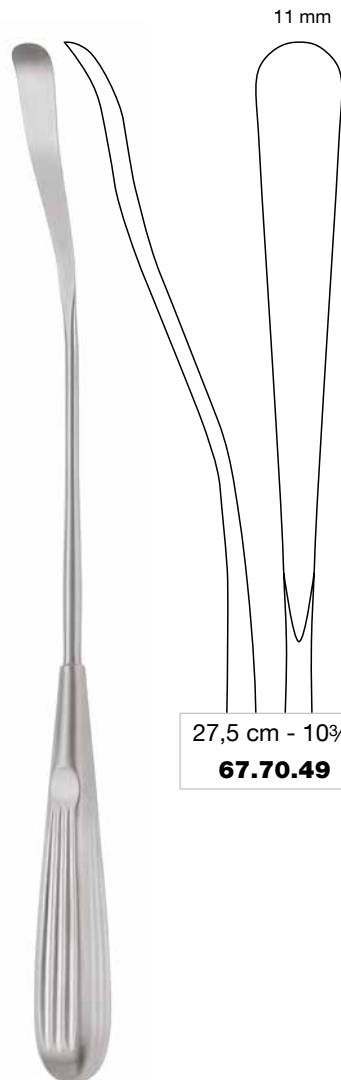

27,5 cm - 10³/₄"
67.70.49

Elevatorium
Elevator
Elevador
Elévateur
Elevatore

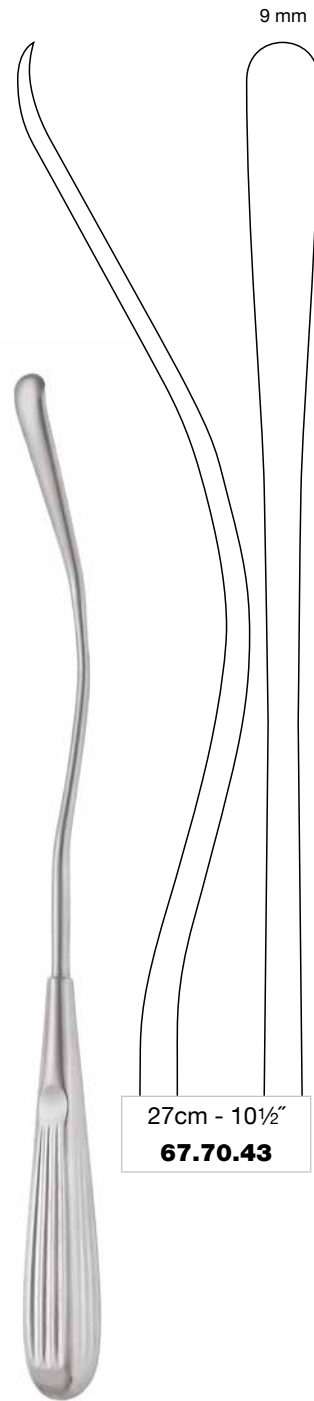

27cm - 10¹/₂"
67.70.43



H01

Nervhäkchen und Fadenführungsadeln
Nerve Hooks and Ligature Needles
Ganchitos para nervios y agujas para ligaduras
Crochets à nerfs et aiguilles à ligature
Uncini per nervi e aghi per legatura

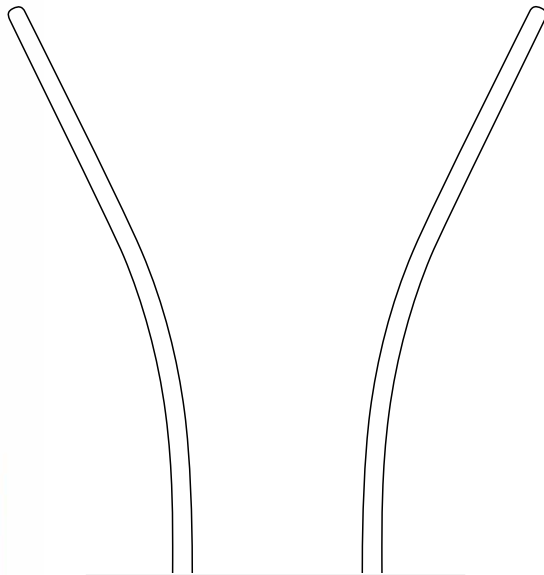
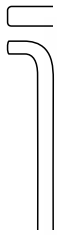

20 cm - 8"	20 cm - 8"
67.70.11	67.70.12

Fadenführungsadeln
 Ligature needles
 Agujas para ligaduras
 Aiguilles à ligature
 Aghi per legatura

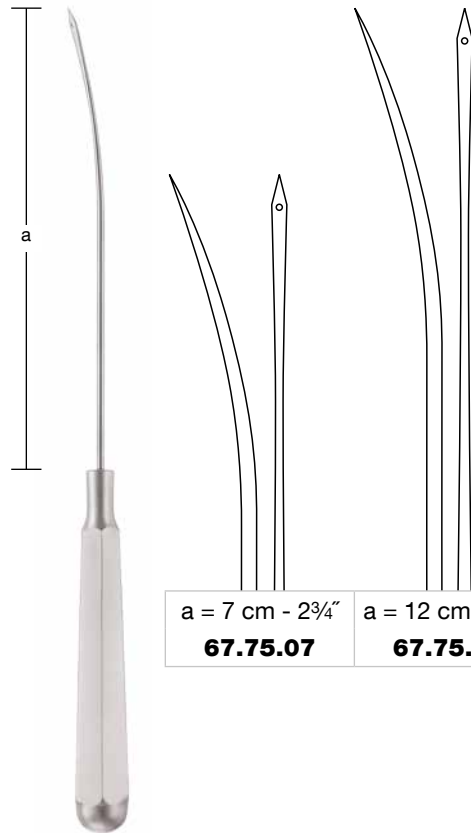

Entner

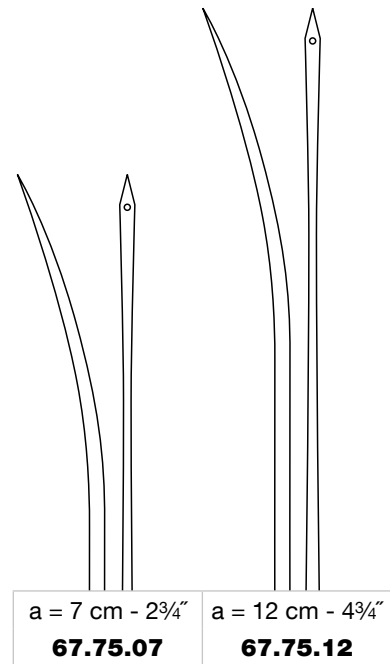

Fasszangen und Hakenscheren
Grasping Forceps and Hook Scissors
Pinzas para agarrar y tijeras de gancho
Pinces à saisir et ciseaux à crochet
Pinze per afferrare e forbici ad uncino

H02

Hakenscheren
 Hook scissors
 Tijeras de gancho
 Ciseaux à crochet
 Forbici ad uncino

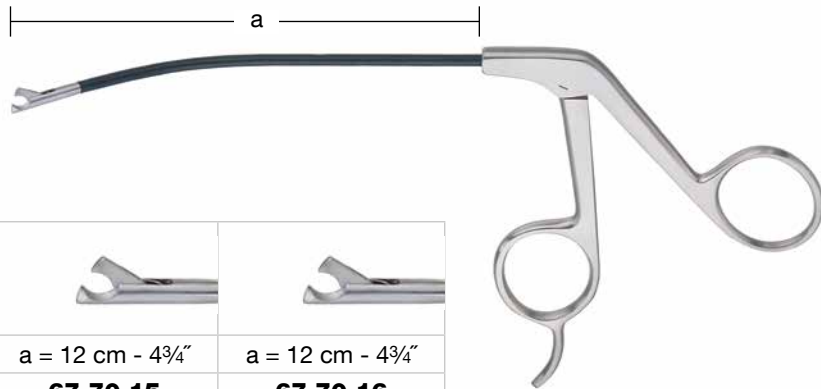

	a = 12 cm - 4 ³ / ₄ "	a = 12 cm - 4 ³ / ₄ "
	67.70.15	67.70.16
	links gebogen curved left curva izquierdo courbes à gauche curva sinistra	rechts gebogen curved right curva derecho courbés à droite curva destra

Fasszangen
 Grasping forceps
 Pinzas para agarrar
 Pinces à saisir
 Pinze per afferrare

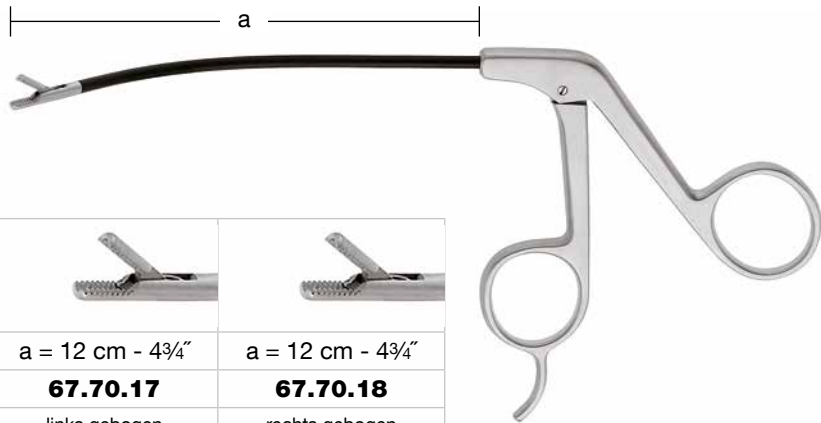

	a = 12 cm - 4 ³ / ₄ "	a = 12 cm - 4 ³ / ₄ "
	67.70.17	67.70.18
	links gebogen curved left curva izquierdo courbes à gauche curva sinistra	rechts gebogen curved right curva derecho courbés à droite curva destra



H02

Endoskope und Endoskop-Führung
Endoscopes and Endoscope Guide
Endoscopios y guía para endoscopios
Endoscopes et guide pour endoscopes
Endoscopi e guida per endoscopi

inklusive Adapter zum Anschluß für Lichtleitkabel
 including adapter for connection to fibre optic cable
 con adaptador para la conexión del cable conductor de luz
 avec adaptateur pour la connexion du câble conducteur de lumière
 compreso adattatore per l'attacco di cavo conduttore di luce

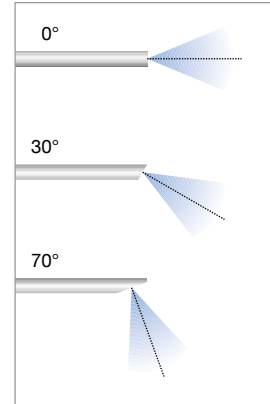
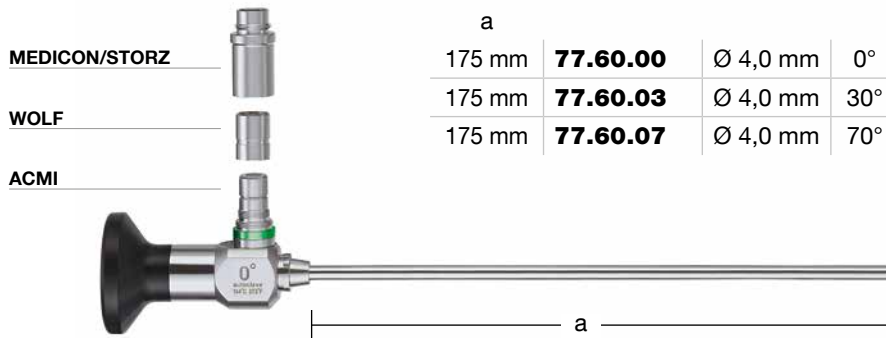

Tray für Endoskope (siehe Seite 272)
 Tray for endoscopes (see page 272)
 Bandeja para endoscopios (véase página 272)
 Cassette pour endoscopes (voyez page 272)
 Cassetta per endoscopi (vedete pagine 272)

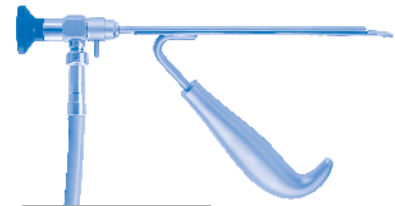

Lichtleitkabel
 Fibre optic cable
 Cable conductor de luz
 Câble conducteur de lumière
 Cavo conduttore di luce

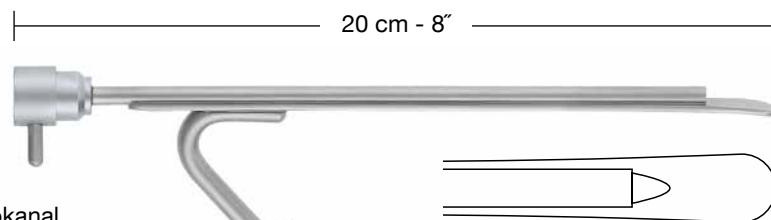

Retraktor mit Endoskopkanal
 Retractor with channel for endoscope
 Separador con canal para endoscopio
 Ecarteur avec canal pour endoscope
 Divaricatore con canale per endoscopio

12 cm - 4 3/4" **67.70.01**

für Endoskope **77.60.00**
 for endoscopes **77.60.03**
 para endoscopios **77.60.07**
 pour endoscopes
 per endoscopi



**Ohrmuschelplastik
Auricular Plastic
Otoplastia
Otoplastie
Otoplastica**

J



Z O B E L



Instrumente für die Ohrmuschelplastik
Instruments for Auricular Plastic
Instrumentos para la otoplastia
Instrumentos pour l'otoplastie
Strumenti per l'otoplastica

J01



Modelliermesser
Sculpture knives
Cuchillos para modelar
Couteaux à modeler
Coltelli per modellare

Messer
Knives
Cuchillos
Couteaux
Coltelli

Griffe
Handles
Mangos
Manches
Manici



Nagata

12 cm - 4³/₄"
01.97.01

3,0 mm



8 cm - 3¹/₈"
01.97.04

4,5 mm

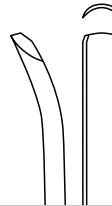

8 cm - 3¹/₈"
01.97.05

6,0 mm

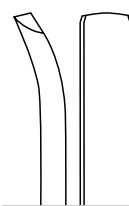

8,5 cm - 3³/₈"
01.97.06



Nagata

12 cm - 4³/₄"
01.97.02

Drahtspannzange
Wire twisting forceps
Pinza tensora de alambre
Pince serre-fil
Pinza tendifili d'acciaio



Niro "HM"

15 cm - 6"
14.40.65

"HM"

Hartmetall
Tungsten carbide
Carburo de tungsteno
Carbure de tungstène
Carburo di tungsteno

Instrumente für die Ohrmuschelplastik
Instruments for Auricular Plastic
Instrumentos para la otoplastia
Instrumentos pour l'otoplastie
Strumenti per l'otoplastica

J01

Drahtschere
 Wire cutting scissors
 Tijera para cortar alambre
 Ciseaux coupe-fil
 Forbice per fili d'acciaio



Universal "HM"

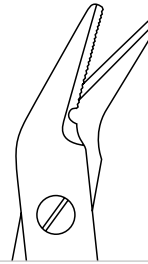

12 cm - 4¾"

14.23.62

Ø = 0,3 mm

Ø = 0,8 mm



eine Schneide gezahnt
 one blade serrated
 una hoja dentada
 une lame dentelée
 una lama dentellata

Rippen-Raspatorien
 Rib raspatories
 Legras para costillas
 Rugines costales
 Periostotomi per le costole

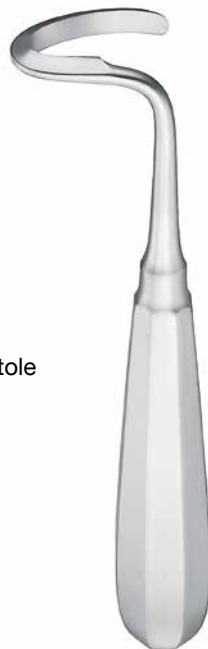

Doyen

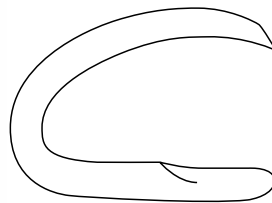

17 cm - 6¾"

54.30.11

R

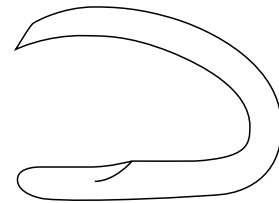

17 cm - 6¾"

54.30.12

L

max.

Harte Drähte
 Hard wires
 Alambres duros
 Fils durs
 Fili duri

max.

Weiche Drähte
 Soft wires
 Alambres blandos
 Fils mous
 Fili dolci

L

links
 left
 izquierdo
 gauche
 sinistro

R

rechts
 right
 derecho
 droite
 destro



Instrumente für die Ohrmuschelplastik
Instruments for Auricular Plastic
Instrumentos para la otoplastia
Instrumentes pour l'otoplastie
Strumenti per l'otoplastica

J01

Fixierdraht mit Nadeln
 Fixation wire with needles
 Alambre de fijación con agujas
 Fil d'acier pour la fixation avec aiguilles
 Filo di fissaggio con aghi

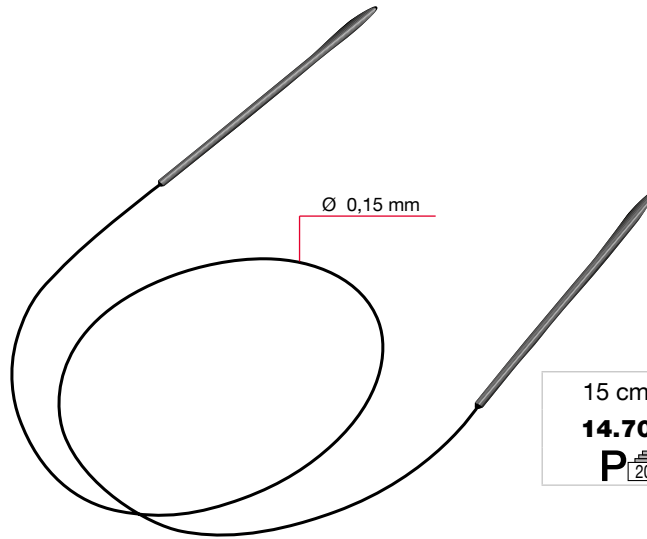

15 cm - 6"
14.70.10
 P 

Elevatorien
 Elevators
 Elevadores
 Elévateurs
 Elevatori

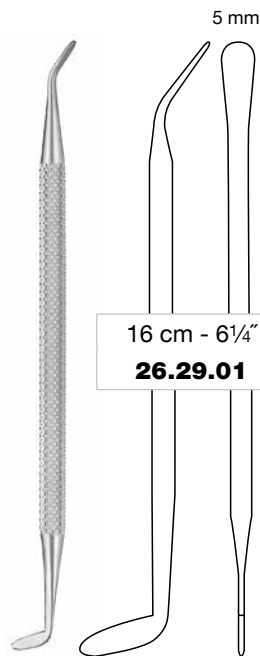

5 mm
 16 cm - 6 1/4"
26.29.01



Nagata

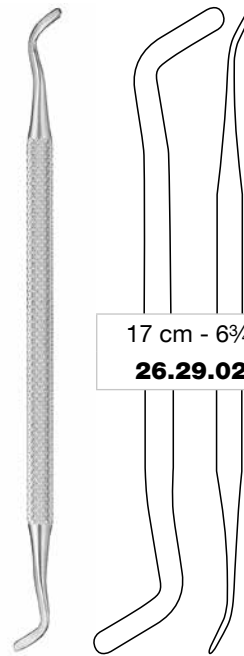

17 cm - 6 3/4"
26.29.02



Nagata

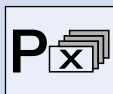

Verpackungseinheit "X" Stück, steril
 Packing unit "X" pieces, sterile
 Paquete de "X" unidades, estériles
 Emballage de "X" pièces, stériles
 Confezione da "X" pezzi, sterili



stumpf
 blunt
 roma
 mousse
 smussa

Anthelix-Knorpelfeilen für die Ohrmuschelplastik
Anthelix Cartilage Files for Auricular Plastic
Limas para el cartilago del anthelix para la otoplastia
Limes pour le cartilage de l'anthélix pour l'otoplastie
Lime per cartilagine del anthelix per l'otoplastica

J02



vorher
before
antes
avant
prima



nachher
after
después
après
dopo



VORTEILE
ADVANTAGES
VENTAJAS
AVANTAGES
VANTAGGI

- ▶ Verbessertes Handling durch die anatomiegerechte, s-förmige Gestaltung des Instruments.
 - ▶ Einfache Dissektion des neu zu bildenden Anthelixknickes an der Vorderseite.
 - ▶ Erst beim Zurückziehen des Instruments wird das Perichondrium auf der Vorderseite der Ohrmuschel entlang des neu zu bildenden Anthelixknickes eingeritzt.
 - ▶ Optimale Formgebung nach Abschluss der Wundheilung definitiv fixiert und auch mit resorbierbarem Nahtmaterial sicher gewährleistet.
- ▶ Improved handling due to its anatomical, S-shaped design.
 - ▶ Simple dissection of the anterior anthelix fold to be reshaped.
 - ▶ Only when pulling back the instrument the perichondrium is scratched on the front side of the concha along the reshaped anthelix fold.
 - ▶ Optimum shape after complete wound healing, definitively fixed and secured also when using absorbable sutures.
- ▶ Manejo mejorado gracias a la forma anatómica en „S“ del instrumento.
 - ▶ Disección fácil del futuro pliegue del anthelix en la parte anterior.
 - ▶ Al retirar el instrumento, el pericondrio se entalla en la parte anterior del pabellón auricular a lo largo del futuro pliegue del anthelix.
 - ▶ Se garantiza un modelado óptimo permanente tras la recuperación también con material de sutura reabsorbible.
- ▶ Manipulation plus aisée grâce à la conception ergonomique en forme de S de l'instrument.
 - ▶ Dissection aisée en vue de reconstruire le relief de l'anthélix sur la face externe de l'oreille.
 - ▶ Le périchondre n'est incisé que lors du retrait de l'instrument, et ce sur la face externe du pavillon de l'oreille le long du relief de l'anthélix à reconstruire.
 - ▶ Modelage optimal et définitif une fois le processus de guérison terminé, également garanti avec du matériel de suture résorbable.
- ▶ Maneggevolezza migliorata grazie alla forma a S dello strumento, adattata all'anatomia.
 - ▶ Facile dissezione della piega dell'antelice da rimodellare nella parte anteriore.
 - ▶ Solo durante il ritiro dello strumento il pericondrio viene inciso nella parte anteriore del padiglione auricolare lungo la piega dell'antelice che deve essere rimodellata.
 - ▶ Modellatura ottimale e fissaggio definitivo dopo il processo di guarigione, garantito anche con materiale di sutura riassorbibile.

**J02**

Anthelix-Knorpelfeilen für die Ohrmuschelplastik
Anthelix Cartilage Files for Auricular Plastic
Limas para el cartilago del anthelix para la otoplastia
Limes pour le cartilage de l'anthélix pour l'otoplastie
Lime per cartilagine del anthelix per l'otoplastica

**Kistler**

Die Zahnung (Abstand = 1 mm) ist auf Zugwirkung angeordnet. Eine Längsrifung (0,5 mm) teilt diese in zwei parallel stehende Zahnreihen. Die Knorpelhaut wird dadurch ausreichend eingeritzt.

The tothing (1 mm interval) is designed to exert a traction force. A longitudinal channel (0.5 mm) divides it into two parallel rows of teeth. This ensures that the perichondrium is sufficiently scratched.

El dentado (distancia = 1 mm) está dispuesto sobre un efecto tractor. Un estriado longitudinal (0,5 mm) lo divide en dos filas dentadas paralelas. El pericondrio se entalla de este modo suficientemente.

La denture (écart 1 mm) est disposée de manière à inciser lorsqu'une traction est exercée sur l'instrument. Une rainure longitudinale (0,5 mm) sépare la denture en deux dentures parallèles, ce qui permet d'entailler la peau qui recouvre le cartilage.

La dentellatura (distanza = 1 mm) è predisposta per la trazione. Una scanalatura longitudinale (0,5 mm) la divide in due righe di denti paralleli. Ciò consente di incidere a sufficienza la cartilagine.

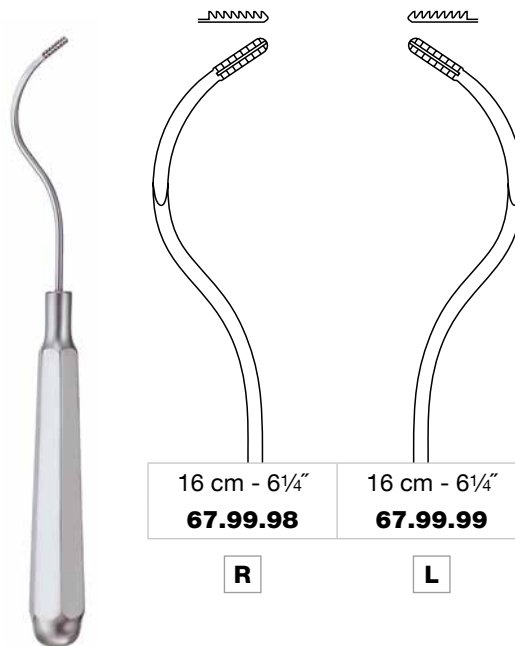
**Kistler**

L links
left
izquierdo
gauche
sinistro

R rechts
right
derecho
droite
destro



**Instrumente für die Handchirurgie
Instruments for Hand Surgery
Instrumentos para la cirugía de mano
Instruments pour la chirurgie de la main
Strumenti per la chirurgia della mano**

K

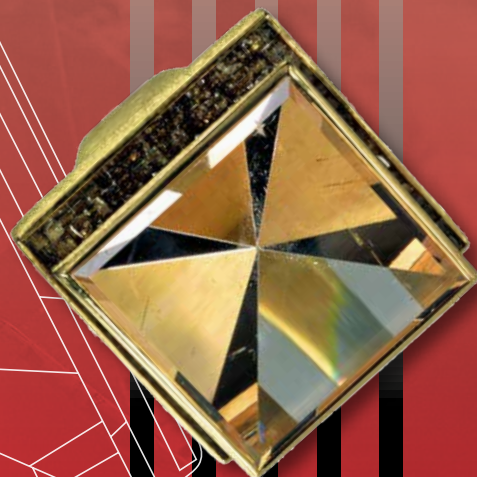

Z O B E L

**K01**

**Sonde, Fingerspreizer, Knochenpfriem
Probe, Finger Spreader, Bone Piercer
Estilet, Separador para dedos, Punzon
Stylet, Ecarteur à doigts, Alèse à os
Sonda, Divaricatore per le dita, Puntaruolo**

Sonde
Probe
Estilet
Stylet
Sonda

**Bunnell**

16,5 cm - 6½"
78.29.14

Fingerspreizer
Finger spreader
Separador para dedos
Ecarteur à doigts
Divaricatore per le dita



8 cm - 3⅛"
43.49.01

Knochenpfriem
Bone piercer
Punzón
Poinçon
Punteruolo



17 cm - 6¾"
78.03.02

Mod. Lanz**NOVOTEX**

- ▶ Ein duroplastischer Kunststoff aus der Familie der Phenoplaste
- ▶ Sehr hart und bruchbeständig
- ▶ Thermosetting plastics of the phenol formaldehyde resins family
- ▶ Very hard and break resistant
- ▶ Plástico termoendurecible de la familia de resina fenol-formaldehído
- ▶ Muy duro y resistente a la rotura
- ▶ Plastique thermodurcissable de la famille des résines phénol-formaldéhyde
- ▶ Très dur et résistant à la casse
- ▶ Materia plastica termoindurente della famiglia di resine fenoliche
- ▶ Molto duro e resistente alla rottura



Kunststoffgriff (autoklavierbar bis 134 °C bei 3 bar)
Plastic handle (autoclavable up to 134 °C at 3 bar)
Mango de plástico (autoclavable hasta 134 °C bajo presión de 3 bar)
Manche en plastique (autoclavable à 134 °C sous pression de 3 bars)
Manico di plastica (autoclavabile fino a 134 °C sotto pressione di 3 bar)





Hohlmeißelzangen
Bone rongeurs
Pinzas gubias
Pincers-gouges
Pinze sgorbie

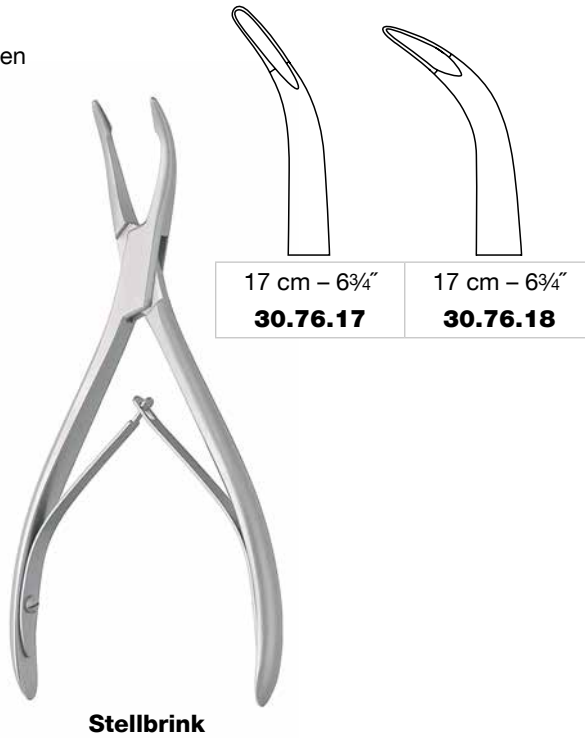

Knochenhaltezange
Bone holding forceps
Pinza prensora para huesos
Davier à os
Tenaglia per ossa



Phalangenhaltezange
Phalanx holding forceps
Pinza de agarrar falanges
Pince pour tenir les phalanges
Pinza da presa per falangi

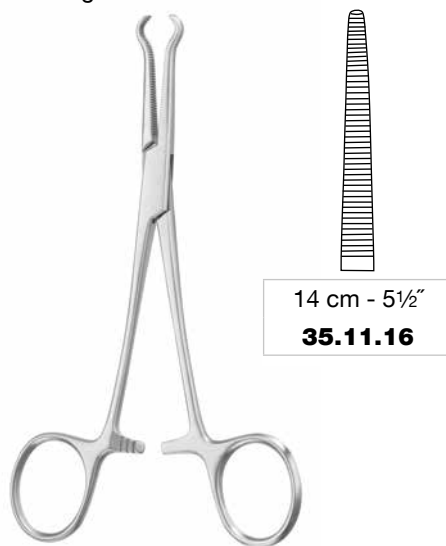

Sehnenhaltezange
Tendon grasping forceps
Pinza para sujetar tendones
Pince à préhension pour tendons
Pinza per afferrare tendini





Sehnenführungszangen
Tendon Tunneling Forceps
Pinzas conductoras para tendones
Pinces conductrices pour tendons
Pinze passa tendini

K01

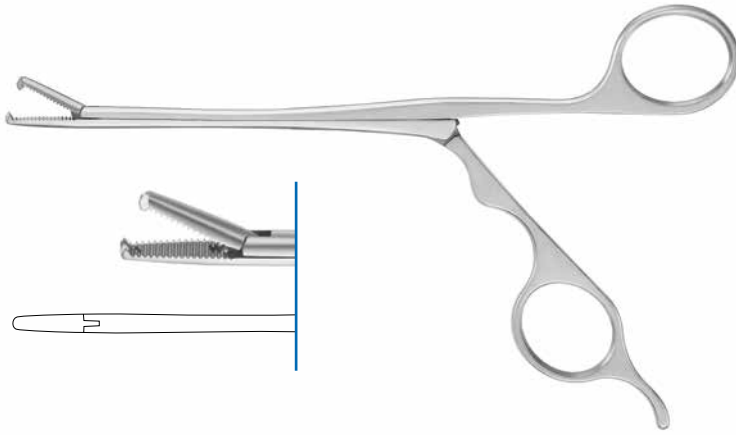

Brand



15 cm - 6"
78.10.15



19 cm - 7½"
78.10.19



25 cm - 10"
78.10.25

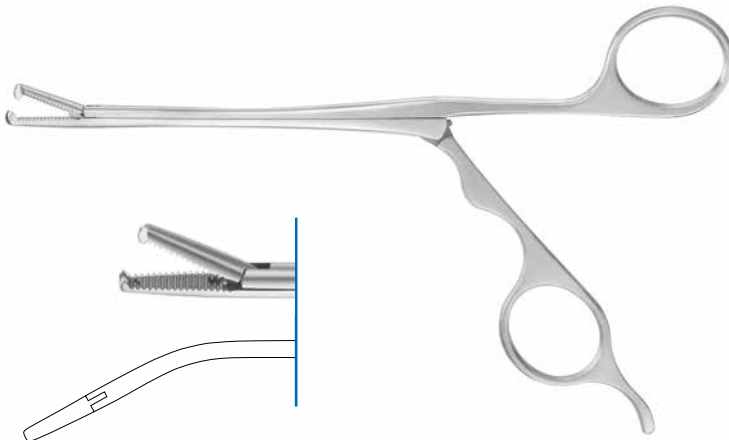

Brand



15 cm - 6"
78.11.15



19 cm - 7½"
78.11.19





25 cm - 10"
78.11.25

Sehnenführungsanzagen
Tendon Tunneling Forceps
Pinzas conductoras para tendones
Pinces conductrices pour tendons
Pinze passa tendini

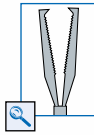
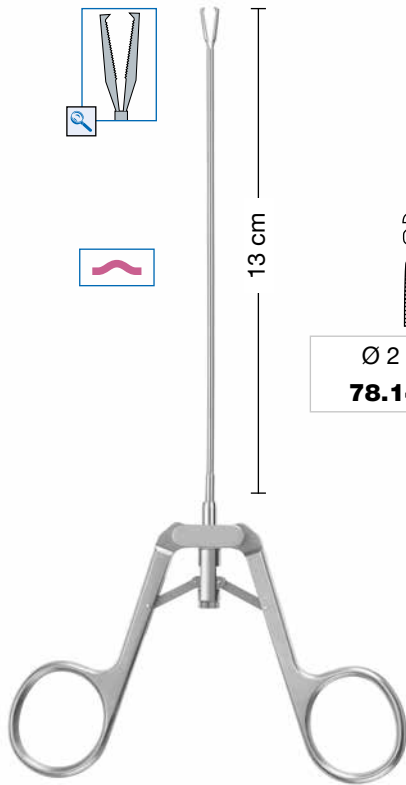
K01



13 cm

	
Ø 2 mm 78.14.40	Ø 2,5 mm 78.14.42



20 cm - 8" 78.14.20	20 cm - 8" 78.14.21
-------------------------------	-------------------------------

Kleinert-Kutz

Sehneneinflecht-klemmen
 Tendon interlacing forceps
 Pinzas para entrelazar tendones
 Pinces pour entrelacer les tendons
 Pinze per intrecciare tendini

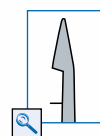

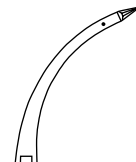
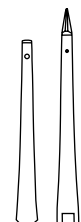
		
15 cm - 6" 78.12.15	15 cm - 6" 78.12.16	



biegbar
 malleable
 maleables
 malléables
 malleabili



Vergrößerung
 Magnification
 Engrandecimiento
 Agrandissement
 Ingrandimento



Sehnenführer
Tendon Passers
Pasadores de tendones
Conducteurs de tendons
Guidatendini

K01



Framer

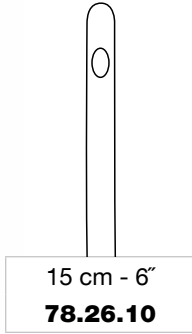

15 cm - 6"
78.26.10



Framer

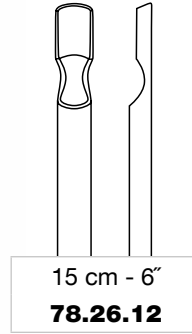

15 cm - 6"
78.26.12



Bunnell

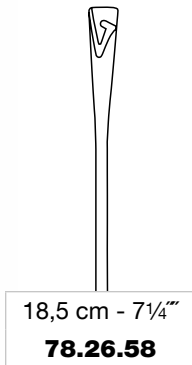

18,5 cm - 7 1/4"
78.26.58

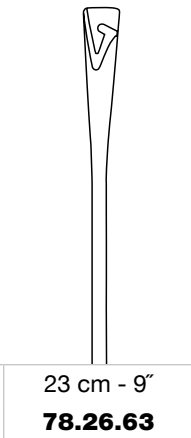

23 cm - 9"
78.26.63



biegbar
malleable
maleables
malleables
malleabili

Sehnenschäler
Tendon Stripper
Enucleadores de tendones
Décollecteurs de tendons
Enucleatori per tendini

K01

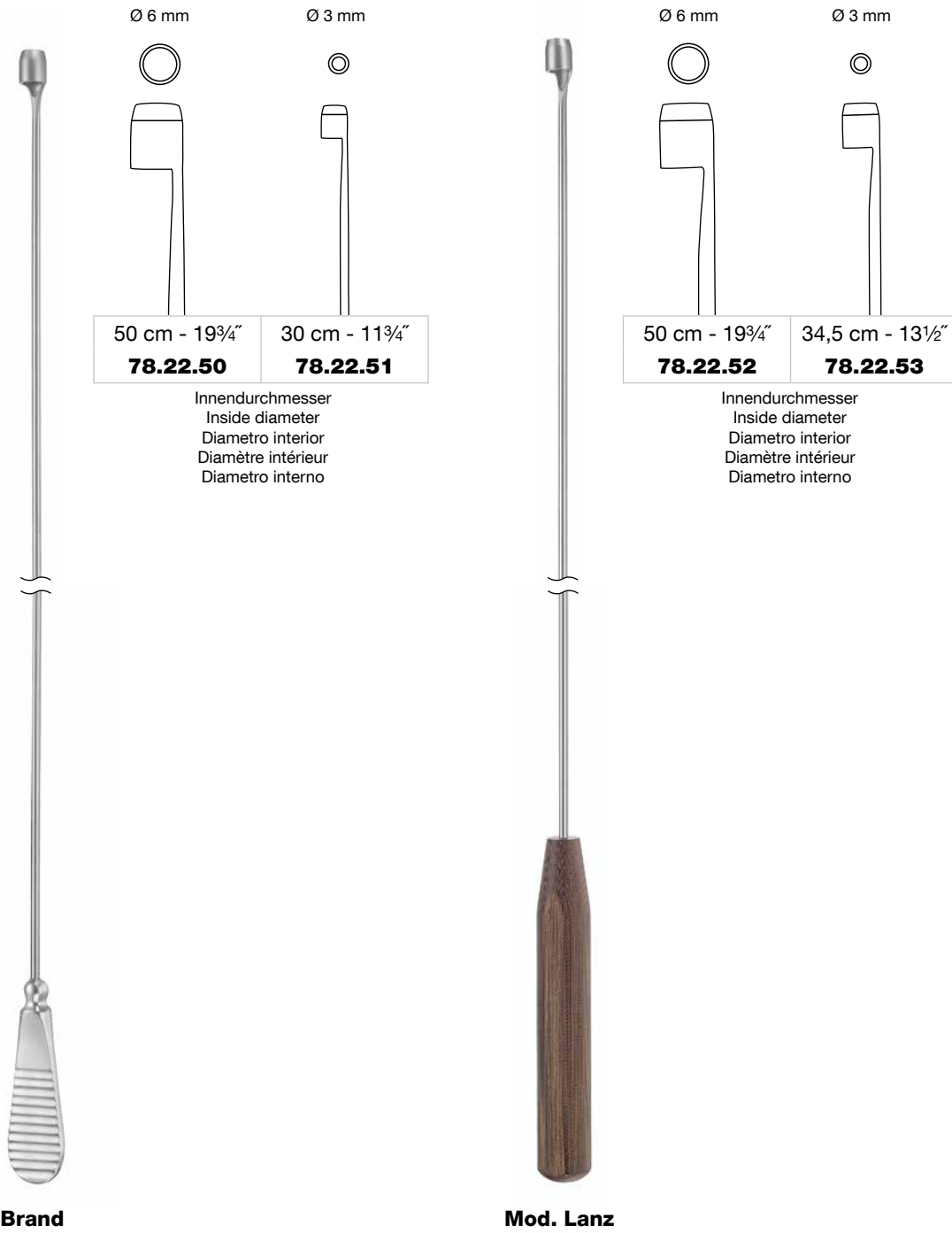

Endoskopische Spaltung des Karpalbandes
Endoscopic Incision of the Carpal Ligament
Escisión endoscópica del ligamento carpiano
Dédoublément endoscopique du ligament du carpe
Sezione endoscopica del legamento carpale



Vorteile
Advantages
Ventajas
Avantages
Vantaggi

- ▶ Verkürzte postoperative Ruhigstellung
- ▶ Schnellere Erholungsphase der Hand
- ▶ Besseres kosmetisches Ergebnis
- ▶ Kürzere Operationszeit

- ▶ Reduced postoperative resting period
- ▶ Shorter recovery period of the hand
- ▶ Improved cosmetic result
- ▶ Reduced operating time

- ▶ Reducción del período de reposo de la mano
- ▶ Menor tiempo de convalecencia de la mano
- ▶ Mejor resultado cosmético
- ▶ Duración acortada de la intervención quirúrgica

- ▶ Réduction du temps de l'immobilisation postopératoire
- ▶ Guérison plus rapide de la main
- ▶ Meilleur résultat au niveau de l'esthétique
- ▶ Réduction du temps de l'intervention chirurgicale

- ▶ Riduzione del periodo di immobilizzazione postoperatoria
- ▶ Periodo di convalescenza della mano più breve
- ▶ Migliore risultato estetico
- ▶ Riduzione dei tempi di intervento

Endoskop und Endoskop-Führung
Endoscope and Endoscope Guide
Endoscopio y guía para endoscopios
Endoscope et guide pour endoscopes
Endoscopio e guida per endoscopi

K02

inklusive Adapter zum Anschluß für Lichtleitkabel
 including adapter for connection to fibre optic cable
 con adaptador para la conexión del cable conductor de luz
 avec adaptateur pour la connexion du câble conducteur de lumière
 compreso adattatore per l'attacco di cavo conduttore di luce

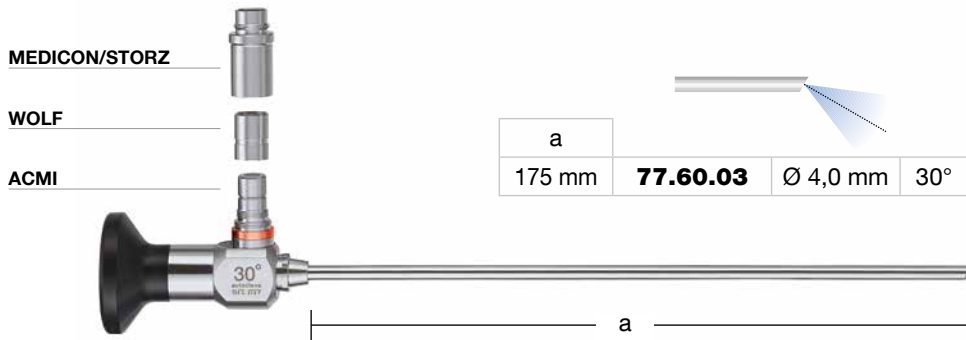

Tray für Endoskope (siehe Seite 272)
 Tray for endoscopes (see page 272)
 Bandeja para endoscopios (véase página 272)
 Cassette pour endoscopes (voyez page 272)
 Cassetta per endoscopi (vedete pagine 272)

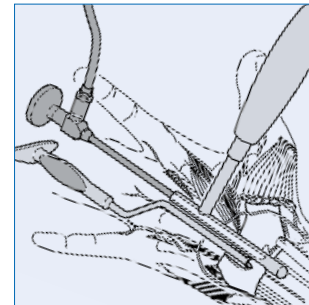

Endoskop-Führung
 Endoscope guide
 Guía para endoscopios
 Guide pour endoscopes
 Guida per endoscopio



für Endoskope
 for endoscopes
 para endoscopios **77.60.03**
 pour endoscopes
 per endoscopi

16 cm - 6¼"
78.50.01



K02

**Messer
Knives
Cuchillos
Couteaux
Coltelli**

mit Schutzplatte
with protection plate
con placa de proteccion
avec plaque de protection
con placca di protezione

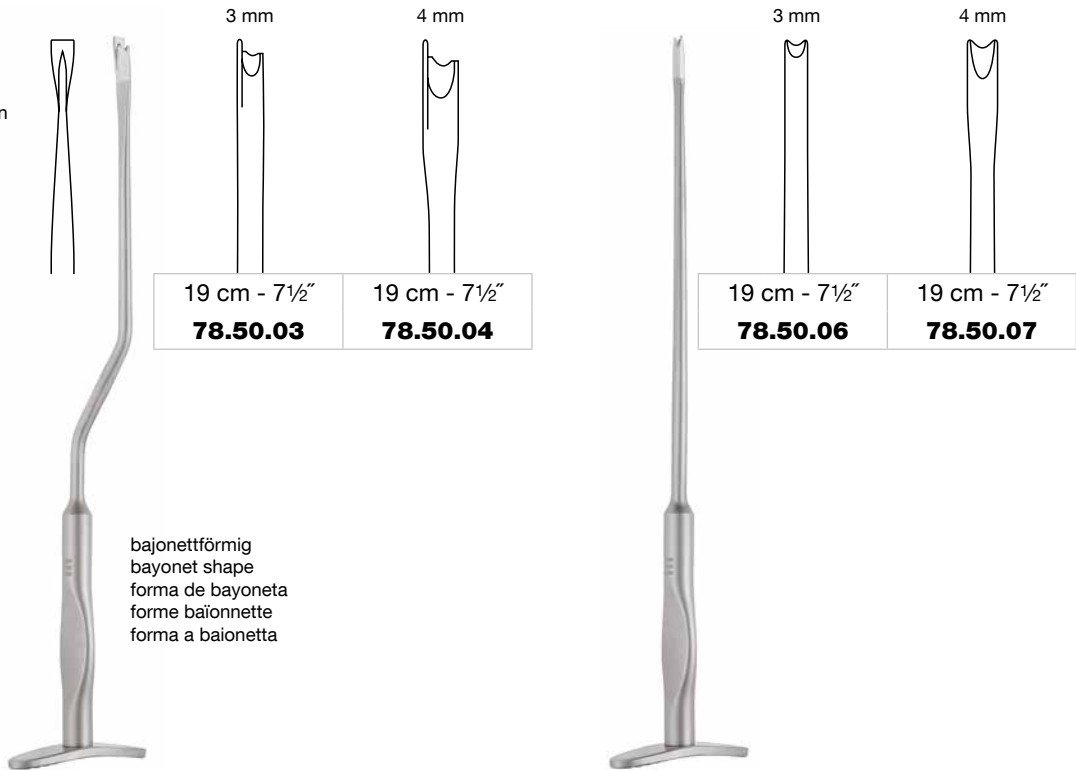

bajonettförmig
bayonet shape
forma de bayoneta
forme baïonnette
forma a baionetta

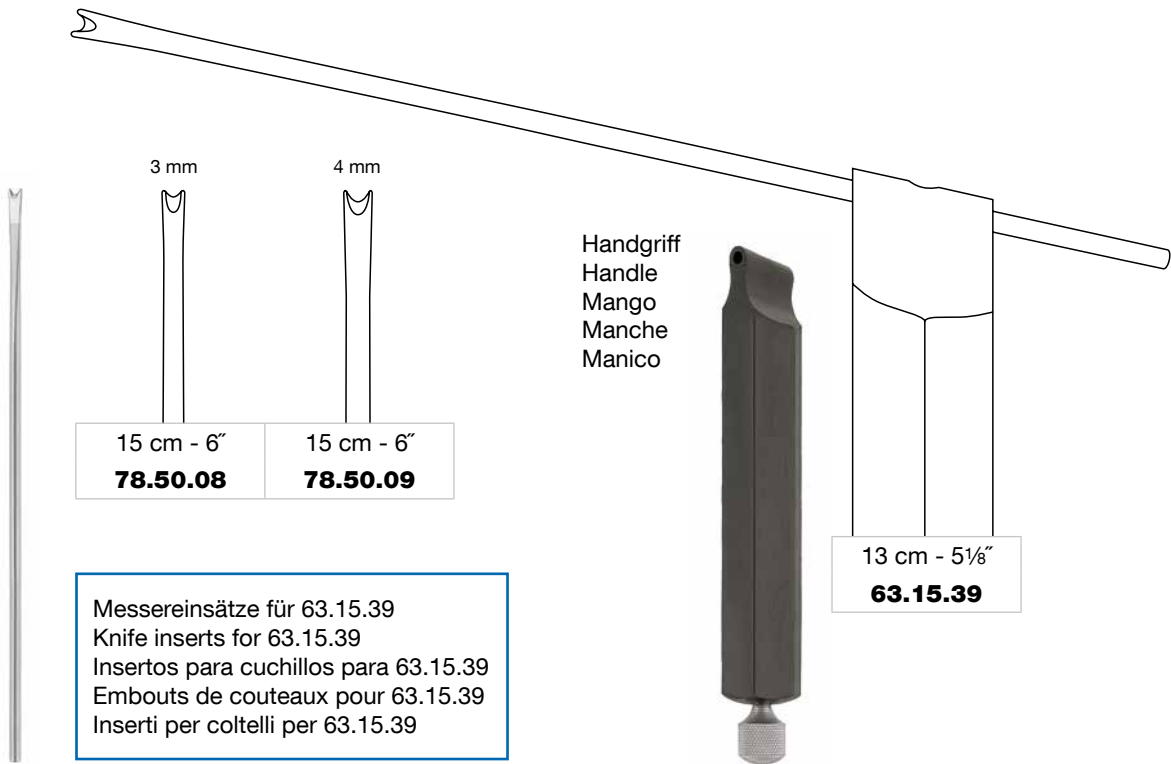

Messereinsätze für 63.15.39
Knife inserts for 63.15.39
Insertos para cuchillos para 63.15.39
Embouts de couteaux pour 63.15.39
Inserti per coltelli per 63.15.39

Heermann

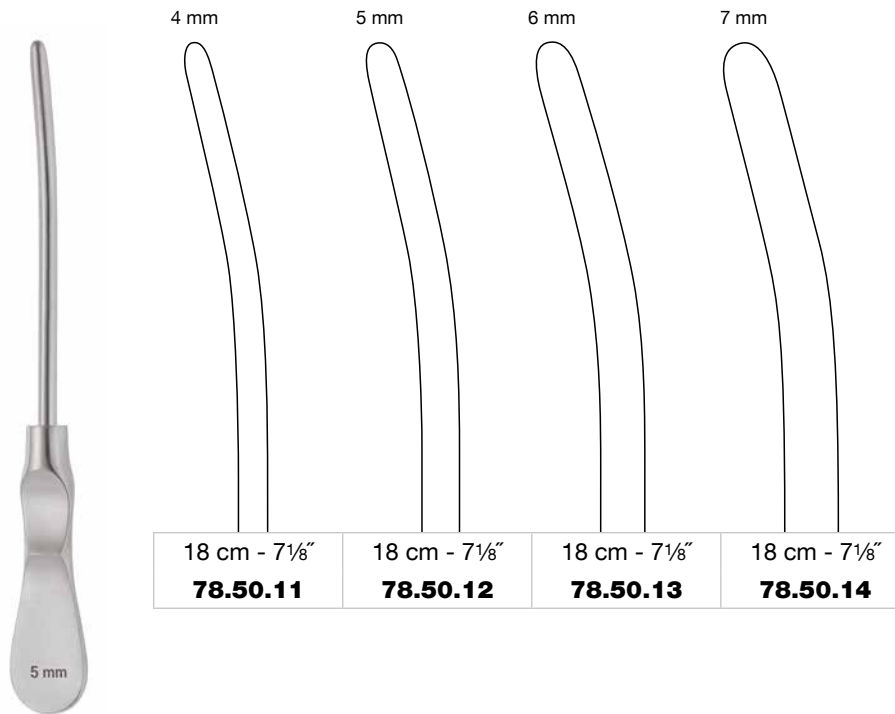

Mit Hilfe der verschiedenen Dilatationsstifte wird der Raum zwischen Palmarfaszie und Ligamentum carpi transversum geweitet.

The space between palmar fascia and the ligamentum carpi transversum must be exposed and widened using the various dilation rods.

Se ensancha el espacio entre la fascia palmar y el ligamento transversal del carpo con ayuda de los diferentes punzones de dilatación.

La région entre l'aponévrose et le ligament transversal du carpe est agrandie à l'aide des différents pivots de dilatation.

Tramite i diversi perni di dilatazione è possibile allargare lo spazio tra la fascia palmare e il legamento traverso.

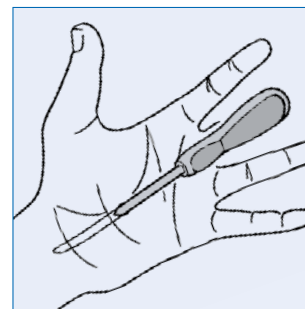

**K02**

Handfixierplatte, autoklavierbar
Hand Fixation Plate, autoclavable
Bandeja de fijación de la mano, autoclavable
Plaque pour la fixation de la main, autoclavable
Piastra per il fissaggio della mano, autoclavabile

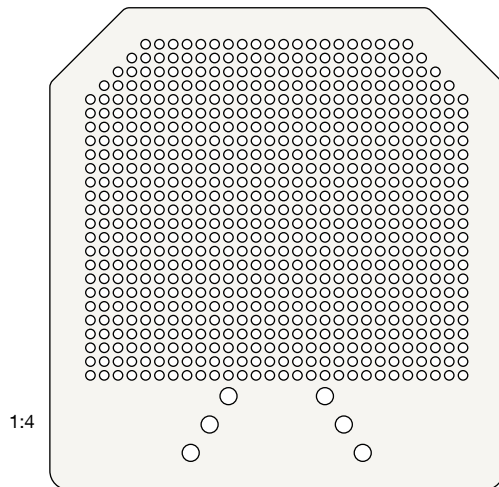

255 × 240 × 8 mm
78.00.20

Funke

- ▶ für individuelle und variable Fixierung
- ▶ geringes Gewicht
- ▶ passend in MEDICONTAINER: A / B (siehe Seite 269)

- ▶ for individual and variable fixation
- ▶ extremely light weight
- ▶ suitable for MEDICONTAINER: A / B (see page 269)

- ▶ para fijaciones individuales y variables
- ▶ peso muy ligero
- ▶ apropiado para los MEDICONTAINER: A / B (vea página 269)

- ▶ pour des fixations individuelles et variables
- ▶ poids léger
- ▶ approprié pour les MEDICONTAINER: A / B (voyez page 269)

- ▶ per un fissaggio individuale e variabile
- ▶ peso minimo
- ▶ appropriato per i MEDICONTAINER: A / B (vedete pagina 269)

Optionales Zubehör
 Optional accessories
 Accesorios opcionales
 Accessoires optionnels
 Accessori opzionali



16.10.13/16

für die Fingerfixierung:
 for finger fixation:
 para la fijación de los dedos:
 pour la fixation des doigts:
 per il fissaggio delle dita:

16.10.13

Arterienklemme PEAN (13 cm, gerade, 5 Stück erforderlich)
 Hemostatic forceps PEAN (13 cm, straight, 5 pieces necessary)
 Pinza hemostática PEAN (13 cm, recta, se necesita 5 piezas)
 Pince hémostatique PEAN (13 cm, droite, il en faut 5 pièces)
 Pinza emostatica PEAN (13 cm, retta, necessario 5 pezzi)

für die Armfixierung:
 for arm fixation:
 para la fijación del brazo:
 pour la fixation du bras:
 per il fissaggio del braccio:

16.10.16

Arterienklemme ROCHESTER-PEAN (16 cm, gerade, 1 Stück erforderlich)
 Hemostatic forceps ROCHESTER-PEAN (16 cm, straight, 1 piece necessary)
 Pinza hemostática ROCHESTER-PEAN (16 cm, recta, se necesita 1 pieza)
 Pince hémostatique ROCHESTER-PEAN (16 cm, droite, il en faut 1 pièce)
 Pinza emostatica ROCHESTER-PEAN (16 cm, retta, necessario 1 pezzo)

**451.02.91**

Weitere Medicon-Produkte finden Sie in unserem Prospekt "Manus".
 You will find further Medicon products in our special brochure "Manus".
 Más productos de Medicon se encuentran en nuestro folleto aparte "Manus".
 Vous trouverez d'autres produits Medicon dans notre prospectus "Manus".
 Altri prodotti Medicon si trovano nel nostro depliant "Manus".

Lagerung und Sterilisation
Storage and Sterilization
Almacenamiento y esterilización
Rangement et stérilisation
Magazzinaggio e sterilizzazione

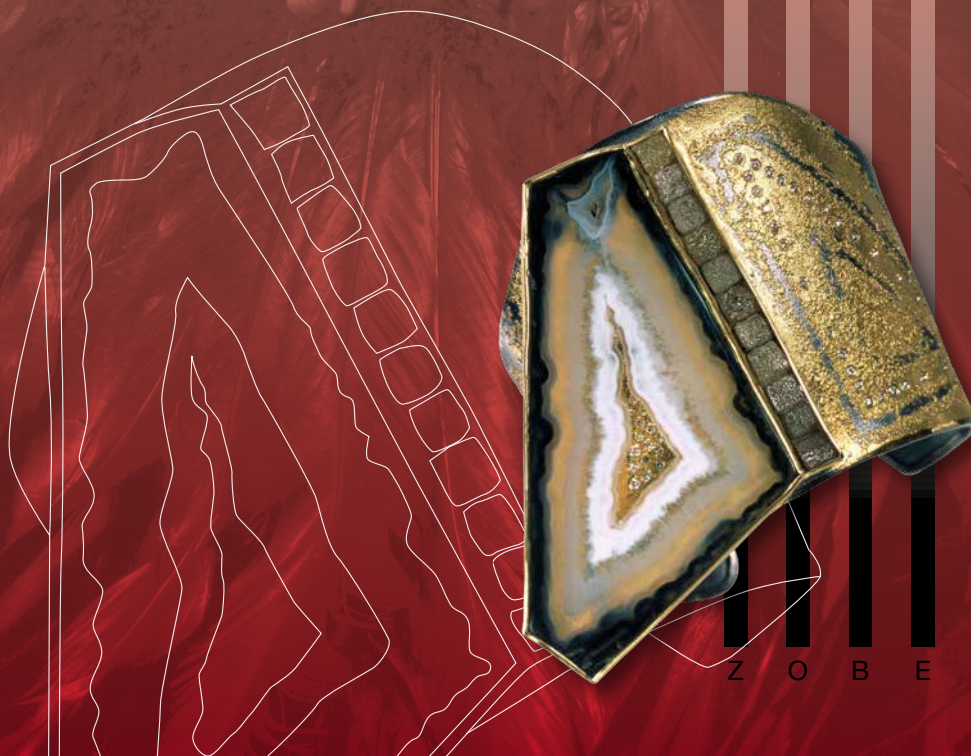

Z O B E L

L01

Sterilgut-Container aus Aluminium
Aluminium Containers for Sterilization
Contenedores de aluminio para la esterilización
Containers en aluminium pour la stérilisation
Contenitori in alluminio per sterilizzazione



- ▶ Höchst effektive Nachtrocknung im Container-Innenbereich
- ▶ Silikondichtung gewährleistet Langzeit-Sterilität
- ▶ Farbige Deckel und Kennzeichnungsschilder verbessern die Organisation
- ▶ Ausstattung der Deckel mit Papierfiltern

- ▶ Extremely effective drying phase of the container interior
- ▶ Silicone sealings ensure long-term sterility
- ▶ Coloured lids and identification labels for better organization
- ▶ Lids are equipped with paper filters

- ▶ Secado del interior del contenedor altamente eficaz
- ▶ La junta de silicona asegura una esterilidad de larga duración
- ▶ Tapas en color y etiquetas de identificación para una mejor organización
- ▶ Las tapas están equipados con filtros de papel

- ▶ Séchage de l'intérieur du container extrêmement efficace
- ▶ La joint en silicone garantit une stérilité à longue durée
- ▶ Couvercles en couleurs et étiquettes d'identification pour une meilleure organisation
- ▶ Couvercles sont munis de filtres de papier

- ▶ Asciugatura altamente efficace nell'interno del contenitore
- ▶ La guarnizione in silicone garantisce una sterilità a lunga durata
- ▶ Coperchi colorati ed etichette d'identificazione per un'organizzazione migliore
- ▶ I coperchi sono corredati da filtri di carta

Unser komplettes MEDICONTAINER-Programm (mit optionalem Zubehör) finden Sie in unserem Sonderprospekt.
 For our complete MEDICONTAINER program (with optional accessories) please ask for our special brochure.
 Nuestro programa completo de MEDICONTAINER (con accesorios opcionales) se encuentra en nuestro folleto especial.
 Vous trouverez notre programme complet des MEDICONTAINER (avec accessoires optionnels) dans notre prospectus spécial.
 Il nostro programma completo di MEDICONTAINER (con accessori opzionali) lo troverete nel depliant speciale.

Sterilgut-Container aus Aluminium
Aluminium Containers for Sterilization
Contenedores de aluminio para la esterilización
Containers en aluminium pour la stérilisation
Contenitori in alluminio per sterilizzazione

L01

silber eloxiert, inkl. Papierfilter
 silver anodized, incl. paper filter
 anodizado en plata con filtro de papel
 couleur argent anodisé avec filtre de papier
 color argento anodizzato con filtri di cartace

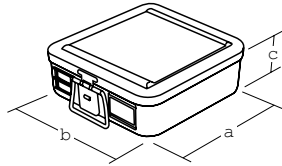

	a = 290 mm / b = 290 mm
c = 100 mm	49.50.10
c = 135 mm	49.50.13
c = 150 mm	49.50.15
c = 170 mm	49.50.17
c = 220 mm	49.50.22

Deckel gelocht – Boden ungelocht
 Lid perforated – Bottom non-perforated
 Tapa perforada – Fondo no perforado
 Couvercle perforé – Fond non-perforé
 Coperchio forato – Fondo non forato

silber eloxiert, inkl. Papierfilter
 silver anodized, incl. paper filter
 anodizado en plata con filtro de papel
 couleur argent anodisé avec filtre de papier
 color argento anodizzato con filtri di cartace

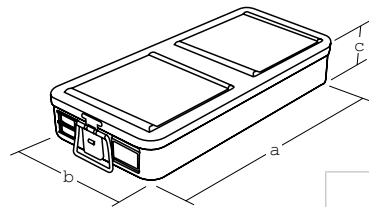

	a = 590 mm / b = 290 mm
c = 100 mm	49.60.10
c = 135 mm	49.60.13
c = 150 mm	49.60.15
c = 170 mm	49.60.17
c = 220 mm	49.60.22

Deckel gelocht – Boden ungelocht
 Lid perforated – Bottom non-perforated
 Tapa perforada – Fondo no perforado
 Couvercle perforé – Fond non-perforé
 Coperchio forato – Fondo non forato



L02

Trays für feine Instrumente
Trays for Delicate Instruments
Bandejas para instrumentos delicados
Cassettes pour instruments délicats
Cassette per strumenti delicati

Für eine schonende Aufbereitung und Lagerung von feinen und empfindlichen Instrumenten, wie z.B. mikrochirurgischen Instrumenten und feinen Häkchen. Die Trays können in Sterilisiercontainern, z.B. MEDICONTAINER, zusammen mit dem übrigen Instrumentarium sterilisiert und aufbewahrt werden.

For a careful sterilization and storage of fine and delicate instruments, for example micro surgery instruments and fine hooks. The trays may be sterilized and stored together with the instruments in sterilizing containers, for example MEDICONTAINER.

Para un tratamiento cuidadoso y para el almacenamiento de instrumentos delicados como p.ej. micro instrumentos y ganchitos finos. Las bandejas pueden ser esterilizadas y almacenadas en un contenedor para la esterilización, p.ej. los MEDICONTAINER.

Pour une préparation et un stockage avec ménagement d'instruments fins et délicats, comme p.ex. des instruments microchirurgicaux et des crochets fins. Les cassettes peuvent être stérilisées et rangées dans des containers de stérilisation comme p.ex. des MEDICONTAINER, ensemble avec d'autres instruments.

Per un'accurata preparazione ed un magazzino di strumenti delicati e fini, come p.e. strumenti per la microchirurgia ed uncini delicati. Le cassette possono essere sterilizzate e magazzino in contenitori per sterilizzazione, come p.e. i nostri MEDICONTAINER, insieme ad altri strumenti.



- ▶ autoklavierbar bis 134 °C bei 3 bar
- ▶ geringes Gewicht
- ▶ einfaches und sicheres Verschlusssystem
- ▶ in leichter Kunststoffbauweise

- ▶ autoclavable up to 134 °C at 3 bar
- ▶ extremely light weight
- ▶ simple and secure locking system
- ▶ lightweight plastic construction

- ▶ autoclavable hasta 134 °C bajo presión de 3 bar
- ▶ peso muy ligero
- ▶ cierre fácil y seguro
- ▶ construcción ligera de material plástico

- ▶ autoclavable à 134 °C sous pression de 3 bars
- ▶ poids léger
- ▶ système de fermeture simple et sûr
- ▶ construction légère en matière plastique

- ▶ autoclavabile fino a 134 °C sotto pressione di 3 bar
- ▶ peso minimo
- ▶ sistema di chiusura facile e sicura
- ▶ costruzione leggera in materiale plastico

Lieferung ohne Instrumente
 Supplied without instruments
 Entrega sin instrumentos
 Livraison sans instruments
 Fornitura senza strumenti

Trays für feine Instrumente
Trays for Delicate Instruments
Bandejas para instrumentos delicados
Cassettes pour instruments délicats
Cassette per strumenti delicati

L02



49.90.00

190 × 102 × 19 mm

mit Silikonmatte, stapelbar
 with silicone mat, stackable
 con estera de silicona, apilable
 avec tapis en silicone, empilable
 con tappetino a grumelli, impilabile



49.90.02

280 × 170 × 55 mm

Tray für 12 Instrumente
 Tray for 12 instruments
 Bandeja para 12 instrumentos
 Cassette pour 12 instruments
 Cassetta per 12 strumenti

mit Haltestegen für festen und sicheren Halt
 with holding device for a firm and safe storage
 con dispositivo de fijación para una sujeción buena y segura
 avec dispositif de fixation pour une fixation sûre
 con dispositivo di fissazione per un fissaggio sicuro



49.90.04

203 × 114 × 30 mm



Kunststoff (autoklavierbar bis 134 °C bei 3 bar)
 Plastic (autoclavable up to 134 °C at 3 bar)
 Plástico (autoclavable hasta 134 °C bajo presión de 3 bar)
 Plastique (autoclavable à 134 °C sous pression de 3 bars)
 Plastica (autoclavabile fino a 134 °C sotto pressione di 3 bar)

**L02**

Trays für Endoskope
Trays for Endoscopes
Bandejas para endoscopios
Cassettes pour endoscopes
Cassette per endoscopi



Trays aus Kunststoff, zur Lagerung von 2 Optiken wie z.B. Sinuskope, Arthroskope (77.60.49) und Laparoskope (91.10.49), inklusive Auswerfer für verstellbare Bodenstege

Plastic trays, for storage of 2 sinusscopes, arthroscopes (77.60.49) and laparoscopes (91.10.49), inclusive ejector for adjustable base bars

Bandejas de plástico, para almacenar 2 ópticas como p. ej. sinuscopios, artroscopios (77.60.49) y laparoscopios (91.10.49), incluso expulsor para elementos ajustables del fondo

Cassettes en plastique, pour stockage de 2 optiques p. e. des sinuscopes, arthroscopes (77.60.49) et laparoscopes (91.10.49), complet avec éjecteur pour éléments réglables du fond

Cassette di plastica, per il magazzino di 2 ottiche come p. es. sinuscopi, artroscopi (77.60.49) e laparoscopi (91.10.49), con espulsore per appoggi regolabili

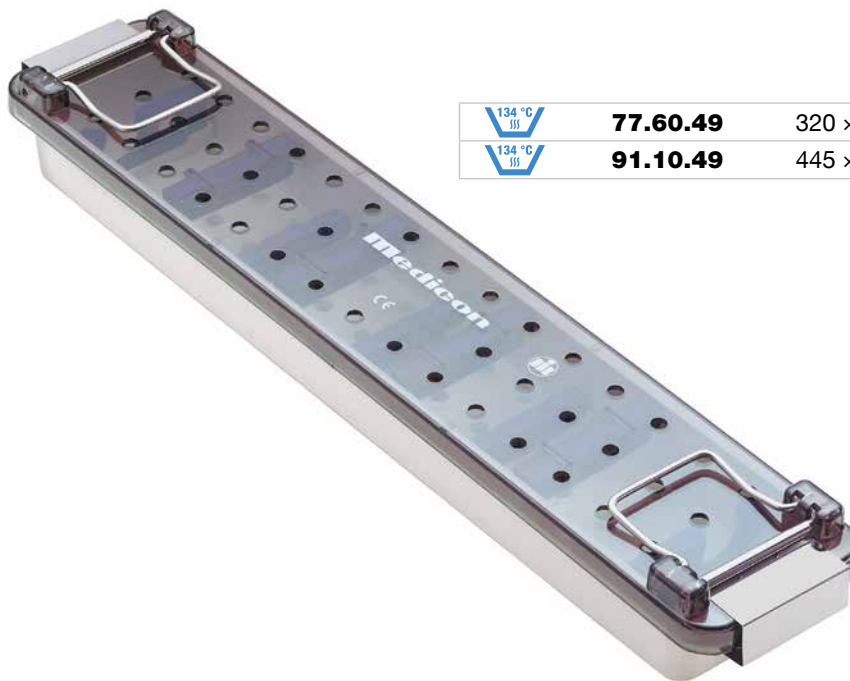

	77.60.49	320 × 85 × 50 mm
	91.10.49	445 × 85 × 50 mm



Kunststoff (autoklavierbar bis 134 °C bei 3 bar)
 Plastic (autoclavable up to 134 °C at 3 bar)
 Plástico (autoclavable hasta 134 °C bajo presión de 3 bar)
 Plastique (autoclavable à 134 °C sous pression de 3 bars)
 Plastica (autoclavabile fino a 134 °C sotto pressione di 3 bar)



Instrumentenablage, magnetisch
Instrument Mat, magnetic
Estera para instrumentos, magnética
Tapis pour instruments, magnétique
Tappetino per strumenti, magnetico

L03



MAGGY

magnetic mat

- ▶ Sichert Instrumente auf der Patientenbrust und dem Gerätewagen
- ▶ Patentierte Magnettechnologie, antimagnetisch für Instrumente
- ▶ Patientenangepasste Formgebung für optimale Platznutzung
- ▶ Mindestens 100 Sterilisationszyklen bei 134 °C garantiert

- ▶ For placing instruments safely on the patient's chest or trolley
- ▶ Patented magnet technology, without magnetizing instruments
- ▶ Patient adapted design for an optimal use of space
- ▶ Autoclavable soft silicone construction guarantees a minimum of 100 sterilizations at 134 °C

- ▶ Para un depósito seguro de los instrumentos sobre el pecho del paciente y sobre el carro de instrumentos
- ▶ Tecnología magnética patentada, sin magnetizar los instrumentos
- ▶ Diseño adaptado al paciente para un provecho óptimo del espacio
- ▶ Autoclavable – silicona blanda garantiza por lo menos 100 esterilizaciones a 134 °C

- ▶ Pour déposer en toute sécurité les instruments sur la poitrine du patient et sur le chariot d'instruments
- ▶ Technologie brevetée, sans magnétiser les instruments
- ▶ Forme adaptée au patient pour une utilisation optimale de l'espace
- ▶ Autoclavable – silicone douce garantit au moins 100 cycles de stérilisation à 134 °C

- ▶ Tenuta sicura degli strumenti sul petto del paziente e sul carrello
- ▶ Tecnologia magnetica brevettata, non lascia tracce di magnetismo sugli strumenti
- ▶ Forma adatta per appoggio sopra il paziente per un ottimo risparmio di spazio
- ▶ Autoclavabile – silicone morbido per minimo 100 cicli di sterilizzazione a 134 °C garantiti

1:4



47.28.00

330 x 235 mm



Kunststoff (autoklavierbar bis 134 °C bei 3 bar)
 Plastic (autoclavable up to 134 °C at 3 bar)
 Plástico (autoclavable hasta 134 °C bajo presión de 3 bar)
 Plastique (autoclavable à 134 °C sous pression de 3 bars)
 Plastica (autoclavabile fino a 134 °C sotto pressione di 3 bar)



L03

Instrumentenpflegeöle und Antibeslagmittel
Instrument Maintenance Oils and Antifog Solutions
Aceites para el mantenimiento de instrumentos y agente antiempañante
Huiles d'entretien des instruments et moyen anti-embuant
Oli di manutenzione per strumenti e liquido antiappannamento

Das Sprühöl eignet sich vorzüglich für Instrumente mit besonders unzugänglichen Bewegungsmechanismen.
 Spraying oil is an excellent lubricant also for instruments with inaccessible moving mechanisms.
 El spray de aceite presta servicios excelentes para instrumentos con articulaciones de acceso difícil.
 Le spray huileux se prête par excellence pour des instruments à mécanisme de mouvement difficilement accessible.
 L'olio spray è adatto per strumenti con articolazioni difficilmente accessibili.



400 ml
46.00.40
 P₁₂

Zum Ölen von Schlüssen, Sperren, Gelenken usw.
 For box locks, ratchets, joints etc.
 Para engrasar los cierres, las cremalleras y las articulaciones, etc.
 Pour huiler les fermetures, les crémaillères, les joints etc.
 Per oliare gli snodi, le cremagliere e le articolazioni ecc.

Kunststoffflasche
 Plastic-bottle
 Botella de plástico
 Bouteille en matière plastique
 Bottiglia di plastica



100 ml
46.00.44
 P₁₂

Antibeslagmittel für Endoskope
 Antifog solution for endoscopes
 Agente antiempañante para endoscopios
 Moyen anti-embuant pour endoscopes
 Liquido antiappannamento per endoscopi



Sprühflasche
 Spray bottle
 Pulverizador
 Flacon
 Bottiglia spray

15 ml
91.10.10



Pipettenflasche
 Pipette bottle
 Botella con pipeta
 Bouteille à pipette
 Bottiglia a pipeta

25 ml
91.10.11



Flasche, steril
 Bottle, sterile
 Botella, estéril
 Bouteille, stérile
 Bottiglia, sterile

30 ml
91.10.12

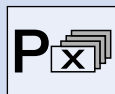

Verpackungseinheit "X" Stück
 Packing unit "X" pieces
 Paquete de "X" unidades
 Emballage de "X" pièces
 Confezione da "X" pezzi



Handelsware
 Merchandise
 Mercancias
 Marchandise
 Merce



Siebvorschläge
Set Suggestions
Proposiciones de juegos
Propositions pour boîtes
Proposte di set

M



Z O B E L

Siebvorschläge
Set Suggestions
Proposiciones de juegos
Propositions pour boîtes
Proposte di set

M01	Rhinoplastik Rhinoplasty Rinoplastia Rhinoplastie Rinoplastica	GUBISCH	277
	Rhinoplastik Rhinoplasty Rinoplastia Rhinoplastie Rinoplastica	DANIEL	282
M02	Ultrafeines mikrochirurgisches Instrumenten-Set Ultra fine micro surgical instrument set Set ultra fino para microcirugia Jeu de microchirurgie ultra-fin Set ultra fino per la microchirurgia	KOSHIMA	285
M03	Gesichts- und Stirnlifting Face and forehead lift Lifting facial y de le trente Lifting facial et frontal Lifting facciale e frontale	SOLZ	286
M04	Blepharoplastik Blepharoplasty Blefaroplastia Blépharoplastie Blefaroplastica	SOLZ	288
	Blepharoplastik Blepharoplasty Blefaroplastia Blépharoplastie Blefaroplastica	GUBISCH	289
M05	Mammoplastik Mammoplasty Mamoplastia Plastie mammaire Plastica mammaria	SOLZ	290
M06	Entnahme von Rippenknorpel Harvesting of costal cartilages Toma de cartilago de costilla Prélèvement de cartilages des côtes Prelievo di cartilagine costale	NAGATA	291
M07	Rippenspanentnahme Rib harvest Extracción de viruta ósea de las costillas Prélèvement de cartilage des côtes Prelievo di truciolo costale	DANIEL-GUBISCH	292
	Rippenspanentnahme Rib harvest Extracción de viruta ósea de las costillas Prélèvement de cartilage des côtes Prelievo di truciolo costale	DANIEL-GUBISCH Rib Harvest Set	294
M08	Aurikular-Rekonstruktion mit Rippenknorpel Auricular reconstruction with costal cartilages Reconstrucción auricular con cartilago de costilla Reconstruction auriculaire avec cartilages des côtes Ricostruzione auricolare con cartilagine costale	NAGATA	295
M09	Abdominoplastik Abdominoplasty Abdominoplastia Abdominoplastie Addominoplastica	SOLZ	297
M10	Präparation von Vollhauttransplantaten Preparation of skin graft Preparación de injertos de piel entera Préparation des greffes de peau entière Preparazione di innesti della cute intera	KASTEN	298
M11	Mikrochirurgie Micro Surgery Microcirugia Microchirurgie Microchirurgia		299

GUBISCH



PART 1

Item number	Description	Quantity
01.22.15	Scalpel blade · figure 15 · sterile · packing unit 100 pieces	1
01.27.07	Scalpel handle · no. 7 · long · 16.5 cm	1
02.27.12	Delicate scissors · straight · 12 cm	1
03.06.13	Operating scissors · straight · sharp/blunt · 13 cm	1
03.57.67	MAYO-STILLE HM Dissecting scissors · curved · 17 cm	1
04.67.14	REYNOLDS (JAMESON) Dissecting scissors · curved · 14 cm	1
06.20.62	ADSON HM Dressing forceps · 12 cm	1
06.23.12	MICRO-ADSON Tissue forceps · 1 × 2 teeth · 12 cm	2
06.25.12	ADSON-BROWN Tissue forceps · 7 × 7 teeth · 12 cm	1
06.45.20	Dressing forceps · serrated · 20 cm	1





M01

Rhinoplastik
Rhinoplasty
Rinoplastía
Rhinoplastie
Rinoplastica

GUBISCH



PART 2

Item number	Description	Quantity
07.19.15	NELSON Tissue grasping forceps · 15 cm	1
07.30.16	GRUENWALD Bayonet forceps · 16 cm	1
10.12.61	GUBISCH HM Needle holder · extra-fine · 12.5 cm	1
10.20.65	CRILE-WOOD HM Needle holder · fine · 15 cm	1
15.40.12	MICRO-HALSTED Hemostatic forceps · straight · 12.5 cm	1
• 15.41.12	MICRO-HALSTED Hemostatic forceps · curved · 12.5 cm	1
15.58.15	LERICHE Hemostatic forceps · straight · 15 cm	1
16.10.14	PEAN Hemostatic forceps · straight · 14 cm	2
17.55.13	BACKHAUS Towel clamp · 13 cm	1
19.09.17	Dressing forceps · curved · 17.5 cm	1
19.17.20	GROSS Dressing forceps · curved · 20 cm	1
20.35.01	BARSKY Skin hook · 1 tooth · 15 cm	2
20.50.05	JOSEPH Delicate retractor · 2 teeth · 17 cm	1
20.52.10	GUTHRIE Delicate retractor · 2 teeth · sharp · 13 cm	1
26.29.07	LANGENBECK Elevator · thin · 7 mm · 20 cm	1
26.35.01	FREER Raspatory · sharp/sharp · 5 mm · 19 cm	1
26.42.05	WILLIGER Raspatory · 5 mm · 16 cm	1
26.42.23	McKENTY Raspatory · 3 mm · 15 cm	1
• 26.42.24	McKENTY Raspatory · 4 mm · 15 cm	1
27.10.41	Mallet · made of Novotex plastic · Ø 50 mm · 226 g · 25 cm	1
44.90.70	GUBISCH Pen holder · 13 cm	1
44.90.72	Pen · for pen holder 44.90.70 · packing unit 10 pieces	1
47.31.01	Round bowl · Ø 40 mm · height 20 mm · 0.02 l	1
• 47.31.02	Round bowl · Ø 60 mm · height 30 mm · 0.06 l	1
• 47.31.04	Round bowl · Ø 80 mm · height 40 mm · 0.16 l	1
• 47.31.06	Round bowl · Ø 110 mm · height 55 mm · 0.40 l	1



Instrumente, optional
Instruments, optional
Instrumentos, opcional
Instruments, optionnel
Strumenti, opzionale

GUBISCH



PART 3

Item number	Description	Quantity
60.00.40	CASTROVIEJO Caliper · measuring range 20 mm · 8 cm	1
60.05.12	DESMARRES Lid retractor · figure 2 · 14 cm	1
63.45.11	Surgical hand piece · with irrigation tube · 11 cm	1
63.56.20	Cutting burr · barrel style · Ø 5 mm · shank Ø 2.35 mm · 7 cm	1
66.08.59	KILLIAN Nasal speculum · figure 4 · 90 mm · dismantable · 14 cm	1
66.28.03	WEIL-BLAKESLEY Nasal forceps · straight · 4.2 mm · 12 cm	1
66.52.10	FREER Mucosa knife · 16 cm	1
67.03.52	COTTLE Nasal speculum · 50 mm · 13 cm	1
67.15.98	HARALDSSON Suction elevator · Ø 3 mm · 18.5 cm	1
67.16.70	DANIEL Spina nasalis awl · 16 cm	1
67.19.76	Cartilage cutting block made of PPSU	1
67.19.79	Cartilage cutting block made of Aluminium	1
67.19.80	COTTLE Cartilage crusher	1
67.19.81	“Dicing Block” made of Propylux · 120 × 120 × 15 mm	1
67.20.07	GUBISCH-KILNER Alar retractor · 10 mm · 8 cm	1
67.21.32	GUBISCH-AUFRICHT Nasal retractor · 17 cm · 30 × 6/10 mm	1
• 67.21.33	GUBISCH-AUFRICHT Nasal retractor · 17 cm · 50 × 6/12 mm	1
67.30.15	COTTLE-GUBISCH Chisel · graduated · hollow cut · 5 mm · 18 cm	1
67.30.22	COTTLE-GUBISCH Chisel · graduated · hollow cut · 12 mm · 18 cm	1



Instrumente, optional
Instruments, optional
Instrumentos, opcional
Instruments, optionnel
Strumenti opzionale



M01

Rhinoplastik
Rhinoplasty
Rinoplastía
Rhinoplastie
Rinoplastica

GUBISCH



67.30.52



67.33.03



67.53.71



67.58.42



67.61.00



67.61.01



67.61.03

67.61.11
67.61.14

67.65.72



68.61.03



72.00.18

PART 4

Item number	Description	Quantity
67.30.52	GUBISCH Osteotome · with aluminium handle · 2 mm · 20 cm	1
• 67.30.53	GUBISCH Osteotome · with aluminium handle · 3 mm · 20 cm	1
67.33.03	FANOUS-GUBISCH Osteotome · with thorn · 4 mm · 19.5 cm	1
67.53.71	CAPLAN Nasal septum scissors · angled · 20 cm	1
67.58.42	AIACH-GUBISCH Forceps · 16 cm	1
• 67.58.44	AIACH-GUBISCH Forceps · 16 cm	1
67.61.00	Handle for nasal rasps · 14 cm	1
67.61.01	Handle for nasal rasps · double-ended · 14 cm	1
67.61.03	Wrench · for nasal rasps	1
67.61.11	Rasps insert HM · figure 2	1
67.61.14	Rasps insert HM · figure 5	1
• 67.61.10	Rasps insert HM · figure 1	1
• 67.61.12	Rasps insert HM · figure 3	1
• 67.61.13	Rasps insert HM · figure 4	1
• 67.61.15	Rasps insert HM · figure 6	1
• 67.61.16	Rasps insert HM · figure 7	1
• 67.61.17	Rasps insert HM · figure 8	1
• 67.61.18	Rasps insert HM · figure 9	1
• 67.61.19	Rasps insert HM · figure 10	1
67.65.71	Protective guard	1
67.65.72	GUBISCH-RUBIN HM Septal morselizar · 20 cm	1
68.61.03	LINDEMANN Cutting burr · shank-Ø 2.35 mm · 45 mm	1
• 68.61.05	LINDEMANN Cutting burr · shank-Ø 2.35 mm · 44.5 mm · Ø 1.4 mm	1
• 68.61.06	LINDEMANN Cutting burr · shank-Ø 2.35 mm · 70 mm · Ø 1.4 mm	1
72.00.18	BUCHWALD Tongue spatula · 18/23 mm · 18 cm	1

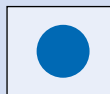

GUBISCH

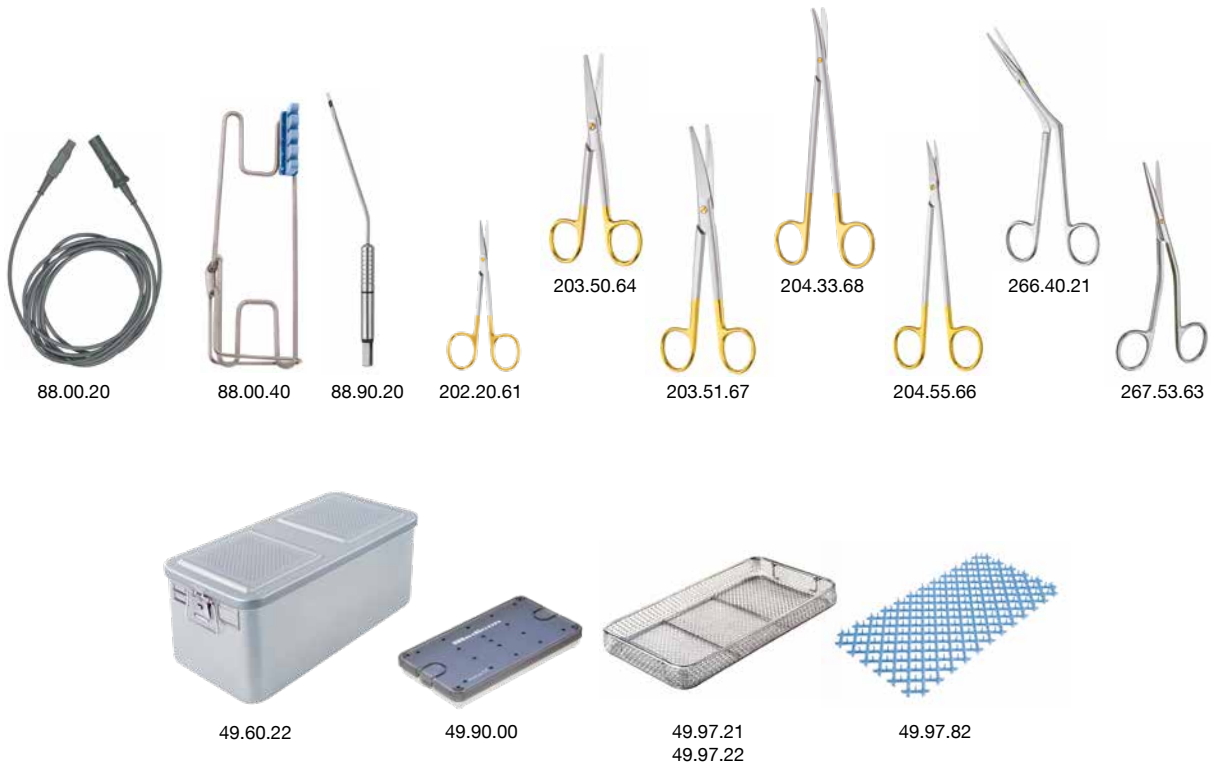

PART 5

Item number	Description	Quantity
88.00.20	Bipolar connecting cable · 3 m long · Ø 12.5 mm	1
• 88.00.21	Bipolar connecting cable · 5 m long · Ø 12.5 mm	1
• 88.00.22	Bipolar connecting cable · 3 m long · Ø 4 mm	1
• 88.00.23	Bipolar connecting cable · 3 m long · Ø 8 mm	1
• 88.00.24	Bipolar connecting cable · 5 m long · Ø 8 mm	1
• 88.00.27	Bipolar connecting cable · 5 m long · Ø 4 mm	1
88.00.40	Bracket for one HF cable · with buckling resistance · 22.5 cm	1
88.90.20	BINNER Coagulation electrode · bipolar · 18.5 cm	1
202.20.61	SC Plus iris scissors straight · 11.5 cm	1
203.50.64	MAYO Dissecting scissors · supercut plus · straight · 14 cm	1
203.51.67	MAYO Dissecting scissors · supercut plus · curved · 17 cm	1
204.33.68	METZENBAUM Dissecting scissors · supercut plus · curved · 18 cm	1
204.55.66	KELLY Dissecting scissors · supercut plus · curved · 16 cm	1
266.40.21	HEYMANN Rhinoplasty scissors · supercut · 18 cm	1
267.53.63	FOMON Rhinoplasty scissors · supercut plus · angled downwards · 13 cm	1
49.60.22	Medicontainer · 590 × 290 × 220 mm · silver	1
49.90.00	Tray · with silicone mat · 190 × 102 × 19 mm	1
49.97.21	Wire basket · 510 × 255 × 50 mm	1
49.97.22	Wire basket · 510 × 255 × 70 mm	2
49.97.82	Silicon mat · 13 mm · 467 × 240 mm	3





M01

Rhinoplastik
Rhinoplasty
Rinoplastía
Rhinoplastie
Rinoplastica

DANIEL

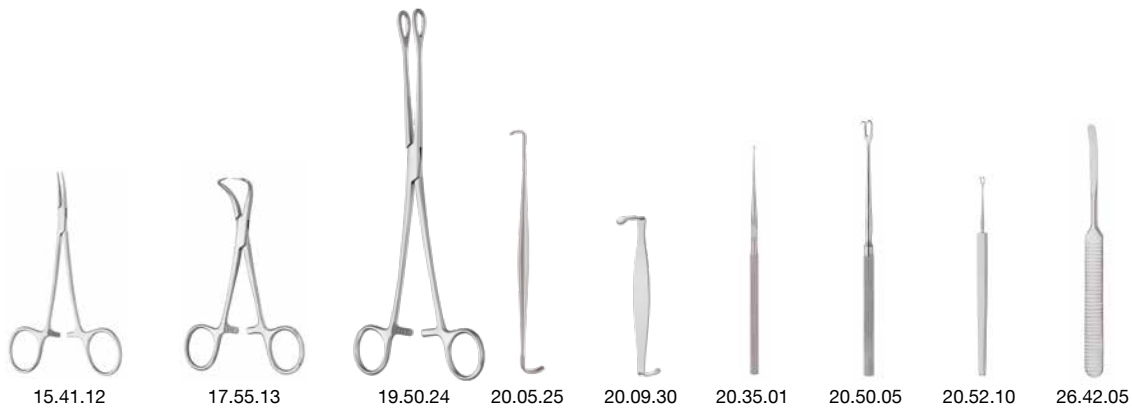
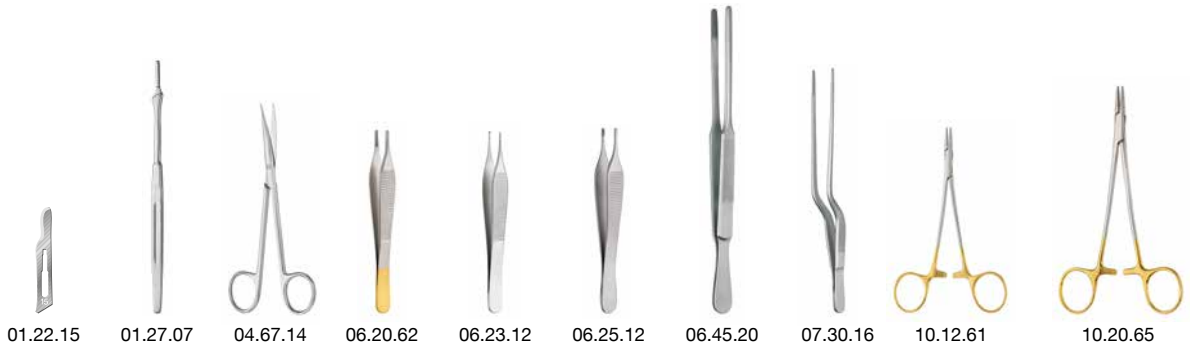

PART 1

Item number	Description	Quantity
01.22.15	Scalpel blade · figure 15 · sterile · packing unit 100 pieces	1
01.27.07	Scalpel handle · no. 7 · long · 16.5 cm	1
04.67.14	REYNOLDS (JAMESON) Scissors · curved · 14 cm	1
06.20.62	ADSON HM Dressing forceps · 12 cm	1
06.23.12	MICRO-ADSON Tissue forceps · 1 × 2 teeth · 12 cm	2
06.25.12	ADSON-BROWN Tissue forceps · 7 × 7 teeth · 12 cm	1
06.45.20	Dressing forceps · serrated · 20 cm	1
07.30.16	GRUENWALD Dressing forceps · 16 cm	1
10.12.61	GUBISCH HM Needle holder · fine · 12.5 cm	1
10.20.65	CRILE-WOOD HM (DEBAKEY HM) Needle holder · fine · 15 cm	1
15.41.12	MICRO-HALSTED Hemostatic forceps · curved · 12.5 cm	2
17.55.13	BACKHAUS Towel clamp · 13 cm	3
19.50.24	FOERSTER Sponge forceps · straight · 24 cm	2
20.05.25	RAGNELL Delicate retractor · double-ended · 16 cm	2
20.09.30	CRILE Retractor · double-ended · 11 cm	1
20.35.01	BARSKY Skin hook · 1 tooth · 15 cm	1
20.50.05	JOSEPH Delicate retractor · 2 teeth · sharp · 17 cm	2
20.52.10	GUTHRIE Delicate retractor · 2 teeth · sharp · 13 cm	2
26.42.05	WILLIGER Raspatory · 5 mm · 16 cm	1



DANIEL



PART 2

Item number	Description	Quantity
26.42.23	McKENTY Raspatory · 3 mm · 15 cm	1
26.44.04	JOSEPH Raspatory · 4 mm · slightly curved · 16 cm	1
27.10.41	Mallet · made of Novotex plastic · Ø 50 mm · 226 g · 25 cm	1
44.37.15	Ruler · graduated in mm and inches · 15 cm	1
47.31.02	Round bowl · Ø 60 mm · height 30 mm · 0.06 l	1
• 47.31.06	Round bowl · Ø 110 mm · height 55 mm · 0.40 l	1
47.50.50	Medicine cup · graduated · 50 cc	1
60.00.40	CASTROVIEJO Caliper · measuring range 20 mm · 8 cm	1
67.03.52	COTTLE Nasal specula · 50 mm · 13 cm	1
67.15.98	HARALDSSON Suction elevator · Ø 3mm · 18.5 cm	1
67.16.27	DANIEL-CAKIR Subperichondrial/subperiosteal elevator · 20 cm	1
67.16.29	COTTLE-DANIEL Septal elevator · 21 cm	1
67.16.70	DANIEL Spina nasalis awl · 16 cm	1
67.19.77	Cartilage cutting block with grid · Propylux	1
67.19.80	GUBISCH Cartilage crusher · 65 × 30 mm	1
67.20.07	GUBISCH-KILNER Alar retractor · 10 mm · 8 cm	1
67.21.46	AUFRICHT-DANIEL Nasal retractor · 11 cm	1
67.30.52	GUBISCH Osteotome · straight · 2 mm · 18.5 cm	1
• 67.30.53	GUBISCH Osteotome · straight · 3 mm · 18.5 cm	1
67.30.60	CAKIR Osteotome · straight · without guide	1
67.33.03	FANOUS-GUBISCH Osteotome · with guide · 3 mm · 19.5 cm	1



Instrumente, optional
Instruments, optional
Instrumentos, opcional
Instruments, optionnel
Strumenti opzionale

**M01**

Rhinoplastik
Rhinoplasty
Rinoplastía
Rhinoplastie
Rinoplastica

DANIEL

67.58.42



67.61.01



67.61.03



67.61.14



203.50.67



214.52.15



277.53.90



49.60.22

49.97.21
49.97.22

49.97.82

PART 3

Item number	Description	Quantity
67.58.42	AIACH-GUBISCH Forceps · 16 cm	1
67.61.01	Handle for nasal rasps · double-ended · 14 cm	1
67.61.03	Wrench · for nasal rasp	1
67.61.14	HM Nasal rasps · figure 5	1
• 67.61.15	HM Nasal rasps · figure 6	1
203.50.67	MAYO Dissecting scissors · supercut plus · straight · 17 cm	1
214.52.15	DANIEL Dissecting scissors · black line · straight · 15 cm	1
• 214.53.15	JOSEPH-DANIEL Dissecting scissors · black line · curved · blunt · 15 cm	1
• 214.53.16	JOSEPH-DANIEL Dissecting scissors · black line · curved · sharp · 15 cm	1
277.53.90	CONVERSE-DANIEL Dissecting scissors · black line · blunt · 9.5 cm	1
49.60.22	MEDICONTAINER · silver anodized · with paper filter · 590 × 290 × 220 mm	1
49.97.21	Wire basket · 510 × 255 × 50 mm	1
49.97.22	Wire basket · 510 × 255 × 70 mm	2
49.97.82	Silicone mat · distance between naps 13 mm · 467 × 240 mm	3



Ultrafeines mikrochirurgisches Instrumenten-Set
Ultra Fine Micro Surgical Instrument Set
Set ultra fino para microcirugía
Jeu de microchirurgie ultra-fin
Set ultra fino per la microchirurgia

M02

KOSHIMA



56.10.00
KOSHIMA SET

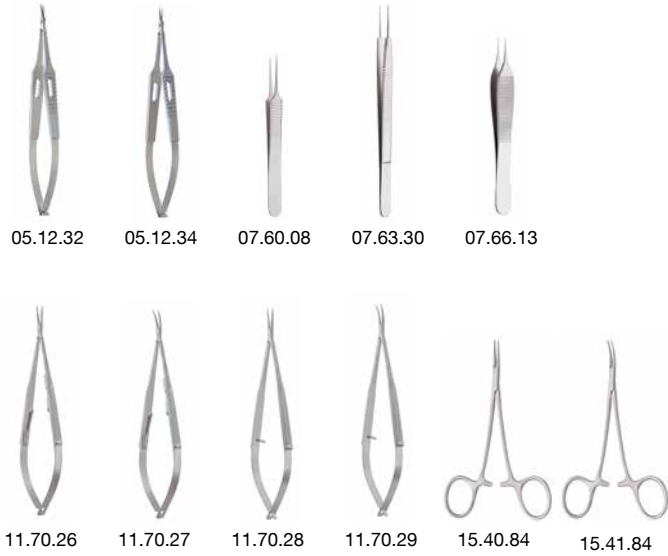

05.12.32 05.12.34 07.60.08 07.63.30 07.66.13
 11.70.26 11.70.27 11.70.28 11.70.29 15.40.84 15.41.84



49.40.35



49.97.71

Item number	Description	Quantity
56.10.00	KOSHIMA Micro instrument set · complete	1
	Consisting of:	
05.12.32	KOSHIMA Micro scissors · curved · vannas-type cutting edges · 15 cm	1
05.12.34	KOSHIMA Micro scissors · straight · vannas-type cutting edges · 15 cm	1
07.60.08	KOSHIMA Micro forceps · 11 cm	1
07.63.30	MICRO 2000 (KOSHIMA) Micro forceps · 14 cm	1
07.66.13	JACOBSON-ADSON (KOSHIMA) Micro forceps · 12 cm	1
11.70.26	CASTROVIEJO (KOSHIMA) Micro needle holder · straight · with catch · 14.5 cm	1
11.70.27	CASTROVIEJO (KOSHIMA) Micro needle holder · curved · with catch · 14.5 cm	1
11.70.28	CASTROVIEJO (KOSHIMA) Micro needle holder · straight · 14.5 cm	1
11.70.29	CASTROVIEJO (KOSHIMA) Micro needle holder · curved · 14.5 cm	1
15.40.84	MICRO-JACOBSON (KOSHIMA) Hemostatic forceps · straight · 12.5 cm	1
15.41.84	MICRO-JACOBSON (KOSHIMA) Hemostatic forceps · curved · 12.5 cm	1
49.40.35	Medicontainer · 300 × 135 × 47 mm · silver	1
49.97.71	Silicon mat · 3 mm · 275 x 125 mm	1

**M03**

Gesichts- und Stirnlifting
Face and Forehead Lift
Lifting facial y de la frente
Lifting facial et frontal
Lifting facciale e frontale

SOLZ**PART 1**

Item number	Description	Quantity
01.22.15	Scalpel blade · figure 15 · sterile · packing unit 100 pieces · sterile	1
01.27.07	Scalpel handle · no. 7 · long · 16.5 cm	1
06.23.12	MICRO-ADSON Tissue forceps · 1 × 2 teeth · 12 cm	1
06.25.12	ADSON-BROWN Tissue forceps · 7 × 7 teeth · 12 cm	1
06.35.60	SELECT Tissue forceps · 1 × 2 teeth · 20 cm	1
09.87.07	Liposuction cannula · Ø 3.0 mm · three holes · diagonal · 20 cm	1
09.88.46	Handle for cannula · with hole · tube connection · rotatable · 13 cm	1
10.12.61	GUBISCH HM Needle holder · extra-fine · 12.5 cm	1
10.20.64	BABY CRILE-WOOD HM Needle holder · fine · 15 cm	1
17.55.08	BACKHAUS Towel clamp · 8.5 cm	6
20.30.19	GILLIES Delicate retractor · 1 tooth · 19 cm	1
20.50.05	JOSEPH Delicate retractor · 2 teeth · 17 cm	1
22.10.12	FARABEUF-BABY Retractor · double-ended · 10/12 mm · 12 cm	1
22.20.04	WALTER Retractor · double-ended · 19 cm	1
23.25.13	LANGENBECK-KOCHER Retractor · 15 × 80 mm · 21 cm	2
24.90.60	SOLZ Racket retractor · 45 × 100 mm · 12.5 cm	2
53.13.14	DEMARTEL Scalp flap forceps · 14 cm	1



SOLZ



67.93.30



202.21.12



203.50.14



204.79.20



49.60.17



49.95.75



49.97.21
49.97.22

PART 2

Item number	Description	Quantity
67.93.30	PITANGUY Facelift marker · 16 cm	1
202.21.12	Iris scissors · supercut · curved · 12.5 cm	1
203.50.14	MAYO Dissecting scissors · supercut · straight · 14 cm	1
204.79.20	SOLZ Dissecting scissors · supercut · curved · 20 cm	1
• 214.79.20	SOLZ Dissecting scissors · supercut · curved · 20 cm	1
49.60.17	Medicontainer · 590 x 290 x 170 mm · silver	1
49.95.75	Wrapping drape · 160 x 80 cm · polyester · green	1
49.97.21	Wire basket · 510 x 255 x 50 mm	1
49.97.22	Wire basket · 510 x 255 x 70 mm	1



**M04**

Blepharoplastik
Blepharoplasty
Blefaroplastia
Blépharoplastie
Blefaroplastica

SOLZ

Item number	Description	Quantity
01.22.15	Scalpel blade · figure 15 · sterile · packing unit 100 pieces	1
01.27.03	Scalpel handle · no. 3 · 12.5 cm	1
02.50.02	STEVENS Delicate scissors · straight · sharp · 11.5 cm	1
02.50.03	STEVENS Delicate scissors · curved · sharp · 11.5 cm	1
06.20.12	ADSON Dressing forceps · serrated · 12 cm	1
06.21.12	ADSON Dressing forceps · serrated · 12cm	1
10.08.12	NEIVERT Needle holder · smooth · 12.5 cm	1
15.44.12	HALSTED-MOSQUITO Hemostatic forceps · straight · 12.5 cm	1
15.45.12	HALSTED-MOSQUITO Hemostatic forceps · curved · 12.5 cm	1
17.55.08	BACKHAUS Towel clamp · 8.5 cm	4
20.30.19	GILLIES Delicate retractor · 1 tooth · 19 cm	1
20.50.05	JOSEPH Delicate retractor · 2 teeth · 17 cm	1
20.65.02	JOSEPH Delicate retractor · 2 teeth · blunt · 16 cm	1
60.05.11	DESMARRES Lid retractor · figure 1 · 9 x 12 mm · 13 cm	1
203.50.14	MAYO Dissecting scissors · supercut · straight · 14 cm	1
49.50.13	Medicontainer · 290 x 290 x 135 mm · silver	1
49.95.73	Wrapping drape · 80 x 90 cm · polyester · green	1
49.97.03	Wire basket · 240 x 255 x 100 mm	1





GUBISCH

Blepharoplastik
Blepharoplasty
Blefaroplastia
Blépharoplastie
Blefaroplastica

M04

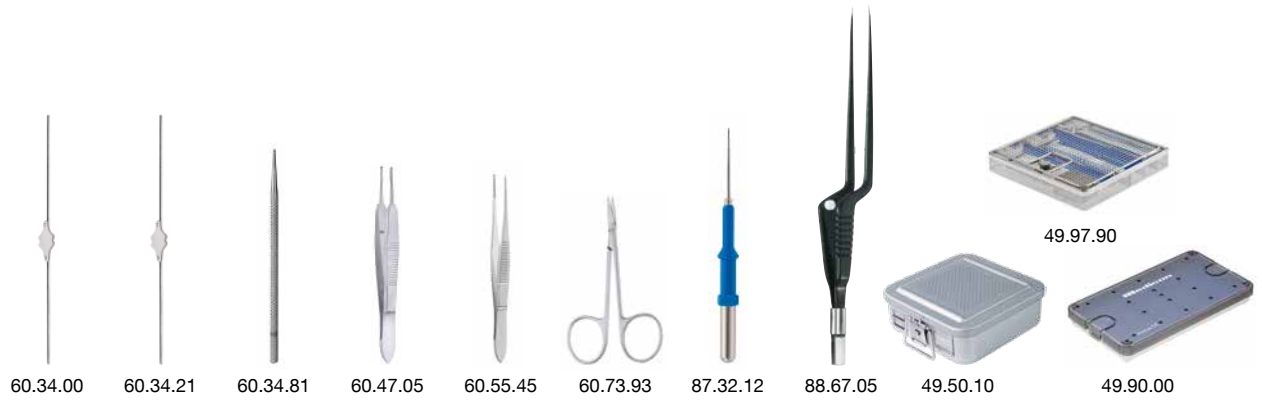
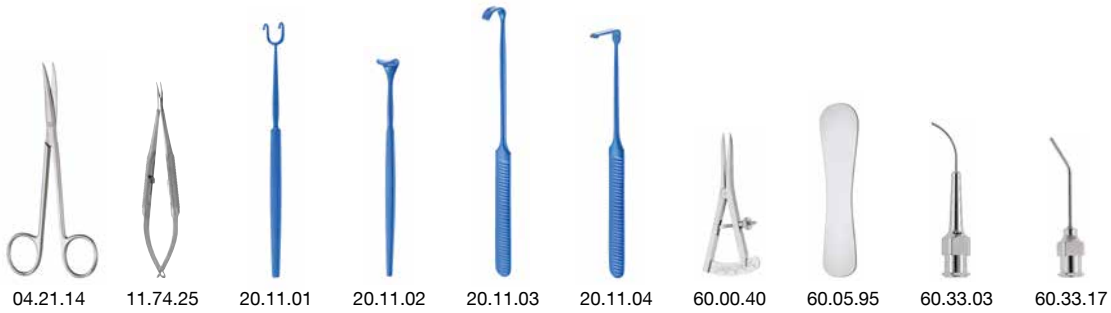

Item number	Description	Quantity
04.21.14	BROPHY (Sullivan) Delicate dissecting scissors · curved · sharp · 14 cm	1
11.74.25	BARRAQUER Micro needle holder · round handle Ø 8 mm · plain · 14 cm	1
20.11.01	FOMON Alar retractor · 17 cm	1
20.11.02	DESMARRES Lid retractor · 14 cm	1
20.11.03	STRANDELL-STILLE Retractor · 6 x 18 mm · serrated · 19 cm	2
20.11.04	LANGENBECK-GREEN Retractor · 6 x 25 mm · serrated · 17 cm	1
60.00.40	CASTROVIEJO Caliper · 20 mm · 8 cm	1
60.05.95	JAEGER Lid plate · 11 cm	1
60.33.03	ANEL Tear duct cannulas · 23 Gauge · Luer-Lock · 4 cm	1
60.33.17	MOD. BONN Irrigation cannula · 19 Gauge · 3.5 cm	1
60.34.00	BOWMAN Lacrimal probe · figure 0000-000 · 13 cm	1
60.34.21	BOWMAN (Williams) Lacrimal probe · figure 00-0 · 13 cm	1
60.34.81	WILDER Lacrimal dilator · figure 1 · 11 cm	1
• 60.34.82	WILDER Lacrimal dilator · figure 2 · 11 cm	1
60.47.05	CASTROVIEJO Suturing forceps · 0.5 mm · 1 x 2 teeth · 10 cm	1
60.55.45	GUBISCH Blepharoplasty forceps · 10 cm	1
60.73.93	MOD. BONN Iris scissors · curved · 9 cm	1
87.32.12	Needle electrode · straight · Ø 4 mm	1
• 87.33.12	Needle electrode · straight · Ø 2.4 mm	1
88.67.05	Coagulation forceps bipolar · sharp · 16.5 cm	1
49.50.10	Medicontainer · 290 x 290 x 100 mm	1
49.90.00	Tray · 190 x 102 x 19 mm · with silicone mat	1
49.97.90	Wire basket · 240 x 250 x 40 mm · with arrangement	1



Instrumente, optional
 Instruments, optional
 Instrumentos, opcional
 Instruments, optionnel
 Strumenti opzionale

**M05**

Mammoplastik
Mammoplasty
Mamoplastia
Plastie mammaire
Plastica mammaria

SOLZ

Item number	Description	Quantity
01.22.15	Scalpel blade · figure 15 · sterile · packing unit 100 pieces	1
01.27.07	Scalpel handle · no. 7 · long · 16.5 cm	1
02.07.13	JABALEY Delicate scissors · standard · curved · 13 cm	1
04.33.20	METZENBAUM Dissecting scissors · curved · 20 cm	1
06.23.12	MICRO-ADSON Tissue forceps · 1 x 2 teeth · 12 cm	1
07.30.19	GRUENWALD Bayonet forceps · 19.5 cm	1
10.20.14	BABY CRILE-WOOD Needle holder · fine · 15 cm	1
10.20.64	BABY CRILE-WOOD HM Needle holder · fine · 15 cm	1
22.10.12	FARABEUF-BABY Retractor · double-ended · 10/12 mm · 12 cm	1
23.25.13	LANGENBECK-KOCHER Retractor · 15 x 80 mm · 21 cm	1
24.90.10	SOLZ Non-traumatical breast dissector · 34 cm	1
24.90.11	SOLZ Non-traumatical breast dissector · 37 cm	1
24.90.15	SOLZ Hook dissector · right angled · 36 cm	1
24.90.16	SOLZ Hook dissector · left angled · 36 cm	1
24.90.20	SOLZ Areola marker · blunt · Ø 36 mm	1
24.90.25	SOLZ Areola marker · blunt · Ø 40 mm	1
24.90.30	SOLZ Areola marker · blunt · Ø 42 mm	1
24.90.35	SOLZ Areola marker · blunt · Ø 45 mm	1
24.90.40	MARX Breast retractor · 125 x 30 mm · 27 cm	1
• 24.90.45	MARX Breast retractor · 140 x 30 mm · 27 cm	1
47.31.02	Bowl for marking colour · 0.06 l · Ø 6 cm	1
202.07.13	JABALEY Delicate scissors · supercut · curved · 13 cm	1
204.79.20	SOLZ Dissecting scissors · supercut · curved · 20 cm	1
• 214.79.20	SOLZ Dissecting scissors · supercut · curved · 20 cm	1
49.60.17	Medicontainer · 590 x 290 x 170 mm · silver	1
49.95.75	Wrapping drape · 160 x 80 cm · polyester · green	1
49.97.21	Wire basket · 510 x 255 x 50 mm	1
49.97.22	Wire basket · 510 x 255 x 70 mm	1



Instrumente, optional
 Instruments, optional
 Instrumentos, opcional
 Instruments, optionnel
 Strumenti, opzionale

Entnahme von Rippenknorpel
Harvesting of Costal Cartilages
Toma de cartilago de costilla
Prélèvement de cartilages des côtes
Prelievo di cartilagine costale

M06

NAGATA



Item number	Description	Quantity
06.40.15	McINDOE Dressing forceps · 15 cm	1
06.40.85	GILLIES Tissue forceps · 1 × 2 teeth · 15 cm	1
20.05.09	SENN-MILLER Delicate retractor · double-ended · blunt · 16 cm	2
20.07.08	JACKSON Delicate retractor · double-ended · blunt · 18 cm	2
20.50.01	JOSEPH Delicate retractor · 16 cm	1
23.06.10	LANGENBECK Retractor · 10 × 40 mm · 21 cm	2
23.06.13	LANGENBECK Retractor · 13 × 42 mm · 21 cm	2
23.21.02	KOCHER Retractor · 12 × 60 mm · 21 cm	2
26.37.95	COHEN Elevator · double-ended · 5 mm · 24 cm	1
66.54.50	PENNINGTON Septum elevator · double-ended · 20 cm	1
68.09.05	DINGMAN Raspatory · double-ended · 18 cm	1
203.51.14	MAYO Delicate scissors · supercut · curved · 14 cm	1
49.50.10	Medicontainer · 290 × 290 × 100 mm · silver	1
49.92.75	Identification label · red · engraved "NAGATA COSTAL CARTILAGES"	1
49.95.73	Wrapping drape · 80 x 90 cm · polyester · green	1
49.97.02	Wire basket · 240 × 255 × 50 mm	1
49.97.77	Silicon mat · distance between naps 8 mm · 240 × 220 mm	1

**M07**

Rippenspanentnahme
Rib Harvest Set
Extracción de viruta ósea de las costillas
Prélèvement de cartilage des côtes
Prelievo di truciolo costale

DANIEL-GUBISCH**PART 1**

Item number	Description	Quantity
01.22.10	Scalpel blade · figure 10 · sterile · packing unit 100 pieces	1
01.27.03	Scalpel handle · no. 3 · standard · 12.5 cm	1
03.06.14	Operating scissors · straight · sharp/blunt · 14.5 cm	1
06.07.14	Tissue forceps · straight · slim · 1 x 2 teeth · 14.5 cm	1
06.25.12	ADSON-BROWN Tissue forceps · straight · 7 x 7 teeth · 12 cm	1
07.15.15	Russian tissue forceps · 15 cm	1
10.18.68	MAYO-HEGAR HM Needle holder · 18 cm	1
20.12.75	STRANDELL-STILLE Retractor · 6 x 15 mm · 17 cm	2
20.60.03	Retractor · 3 teeth · 8 mm · 17 cm	2
22.18.21	PARKER-LANGENBECK (US ARMY) Retractor · double-ended · 21 cm · set/2	1
22.18.22	PARKER-LANGENBECK (US ARMY) Retractor · double-ended · serrated · 21 cm · set/2	1
26.48.10	DANIEL-GUBISCH Raspatory · 6 mm · sharp · slight curved · 17.5 cm	1
26.48.12	DANIEL-GUBISCH Raspatory · 6 mm · sharp · medium curved · 17 cm	1
26.48.14	DANIEL-GUBISCH Raspatory · 6 mm · sharp · strong curved · 16 cm	1
47.31.02	Round bowl · Ø 60 mm · height 30 mm · 60 ml	1
47.31.04	Round bowl · Ø 80 mm · height 40 mm · 160 ml	1
47.31.06	Round bowl · Ø 110 mm · height 55 mm · 400 ml	1
54.30.05	DANIEL-GUBISCH Rib raspatory · right · 5 mm · sharp · 17 cm	1
54.30.06	DANIEL-GUBISCH Rib raspatory · left · 5 mm · sharp · 17 cm	1



DANIEL-GUBISCH

Rippenspanentnahme
Rib Harvest Set
Extracción de viruta ósea de las costillas
Prélèvement de cartilage des côtes
Prelievo di truciolo costale

M07



PART 2

Item number	Description	Quantity
67.16.25	DANIEL-GUBISCH Raspatory · double-ended · 4 mm · sharp/abrasive · 21.5 cm	1
87.32.00	Knife electrode · straight · Ø 4 mm	1
• 87.33.00	Knife electrode · Ø 2.4 mm	1
88.00.20	Bipolar cable · Ø 12.5 mm · 3 m	1
88.70.16	Bipolar forceps · bayonet · 2 mm · blunt · 19 cm	1
204.55.66	KELLY Dissecting scissors · supercut plus · curved · 16 cm	1
49.60.10	Medicontainer · 590 x 290 x 100 mm · silver	1
49.95.75	Wrapping drape · 160 x 80 cm · polyester · green	1
49.97.21	Wire basket · 510 x 255 x 50 mm	1



Instrumente, optional
 Instruments, optional
 Instrumentos, opcional
 Instruments, optionnel
 Strumenti opzionale

**M07**

Rippenspanentnahme
Rib Harvest Set
Extracción de viruta ósea de las costillas
Prélèvement de cartilage des côtes
Prelievo di truciolo costale

DANIEL-GUBISCH
Rib Harvest Set

21
20
19
18
17
16
15
14
13
12
11
10
9
8
7
6
5
4
3
2
1
cm | inch

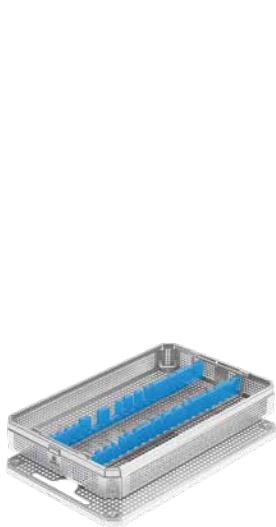

49.90.06



Satz komplett
 Set complete
 Set completo
 Set complet
 Set completo

bestehend aus:
 consisting of:
 compuesto por:
 consisten en:
 costituito da:

54.30.10

07.15.15	Russian tissue forceps · 15 cm	1
20.12.75	STRANDELL-STILLE Retractor · 6 x 15 mm · 17 cm	2
20.60.03	Retractor · 3 teeth · 8 mm · 17 cm	2
22.18.21	PARKER-LANGENBECK (US ARMY) Retractor · double-ended · 21 cm · set/2	1
22.18.22	PARKER-LANGENBECK (US ARMY) Retractor · double-ended · serrated · 21 cm · set/2	1
26.48.10	DANIEL-GUBISCH Raspatory · 6 mm · sharp · slight curved · 17.5 cm	1
26.48.12	DANIEL-GUBISCH Raspatory · 6 mm · sharp · medium curved · 17 cm	1
26.48.14	DANIEL-GUBISCH Raspatory · 6 mm · sharp · strong curved · 16 cm	1
54.30.05	DANIEL-GUBISCH Rib raspatory · right · 5 mm · sharp · 17 cm	1
54.30.06	DANIEL-GUBISCH Rib raspatory · left · 5 mm · sharp · 17 cm	1
67.16.25	DANIEL-GUBISCH Raspatory · double-ended · 4 mm · sharp/abrasive · 21.5 cm	1
49.90.06	Tray (without instruments)	1



M08

NAGATA

Aurikular-Rekonstruktion mit Rippenknorpel
Auricular Reconstruction with Costal Cartilages
Reconstrucción auricular con cartilago de costilla
Reconstruction auriculaire avec cartilages costaux
Ricostruzione auricolare con cartilagine costale



PART 1

Item number	Description	Quantity
01.97.01	NAGATA Sculptur knife handle · small · 12 cm	1 2
01.97.02	NAGATA Sculptur knife handle · large · 12 cm	1 2
01.97.04	NAGATA Sculptur knife blade · 3.0 mm · 8 cm	1 2
01.97.05	NAGATA Sculptur knife blade · 4.5 mm · 8 cm	1 2
01.97.06	NAGATA Sculptur knife blade · 6.0 mm · 8.5 cm	1 2
06.20.12	ADSON Dressing forceps · serrated · 12 cm	1 2
06.21.12	ADSON Tissue forceps · 1 × 2 teeth · 12 cm	1 2
06.40.15	McINDOE Dressing forceps · serrated · 15 cm	1 1
06.40.85	GILLIES Tissue forceps · 1 × 2 teeth · 15 cm	1 1
10.09.61	NAGATA HM Needle holder · smooth · 11.5 cm	1 2
10.09.63	NAGATA HM Needle holder · smooth · 13 cm	1 2
11.20.67	MATHIEU HM Needle holder · regular · 17 cm	1 2
14.23.62	UNIVERSAL HM Wire cutting scissors · serrated cutting edge · 12 cm	1 2
14.40.65	NIRO HM Wire twisting forceps · 15 cm	1 2
14.70.10	Fixation wire with needles · packing unit 20 pieces · sterile · 15 cm	1 2
15.45.12	HALSTED-MOSQUITO Hemostatic forceps · curved · 12.5 cm	1 2

Basic set
 Deluxe set



**M08**

Aurikular-Rekonstruktion mit Rippenknorpel
Auricular Reconstruction with Costal Cartilages
Reconstrucción auricular con cartilago de costilla
Reconstruction auriculaire avec cartilages costaux
Ricostruzione auricolare con cartilagine costale

NAGATA

26.29.01



26.29.02



54.30.11



54.30.12



202.40.12



202.41.12



49.50.13



49.95.75

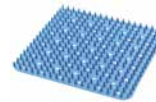

49.97.77



49.97.02

PART 2

Item number	Description	Quantity
26.29.01	NAGATA Septum elevator · blunt · double-ended · 16 cm	1 1
26.29.02	NAGATA Septum elevator · blunt · double-ended · 17 cm	1 1
54.30.11	DOYEN Rip raspator · right · 17 cm	1 1
54.30.12	DOYEN Rip raspator · left · 17 cm	1 1
202.40.12	Delicate dissecting scissors · supercut · straight · 12 cm	1 2
202.41.12	Delicate dissecting scissors · supercut · curved · 12 cm	1 2
49.50.13	Medicontainer · 290 x 290 x 135 mm · silver	1 1
49.92.76	Identification label · red · engraved "NAGATA BASIC"	1
49.92.77	Identification label · red · engraved "NAGATA DELUXE"	1
49.95.73	Wrapping drape · 80 x 90 cm · polyester · green	1 1
49.97.02	Wire basket · 240 x 255 x 50 mm	1 2
49.97.77	Silicon mat · distance between naps 8 mm · 240 x 220 mm	1 2

Basic set

Deluxe set





SOLZ

Abdominoplastik
Abdominoplasty
Abdominoplastia
Abdominoplastie
Addominoplastica

M09

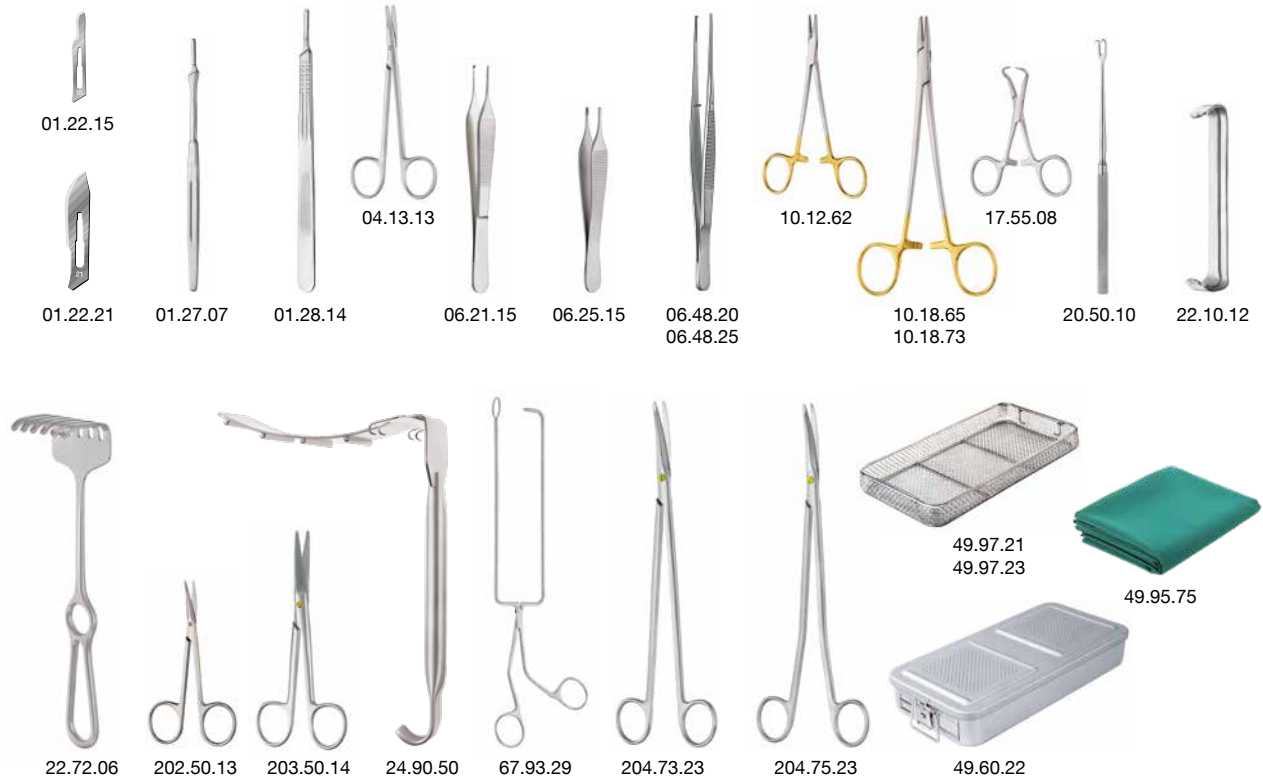

Item number	Description	Quantity
01.22.15	Scalpel blade · figure 15 · sterile · packing unit 100 pieces	1
01.22.21	Scalpel blade · figure 21 · sterile · packing unit 100 pieces	1
01.27.07	Scalpel handle · no. 7 · long · 16.5 cm	1
01.28.14	Scalpel handle · no. 4L · 21 cm	1
04.13.13	RAGNELL (KILNER) Delicate dissecting scissors · curved · 13 cm	1
06.21.15	ADSON Tissue forceps · 1 × 2 teeth · 15 cm	1
06.25.15	ADSON-BROWN Tissue forceps · 9 × 9 teeth · 12 cm	1
06.48.20	POTTS-SMITH Tissue forceps · 1 × 2 teeth · 21 cm	1
06.48.25	ADSON Tissue forceps · 1 × 2 teeth · 25 cm	1
10.12.62	WRIGHT (DERF) HM Needle holder · fine · 12.5 cm	2
10.18.65	MAYO-HEGAR HM Needle holder · fine · 15 cm	2
10.18.73	MAYO-HEGAR HM Needle holder · fine · 23 cm	2
17.55.08	BACKHAUS Towel clamp · 8.5 cm	6
20.50.10	JOSEPH Delicate retractor · 2 teeth · 10 mm · sharp · 17 cm	2
22.10.12	FARABEUF-BABY Retractor · double-ended · 10/12 mm · 12 cm	1
22.72.06	ISRAEL Retractor · 60 × 50 mm · blunt · 6 teeth · 25 cm	1
24.90.50	SALDANHA-SOLZ Abdominal retractor · 37 cm	1
67.93.29	SOLZ Navel marker · dismantable · 29 cm	1
202.50.13	STEVENS Delicate scissors · supercut · curved · 11.5 cm	1
203.50.14	MAYO Dissecting scissors · supercut · straight · 14 cm	1
204.73.23	GORNEY Dissecting scissors · supercut · curved · 23 cm	1
204.75.23	GORNEY-FREEMAN Dissecting scissors · supercut · curved · 23 cm	1
• 204.79.20	SOLZ Dissecting scissors · supercut · curved · 20 cm	1
• 214.79.20	SOLZ Dissecting scissors · supercut · curved · 20 cm	1
49.60.22	Mediccontainer · 590 x 290 x 220 mm · silver	1
49.95.75	Wrapping drape · 160 x 80 cm · polyester · green	1
49.97.21	Wire basket · 510 x 255 x 50 mm	1
49.97.23	Wire basket · 510 x 255 x 100 mm	1



Instrumente, optional
 Instruments, optional
 Instrumentos, opcional
 Instruments, optionnel
 Strumenti, opzionale

**M10**

Präparation von Vollhauttransplantaten
Preparation of skin graft
Preparación de injertos de piel entera
Préparation des greffes de peau entière
Preparazione di innesti della cute intera

KASTEN

Item number	Description	Quantity
06.02.14	Dressing forceps · 14.5 cm	1
06.07.14	Tissue forceps · 1 × 2 teeth · 14.5 cm	1
10.18.70	MAYO-HEGAR HM Needle holder · normal · 20 cm	1
10.24.68	MICRO-SLIM HM Needle holder · fine · 18 cm	1
15.45.14	HALSTED-MOSQUITO Hemostatic forceps · curved · 14 cm	4
20.52.11	GUTHRIE Delicate retractor · 2 teeth · sharp · 13 cm	1
67.14.15	KASTEN Koriotom	1
67.14.20	Preparation plate · 200 × 130 × 11 mm	1
67.14.25	Spare blade · packing unit 10 pieces · 6.5 cm	1
202.41.62	Delicate dissecting scissors · supercut plus · curved · 12 cm	1
204.33.64	METZENBAUM Dissecting scissors · supercut plus · curved · 18 cm	1
49.50.10	Medicontainer · 290 × 290 × 100 mm · silver	1
49.95.73	Wrapping drape · 80 × 90 cm · polyester · green	1
49.97.02	Wire basket · 240 × 255 × 50 mm	1

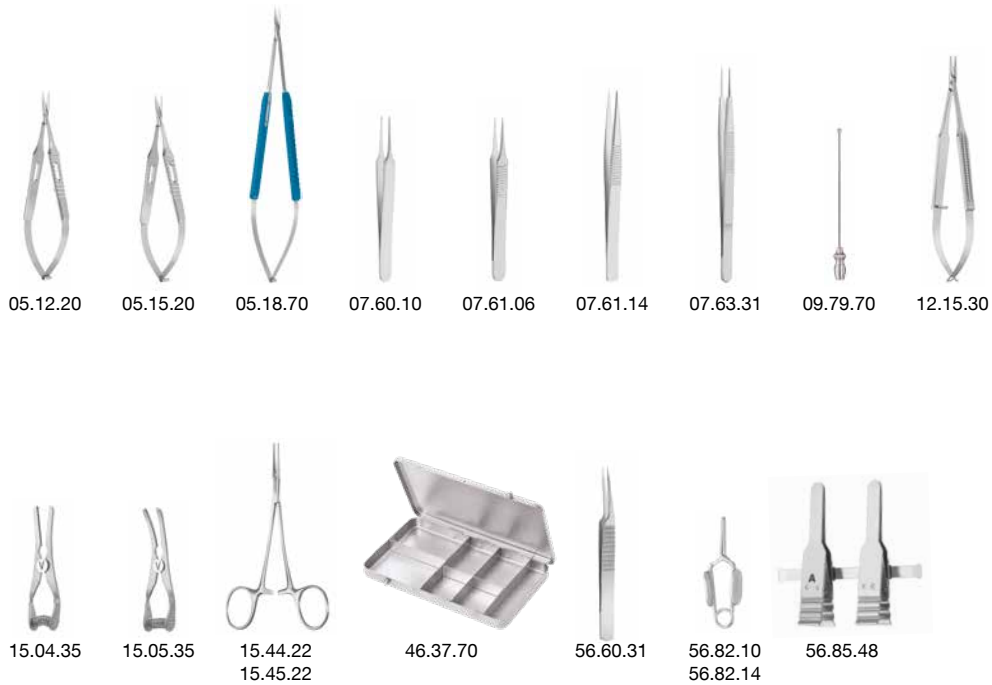

PART 1

Item number	Description	Quantity
05.12.20	MICRO 2000 STANDARD Micro scissors · straight · 12.5 cm	1
05.15.20	MICRO 2000 STANDARD Micro scissors · straight · 15 cm	1
05.18.70	MICRO 2000 STANDARD Micro scissors · straight · 18 cm	1
07.60.10	Micro forceps · straight · 1 × 2 teeth · 11.5 cm	1
07.61.06	MICRO 2000 Micro forceps · straight · blunt · 10.5 cm	1
07.61.14	MICRO 2000 Micro forceps · straight · blunt · 13.5 cm	1
07.63.31	MICRO 2000 Micro forceps · straight · sharp · 14 cm	1
• 07.63.32	MICRO 2000 Micro forceps · straight · blunt · 14 cm	1
09.79.70	Cannula with olive · Luer-Lock · 1.0 × 80 mm	2
12.15.30	MICRO 2000 Micro needle holder · straight · 15 cm	1
• 12.15.33	MICRO 2000 Micro needle holder · curved · 15 cm	1
15.04.35	Atraumatic titanium bulldog clamp · straight · 3.5 cm	2
• 15.04.40	Atraumatic titanium bulldog clamp · straight · 4 cm	2
15.05.35	Atraumatic titanium bulldog clamp · curved · 3.5 cm	2
15.44.22	ULTRA Hemostatic forceps · super delicate · straight · 12.5 cm	2
15.45.22	ULTRA Hemostatic forceps · super delicate · curved · 12.5 cm	2
46.37.70	Metal case · perforated · 150 × 95 × 13 mm	1
56.60.31	Vessel spreader · 11 cm	2
56.82.10	MÜLLER Vessel clip · closing pressure 50 g · straight	2
• 56.82.11	MÜLLER Vessel clip · closing pressure 50 g · curved	2
56.82.14	MÜLLER Vessel clip · closing pressure 50 g · laterally angled	2
56.85.48	Microvascular approximator · 8 mm	1
• 56.85.51	Microvascular approximator · 11 mm	1
• 56.85.54	Microvascular approximator · 14 mm	1





Mikrochirurgie
Micro Surgery
Microcirugía
Microchirurgie
Microchirurgia

M11



56.85.98

58.30.23

60.33.01

88.00.25



49.50.10

49.90.04

49.97.01

49.97.62

PART 2

Item number	Description	Quantity
56.85.98	Clip applying forceps · 11 cm	1
58.30.23	Micro vessel dilator · angled to side · 12.5 cm	1
• 58.30.24	Micro vessel dilator · angled to side · 12.5 cm	1
60.33.01	ANEL Tear duct cannula · Luer-Lock · straight · 4 cm	2
88.00.25	Bipolar cable · Ø 12.5 mm · 3 m	1
49.50.10	Medicontainer · 290 x 290 x 100 mm · silver	1
49.90.04	Instrument-tray with fixation device · 203 x 144 x 30 mm	1
49.97.01	Wire basket · 240 x 255 x 30 mm	1
49.97.62	Silicon mat · 6 mm · 240 x 220 mm	1



Alphabetischer und numerischer Index
Alphabetical and Numerical Index
Indice alfabético y numérico
Index alphabétique et numérique
Indice alfabetico e numerico

N



Z O B E L

**Alphabetischer Index**

Alphabetical Index

Índice alfabético

Index alphabétique

Índice alfabético

N01

A	
Anlegepinzetten für Mikro-Gefäßclips	77, 79
Approximatoren	79
Mikro-Gefäßclips	77, 79
Adapter	210, 226, 229
ADSON Anatomische Pinzette	45
ADSON-BROWN Chirurgische Pinzetten	47
ADSON Chirurgische Pinzetten	46
ADSON Feine Wundhaken	85
ADSON-GRAEFE Chirurgische Pinzette	47
ADSON HM Anatomische Pinzetten	45
ADSON HM Chirurgische Pinzetten	46
ADSON MICRO Anatomische Pinzetten	47
ADSON MICRO Chirurgische Pinzetten	47
ADSON TOENNIS Präparierscheren	27
AIACH Klemme	196
AIACH-GUBISCH Klemmen	196
ALAMUTI Gewebefasspinzette	149
Alarhäkchen	162
ALM Wundspreizer	100
Anatomische Pinzetten	45-46, 48-49
Anlegepinzetten	77-80
Anthelix-Knorpelfeilen	253-254
Antibeschlagmittel für Endoskope	274
Approximatoren	78-80
Arterienklemmen	73-76
ASCH Septumrichtzange	173
Atraumatische Brustdissektoren	202
AUFRIECHT GUBISCH Nasenhaken	165
AUFRIECHT Nasenhaken	164-165
AUFRIECHT Nasenraspeln	158
AUFRIECHT Rhinoplastikscheren	144
AUFRIECHT-DANIEL Nasenhaken	165
AUFRIECHT-WALTER Nasenhaken	166
Axilla-Saugkürette	232
B	
BABY FARABEUF Wundhaken	90
BABY LEXER Feine Präparierscheren	12
BABY-METZENBAUM Feine Präparierscheren	17, 18
BACKHAUS Tuchklemme	200
Bajonettpinzette	149
BALLENGER Septum-Hohlmeißel	184
BARBON LUBET Nasentamponzange	167
BARRAQUER Mikro Nadelhalter	68
BARSKY Feine Wundhaken	86
Bauchnabelpositionierer	237
Bauchretraktor	236
Beckenkamm-Reraktoren	97
BENICKE Feiner Wundhaken	87
BERGMANN Feine Wundhaken	86
BIEMER Anlegepinzetten	78

BIEMER Approximatoren	78, 80
BIEMER Mikro-Gefäßclips	78
BIG RING BABY-METZENBAUM Feine Präparierscheren	17
BIG RING Irisscheren	11
BIG RING METZENBAUM BABY Feine Präparierscheren	17
BIG RING STEVENS Feine Präparierscheren	17
BLAKE Skalpellgriff	2
BLAKESLEY Nasenzangen	169
BLAKESLEY WEIL Nasenzangen	169-170
BLAKESLEY WEIL Siebbeinzangen	170
Blattosteotome	113
Blepharopinzette	242
Blepharoplastikscheren	31
BLOCKSMA Gaumenspaltenhaken	118
BLUME Osteotom	192
BOIES Nasenfraktur-Elevatorium	175
BOZEMANN (WERTHEIM) HM Nadelhalter	65
BOZEMANN THOMSON-WALKER Nadelhalter	65
BRAND Sehnenführungszangen	258
BRAND Sehnenschäler	261
BROWN ADSON Chirurgische Pinzetten	47
BRÜNINGS LUC (HEYMANN) Nasenseptumzangen	168
BRÜSER-KELLY Feine Präparierscheren	18
Brustdissektoren	202-203
Brustheber	204
Brustreaktoren	205
BUCHWALD Zungenspatel	200
Bulldog-Klemmen	73
Bulldogschere	143
BUNNELL Sehnenführer	260
BUNNELL Sonde	256
C	
ÇAKIR Osteotom	189
ÇAKIR DANIEL Raspatorien	180
CAPLAN Nasenseptumschere	146
CASTROVIEJO HM Mikro Nadelhalter	68
CASTROVIEJO (KOSHIMA) Mikro Nadelhalter	68
CASTROVIEJO-EPKER Messzirkel	128
CASTROVIEJO Messzirkel	127, 199, 242
CASTROVIEJO-MICRO Nadelhalter	68
CAWOOD UNIV. MINNESOTA Wangenhalter	121
Chirurgische Pinzetten	45-49
Chirurgische Schere	43
CINELLI Osteotome	192
CINELLI Rhinoplastikschiere	143



CLAUDINHA Zungenspatel	122
CLAUS KILLIAN Septum-Hohlmeißel	184
CLINIC LAHEY Feiner Wundhaken	84
Clips Gefäß	77-80
COHEN Elevatorium	104
COLLIER Nadelhalter	59
Columella-Klemme	155
Container Sterilgut	268-269
CONVERSE-DANIEL Präparierschere	142
CONVERSE DERF Nadelhalter	62
CONVERSE HM Nadelhalter	60
CONVERSE Nadelhalter	59
CONVERSE Nasenfeile	161
CONVERSE Nasenflügelhaken	162
CONVERSE Raspatorium	107
CONVERSE Rhinoplastikmesser	174
CONVERSE Rhinoplastikscherer	143
COPE Feiner Wundhaken	81
COPE-WALTER Nasenhaken	81
COTTLE Alar- und Hauthäkchen	162
COTTLE Bulldogschere	143
COTTLE Columella-Klemme	155
COTTLE-DANIEL Raspatorium	180
COTTLE Elevatorium	175
COTTLE Feiner Wundhaken	87
COTTLE Flachmeißel	185
COTTLE Gewebefasspinzette	149
COTTLE-GUBISCH Flachmeißel	185
COTTLE Hammer	183
COTTLE HM Nasenraspel	157
COTTLE Knochenhebel und Spaltosteotom	191
COTTLE Knorpelquetsche	194
COTTLE-MASING Rhinoplastikscheren	143
COTTLE-MASING Schleimhaut-Nadelhalter	67
COTTLE-McKENTY Raspatorium	181
COTTLE MILLARD Nasenflügelhaken	163
COTTLE Nasenflügelhaken	162-164
COTTLE Nasenraspel	157
COTTLE Nasenseptumschere	148
COTTLE Nasenseptumspikulum	155
COTTLE Nasenspekula	154-155
COTTLE-NEIVERT Nasenflügelhaken	163
COTTLE Osteotome	186, 189
COTTLE Raspatorien	107, 181
COTTLE Rhinoplastikmesser	174
COTTLE Rhinoplastikscheren	143, 145, 147-148
COTTLE Septum-Elevatorien	177
COTTLE Tunnelier-Raspatorium	183
COTTLE WALTER Rhinoplastikscheren	146
COTTLE-WINTER Gewebefasspinzette	149
CRAIG-DOMNICK Vomerzangen	168

CRAIG Vomerzange	168
CRILE Feine Wundhaken	85, 152
CRILE-WOOD HM Nadelhalter	64
CRILE-WOOD Nadelhalter	64
D	
DANIEL AUFRICHT Nasenhaken	165
DANIEL-ÇAKIR Raspatorien	180
DANIEL CONVERSE Präparierschere	142
DANIEL COTTLE Raspatorium	180
DANIEL-GUBISCH Raspatorien	105-107
DANIEL JOSEPH Präparierscheren	29
DANIEL Pfriem	152
DANIEL Präparierschere	29
DAUTREY Drahtbügelschiene	137
DEAN Zahnfleissscheren	36
DEBAKEY AT Gewebefasspinzette	55
DEBAKEY HM Nadelhalter	64
DENHART Mundsperrer	122
DENHART-HOEFERT Mundsperrer	122
DERF-CONVERSE Nadelhalter	62
DERF WRIGHT HM Nadelhalter	61
DERF WRIGHT Nadelhalter	61
Dermatome	139-140
DESMARRES Lidhalter	93, 241
DIETHRICH Bulldog-Klemmen	73
Dilatationsstifte	265
DINGMAN Knorpelschaber	156
DINGMAN Mundsperrer	123
DINGMAN Raspatorium	109
Dissektoren	244-245
Dissektoren Brust	202-203
Dissektoren Haken	203
DOMNICK CRAIG Vomerzangen	168
DOROW Axilla-Saugkürette	232
DOROW V-Dissektor	232
Dosierhandgriffe	229
DOYEN Rippen-Raspatorien	251
Drahtbögen	137
Drahtbügelschiene	137
Drahtdrehklemme	136
Drähte	137
Drahtinstrumente	136
Drahtösenklemme	136
Drahtpositionierer	136
Drahtschere	251
Drahtspannzange	250
Durahäkchen	84
E	
Einweg-Kunststoffspritzen	210, 226, 230, 233
Elevatorien	104, 175-177, 245, 252



N01

Alphabetischer Index

Alphabetical Index

Índice alfabético

Index alphabétique

Índice alfabético

DEUTSCH

Elevatorien Saug	176
Elevatorien Septum	177
Elevatorium Nasenfraktur	175
Elevatorium Septumfraktur	176
EMMET Feiner Wundhaken	86
Endoskop-Führung	248, 263
Endoskope	248, 263
ENTNER Fadenführungsadeln	246
ENTNER Liposuction-Kanülen	212-214
EPKER CASTROVIEJO Messzirkel	128
ERICH Drahtbögen	137
Ersatzklingen für Dermatome	139-140
Ersatzklinge für Koriotom	138
EWALD HUDSON Anatomische Pinzette	45
EWALD HUDSON Chirurgische Pinzette	45
F	
Facelift-Markierer	127
Fadenführungsadeln	246
Fadenführungsschere	143
Fadenscheren	43-44
FANOUS-GUBISCH Osteotom	190
FANOUS Osteotome	190
FANOUS Präparierscheren	31
FANOUS Rhinoplastikscheren	145
FANOUS Unterminierscheren	31
FARABEUF Wundhaken	90
FARABEUF-BABY Wundhaken	90
Fasspinzetten	55-57, 149
Fasszangen	56, 247
Feder zur Markierung	126
Federhalter	126, 198
Feile Nase	161
Feine Pinzetten	45-48
Feine Präparierscheren	12-18
Feine Scheren	8-11
Feine Wundhaken	81-88, 151-152, 241
Feine Wundhaken doppelendig	81, 152
Finger-Goniometer	125
Fingerspreizer	256
FINSEN Wundspreizer	99
Fistelhaken	86
Fixierdraht mit Nadeln	252
Flachmeißel	185-187
FOMON GUBISCH HM Nasenraspel	161
FOMON Haken	241
FOMON Nasenflügelhaken	163
FOMON Nasenraspel	158
FOMON Osteotome	191
FOMON Rhinoplastikscheren	144-145
FOX Gewebefasspinzetten	57
FOX Gewebefasszange	56

FOX Zahnfleissscheren	36
FRAMER Sehnenführer	260
Fräser	196
FRAZIER Feiner Wundhaken	84
FREEMAN GORNEY Präparierscheren	33
FREEMAN METZENBAUM Präparierscheren	28
FREER Elevatorien	175
FREER Feiner Wundhaken	151
FREER Mukosamesser	178
FREER OBWEGESER Raspatorien	110
FREER Raspatorium	179
FREER Septum-Hohlmeißel	184
FUNKE Handfixierplatte	266

G

Gaumenspaltenhäkchen	118
Gaumenspalteninstrumente	118-120
Gaumenspaltenraspatorien	118, 120
Gefäßclips Mikro	77-80
Gewebefasspinzetten	55-57, 149
Gewebefasszange	56
GILLIES Chirurgische Pinzette	48
GILLIES Feine Wundhaken	85
GILLIES HM Nadelhalter	66
GILLIES Nadelhalter	66
GILLIES-SLIM HM Nadelhalter	66
GILLIES-SLIM Nadelhalter	66
GIUNTA Rhinoplastikscheren	146
Glaszylinderspritzen	226, 228
GOLDMAN Septumfraktur-Elevatorium	176
Goniometer	125
GORNEY Rhinoplastikscheren	148
GORNEY Präparierscheren	32
GORNEY-FREEMAN Präparierscheren	33
GRAEFE ADSON Chirurgische Pinzette	47
GREEN LANGENBECK Feine Wundhaken	83, 241
GREEN SENN Feine Wundhaken	82
GREENBERG PAR Feine Präparierscheren	14
GROSS Kornzange	200
GRUENWALD Bajonettpinzette	149
GUBISCH AIACH Klemmen	196
GUBISCH-AUFRICHT Nasenhaken	165
GUBISCH Blepharopinzette	242
GUBISCH COTTLE Flachmeißel	185
GUBISCH DANIEL Raspatorien	105-107
GUBISCH FANOUS Osteotom	190
GUBISCH Federhalter	126, 198
GUBISCH-FOMON HM Nasenraspel	161
GUBISCH HM Nadelhalter	150
GUBISCH-KILNER Nasenflügelhaken	162
GUBISCH Knorpelquetsche	194
GUBISCH Osteotome	188



GUBISCH Saugraspatorien	182
GUBISCH-RUBIN HM Septum-Quetschzange	197
GUILLEN Hammer	183
GUTHRIE Feine Wundhaken	152
H	
Häkchen Alar	162
Häkchen Haut	84, 86, 162
Häkchen Nerv	246
Häkchen Dura	84
Haken Fistel	86
Häkchen Gaumenspalten	118
Haken Muko-Periostal	119
Haken Nasen	81, 164-166
Haken Nasenflügel	162-164
Haken Ramus	94
Haken Spina-nasalis	96
Haken Tracheal	87
Haken Weichteil	95
Haken Weissheitszahn	96
Haken Wund	81-88
Hakendissektoren	203
Hakenscheren	247
HALLE TIECK Nasenspekula	153
HALSEY HM Nadelhalter	61
HALSEY Nadelhalter	61
HALSTED MICRO Arterienklemmen	74
HALSTED-MOSQUITO Arterienklemmen	76
Halter Kinn	98
Halter Lid	93
Halter Lippen	121
Halter Wangen	121
Hämmer	183
Handfixierplatte	266
Handgriff	264
Handgriffe für Kanülen	222, 233
HANNA Zungenspatel	122
HARALDSSON Sauglevatorium	176
HARGIS Raspatorium	108
HARTMANN Nasenspekula	153
HARTMANN Nasentamponzangen	167
Haut-Spannplatte	140
Hauthäkchen	84, 86, 162
HEERMANN Handgriff	264
HEGAR MAYO HM Nadelhalter	63
HEGAR MAYO Nadelhalter	62
HEYMANN Nasenseptumzangen	168
HEYMANN Rhinoplastikscheren	142
HINDERER Knorpelfasspinzette	149
HM Nadelhalter	60-61, 63-69, 150
HM Pinzetten	26-27
HOEFERT DENHART Mundsperrer	122

Hohlmeißel	184
Hohlmeißel Septum	184
Hohlmeißelzangen	257
HOSPITAL PROVIDENCE Arterienklemmen	75
HOUGH Rhinoplastikschere	147
HUDSON-EWALD Anatomische Pinzette	45
HUDSON-EWALD Chirurgische Pinzette	45
HUMBY Dermatome	139
HUMBY Feiner Wundhaken	85
I	
Infiltrationspumpe für die Liposuction	234
Infiltrationskanülen	210
Injektionskanülen	210, 230
Instrumentenablage, magnetisch	273
Instrumentenpflegeöle	274
Interdentale Osteotome	111
IRIS Feine Scheren	9-11
IRIS MICRO Feine Scheren	11
Irisscheren	9-11
J	
JABALEY Feine Scheren	8
JACKSON Feiner Wundhaken	81
JACKSON Trachealhaken	87
JACOBSON HM Mikro Nadelhalter	69
JACOBSON MICRO 2000 Mikro Scheren	39
JACOBSON MICRO Arterienklemmen	74
JACOBSON Mikro Nadelhalter	69
JAMESON Feine Präparierscheren	17
JAMESON REYNOLDS Präparierscheren	30
JAMESON Schieblehre	125
JANSEN Löffel	107
JOSEPH-DANIEL Präparierscheren	29
JOSEPH Feine Präparierscheren	15
JOSEPH Feine Wundhaken	151, 152
JOSEPH Nasensägen	171
JOSEPH PECK Feine Präparierscheren	15
JOSEPH Rhinoplastikmesser	174
JOSEPH Rhinoplastikschere	147
JOSEPH Septum-Knorpelmesser	174
JOSEPH Stablehre	199
JOSEPH-MASING Septum-Raspatorium	107
K	
KAHRE Gaumenspalten-Raspatorium	118
Kanülen Injektion	210, 230
Kanülen Liposuction	212-221
Kanülen zur Eigenfettentnahme	224-225
Kanülen zur Eigenfettunterspritzung	223
Kanülen zur Infiltration	210
Kanülen-Ansätze	208



N01

Alphabetischer Index

Alphabetical Index

Índice alfabético

Index alphabétique

Índice alfabético

DEUTSCH

KASTEN Koriotom	138
KAYE Präparierscheren	31, 35
Keilosteotome	112
KELLY BRÜSER Feine Präparierscheren	18
KELLY Fadenschere	44
KELLY Präparierscheren	29
KILLIAN-CLAUS Septum-Hohlmeißel	184
KILLIAN Nasenspekula	154
KILLIAN Septum-Hohlmeißel	184
KILNER GUBISCH Nasenflügelhaken	162
KILNER Nasenflügelhaken	162
KILNER RAGNELL Feine Präparierscheren	14
Kinnhalter	98
KISTLER Anthelix-Knorpelfeilen	253-254
Klapp-Okkludator	128
KLEINERT-KUTZ Feine Wundhaken	86
KLEINERT-KUTZ Sehnenführungszangen	258
Klemme Columella	155
Klemme Knorpel	196
Klemme Tuch	200
Klemmen Arterien	73-76
Klemmen Bulldog	73
Klemmen Sehneneinflecht	259
KNAPP Feine Präparierscheren	12-13
Knochendrähte	137
Knochenformzangen	116
Knochenhaltezange	257
Knochenhebel	191
Knocheninstrumente	116-117, 196-197
Knochenmesszirkel	127
Knochenmühle	117
Knochenpfrieme	152, 256
Knorpel-Quetschzange	196
Knorpelfasspinzetten	57, 149
Knorpelfeilen	253-254
Knorpelinstrumente	116-117, 194-197
Knorpelklemme	196
Knorpelmesser Septum	174
Knorpelquetschen	194
Knorpelschaber	156
Knorpelschere	144
Knorpelschneidblöcke	195
KOCHER Wundhaken	91
Koriotom	138
Kornzangen	200
KOSHIMA CASTROVIEJO Mikro Nadelhalter	68
KOSHIMA MICRO JACOBSON Arterienklemmen	75
KOSHIMA Mikro Schere	37
KOTZUR Liposuction-Kanüle	217
KRETSCHMER Referenz-Pin	129

Kürette Saug	232
Kunststoffspritzen	210, 226, 230, 233
KUTZ KLEINERT Feine Wundhaken	86
KUTZ KLEINERT Sehnenführungszangen	258

L

LAHEY-CLINIC Feiner Wundhaken	84
LANDOLT Skalpellgriffe	4
LANGENBECK Elevatorium	175
LANGENBECK-GREEN Feine Wundhaken	83, 241
LANGENBECK PARKER (US ARMY) Wundhaken	89
LANGENBECK Rhinoplastikmesser	174
LANGENBECK Wundhaken	91
LEMPERT Raspatorien	105
LERICHE Arterienklemmen	76
LEWIS HM Nasenraspel	158
LEWIS Nasenraspel	157
LEXER-BABY Feine Präparierscheren	12
LEXER MAYO Präparierscheren	20
LEXER Präparierscheren	20
Lidfasspinzette	56
Lidhalter	93
Ligaturscheren	42
LINDEMANN Fräser	196
Lipo-Injektion-Dosierhandgriffe	229
Liposuction-Kanülen	212-221
Lippenhalter	121
Lippeninstrumente	118-120
LITTAUER Fadenschere	44
LITTLER Fadenführungsschere	143
Löffel	107
LUBET-BARBON Nasentamponzange	167
LUC-BRÜNINGS (HEYMANN) Nasenseptumzangen	168

M

MAGGY Instrumentenablage, magnetisch	273
MALTZ Nasenraspel	156
Mamillenringe	204
Markierungsinstrumente	125-129, 199
MARX Brustretractoren	205
MASING COTTLE Rhinoplastikscheren	143
MASING COTTLE Schleimhaut-Nadelhalter	67
MASING JOSEPH Septum-Raspatorium	107
MASING Nasenfeile	161
MASING Nasenflügelhaken	163
MASING Nasenraspel	161
MASING Septum-Elevatorium	177
MATHIEU HM Nadelhalter	67
Maxilla-Mobilisator	115
MAYO-HEGAR HM Nadelhalter	63



MAYO-HEGAR Nadelhalter	62
MAYO-LEXER Präparierscheren	20
MAYO Präparierscheren	19
MAYO-STILLE Präparierscheren	21
McINDOE Anatomische Pinzette	48
McINDOE Flachmeißel	187
McINDOE Gaumenspalten-Raspatorium	118
McINDOE Knorpelschere	144
McKENTY COTTLE Raspatorium	181
McKENTY Raspatorien	179
McKESSON Mundkeile	124
Medicontainer	268-269
Meißel	184-187
MERCEDES Liposuction-Kanülen	217
MERSHON Drahtpositionierer	136
Messer	264
Messer Modellier	250
Messer Mukosa	178
Messer Rhinoplastik	174
Messer Septum	174
Messereinsätze	264
Messinstrumente	125-129, 199
Messzirkel	127-128, 199, 242
METZENBAUM BABY Feine Präparierscheren	17, 18
METZENBAUM-FREEMAN Präparierscheren	28
METZENBAUM MINI Feine Präparierscheren	18
METZENBAUM NELSON Präparierscheren	24-25
METZENBAUM Präparierscheren	22-23, 28
METZENBAUM-SLIM Präparierscheren	26-27
MEYERDING Feine Wundhaken	82
MICRO 2000 JACOBSON Mikro Scheren	39
MICRO 2000 (KOSHIMA) Mikro Pinzette	51
MICRO 2000 Mikro Nadelhalter	69-70
MICRO 2000 Mikro Pinzetten	50-52
MICRO 2000 Mikro Scheren	37-40
MICRO 2000 Nahtpinzetten	54
MICRO-ADSON Anatomische Pinzetten	47
MICRO-ADSON Chirurgische Pinzetten	47
MICRO CASTROVIEJO Nadelhalter	68
MICRO-HALSTED Arterienklemmen	74
MICRO-IRIS Feine Scheren	11
MICRO-JACOBSON Arterienklemmen	74
MICRO-JACOBSON (KOSHIMA) Arterienklemmen	75
Mikro-Gefäßclips	77-80
Mikro Pinzetten	50-53
Mikro Scheren	37-41

Mikro-Nadelhalter	68-72
Mikro-Sägen	130-135
Mikro-Sagittal-Säge	131
Mikro-Stichsäge	133
MILLARD (COTTLE) Nasenflügelhaken	163
MILLER SENN Feine Wundhaken	81
MINI-METZENBAUM Feine Präparierscheren	18
MOBERG Flachmeißel	187
Mobilisator Maxilla	115
MOD. LANZ Feiner Wundhaken	83
MOD. LANZ Knochenhaltezeange	257
MOD. LANZ Knochenpfriem	256
MOD. LANZ Sehnenschäler	261
MOD. WIEN Nasenspekula	153
Modelliermesser	250
MOLT Mundsperrer	122
MÖLTGEN Winkelmesser	125
MOSQUITO AT Arterienklemmen	74
MOSQUITO HALSTED Arterienklemmen	76
Muko-Periostal-Haken	119
Mukosamesser	178
Mundkeile	124
Mundsperrer	122-123

N

Nadelhalter	58-72, 150
Nadelhalter HM	60-61, 63-69, 150
Nadelhalter HM Erläuterung	58
Nadelhalter Mikro	68-72
Nadelhalter mit Schere	66
Nadelhalter Schleimhaut	67
Nadelhalter Titan	72
Nadeln Fadenführung	246
NAGATA Elevatorien	104, 252
NAGATA HM Nadelhalter	60
NAGATA Modelliermesser	250
Nahtpinzetten	54
Nasenfeilen	161
Nasenflügelhaken	162-164
Nasenfraktur-Elevatorium	175
Nasenhaken	81, 164-166
Nasenraspeln	156-161
Nasentrückenscheren	148
Nasensägen	171
Nasenseptum-Osteotome	193
Nasenseptumscheren	146, 148
Nasenseptumspekulum	155
Nasenseptumzangen	168, 172-173
Nasenspekula	153-155
Nasenspitzenmarkierer	199
Nasentamponzangen	167
Nasenzangen	169-170

**Alphabetischer Index**

Alphabetical Index

Índice alfabético

Index alphabétique

Índice alfabético

N01**DEUTSCH**

NEIVERT COTTLE Nasenflügelhaken	163
NEIVERT HM Nadelhalter	60
NEIVERT Nadelhalter	59
NEIVERT Nasenflügelhaken	163
NELSON Gewebefasspinzetten	55
NELSON-METZENBAUM Präparierscheren	24-25
Nerv-Approximator	80
Nervhäkchen	246
NEWS Trachealhaken	87
NIRO HM Drahtspannzange	250

O

O'BRIEN Fadenschere	44
OBWEGESER Beckenkamm-Retraktoren	97
OBWEGESER Blattosteotome	113
OBWEGESER Drahtösenklemme	136
OBWEGESER-FREER Raspatorien	110
OBWEGESER HM Drahtdrehklemme	136
OBWEGESER Interdentale Osteotome	111
OBWEGESER Keilosteotome	112
OBWEGESER Kinnhalter	98
OBWEGESER Klapp-Okkludator	128
OBWEGESER Knochenformzangen	116
OBWEGESER Maxilla-Mobilisator	115
OBWEGESER Nasenraspeln	159
OBWEGESER Nasenrückenscheren	148
OBWEGESER Nasenseptum-Osteotome	193
OBWEGESER Osteotome	111-113
OBWEGESER Progenie-Rinnen	98
OBWEGESER Ramushaken	94
OBWEGESER Raspatorien	108-109
OBWEGESER Rippen-Raspatorien	106
OBWEGESER Nasenseptumzangen	173
OBWEGESER Spaltosteotome	112
OBWEGESER Spina-nasalis-Haken	96
OBWEGESER Tuber Osteotom	111
OBWEGESER Unterkieferrand-Retraktor	93
OBWEGESER Weichteilhaken	95
OBWEGESER Weisheitszahnhaken	96
Okkludator	128
Optiken	248, 263
Orbitaboden-Raspatorium	110
Orbital-Osteotome	115
Osseoskalpell	132
Osteotome	111-115, 186-193
Osteotome Blatt	113
Osteotome Interdental	111
Osteotome Keil	112
Osteotome Nasenseptum	193
Osteotome Orbital	115
Osteotome Spalt	112, 191

Osteotome Zylinder	114
Osteotom Tuber	111
Oszillierende Mikro-Säge	130

P

PARKER-LANGENBECK (US ARMY) Wundhaken	89
PEAN Arterienklemme	74
PECK-JOSEPH Feine Präparierscheren	15
PENNINGTON Elevatorium	104
Pfriem	152, 256
Phalangenhaltezange	257
Pinzette Bajonett	149
Pinzette Blepharo	242
Pinzette Lidfass	56
Pinzetten anatomisch	45-46, 48-49
Pinzetten Anlege	77-80
Pinzetten chirurgisch	45-49
Pinzetten Fass	55-57
Pinzetten fein	45-48
Pinzetten Gewebefass	55-57, 149
Pinzetten HM	31, 35
Pinzetten Knorpelfass	57, 149
Pinzetten Mikro	50-53
Pinzetten Naht	54
Pinzetten Titan	53
PITANGUY Facelift-Markierer	127
Präparationsplatte	138
Präparierscheren	19-35
Präparierscheren fein	12-18
Progenie Rinnen	98
PROVIDENCE-HOSPITAL Arterienklemmen	75

Q

Quetschzange Knorpel	196
Quetschzangen	196-197
Quetschzangen Septum	197

R

RAGNELL Feine Wundhaken	81
RAGNELL (KILNER) Feine Präparierscheren	14
Ramushaken	94
Raspatorien	105-110, 179-182, 244
Raspatorien Gaumenspalten	118, 120
Raspatorien Rippen	106, 251
Raspatorien Saug	182
Raspatorium Orbitaboden	110
Raspatorium Septum	107
Raspatorium Tunnelier	181
Raspelaufsatz	133
Raspeln Nasen	156-161



Referenz-Pin	129
Retraktor Bauch	236
Retraktor mit Endoskopkanal	248
Retraktor Unterkieferrand	93
Retraktoren Beckenkamm	97
Retraktoren Brust	205
REYNOLDS (JAMESON) Präparierscheren	30
Rhinoplastikmesser	174
Rhinoplastikscheren	142-148
Rippen-Raspatorien	106, 251
RUBIN GUBISCH HM Septum-Quetschzange	197
RUBIN HM Septum-Quetschzange	197
RUBIN Osteotome	186, 191
RUBIN Septum-Quetschzangen	197
Rundschale	204
RUSS. MOD. Gewebefasspinzette	55

S

SACHSE Mikro-Sagittal-Säge	131
SACHSE Osseoskalpell	132
SACHSE Oszillierende Mikro-Säge	130
Sägeblätter	130-133
Sägen Mikro	130-135
Sägen Nasen	171
SALDANHA-SOLZ Bauchretraktor	236
Saugelevatorien	176
Saugkürette Axilla	232
Saugraspatorien	182
Schale für Markierungsfarbe	204
Schere Bulldog	143
Schere chirurgisch	43
Schere Draht	251
Schere Fadenführung	143
Schere Knorpel	144
Scheren	5-44
Scheren Blepharoplastik	31
Scheren Erläuterung	6
Scheren Faden	43-44
Scheren fein	8-18
Scheren Haken	247
Scheren Iris	9-11
Scheren Ligatur	42
Scheren Mikro	37-41
Scheren Nasenrücken	148
Scheren Nasenseptum	146, 148
Scheren Präparier	12-35
Scheren Rhinoplastik	142-148
Scheren Unterminier	15, 31
Scheren Zahnfleisch	36
Schieblehren	125
SCHINK Dermatome	140
Schleimhaut-Nadelhalter	67

Schneidblock	195
SCHROM Osteotome	190
Sehneneinflechtklemmen	259
Sehnenführer	260
Sehnenführungszangen	258
Sehnenhaltezange	257
Sehnenschäler	261
SEMKEN Anatomische Pinzetten	48
SEMKEN Chirurgische Pinzetten	48
SENN-GREEN Feine Wundhaken	82
SENN-MILLER Feine Wundhaken	81
SENNING HM Nadelhalter	65
SENNING Nadelhalter	65
Septum-Elevatorien	177
Septum-Hohlmeißel	184
Septum-Knorpelmesser	174
Septum-Quetschzangen	197
Septum-Raspatorium	107
Septumfraktur-Elevatorium	176
Septumrichtzangen	172-173
Septumzangen	172-173
SHEA Feine Präparierscheren	14
SHEPARD Zylinder-Osteotome	114
Siebbeinzangen	170
SIEGERT Unterminierscheren	15
SILVER Dermatome	140
SILVER Osteotome	192
Skalpelle	2-4
Skalpellgriffe	2-4
Skalpellsklingen	2-4
SLIM Feine Präparierscheren	16
SLIM GILLIES HM Nadelhalter	66
SLIM GILLIES Nadelhalter	66
SLIM METZENBAUM Präparierscheren	26-27
SOLZ Atraumatische Brustdissektoren	202
SOLZ Bauchnabelpositionierer	237
SOLZ Hakendisektoren	203
SOLZ Mamillenringe	204
SOLZ Präparierscheren	34
SOLZ SALDANHA Bauchretraktor	236
Sonde	256
Spaltosteotome	112, 191
Spannzange	250
Spannplatte Haut	140
Spatel Zunge	122, 200
Spekula Nasen	153-155
Spekulum Nasenseptum	155
SPENCER Fadenscheren	43
Sperrer Mund	122-123
Spina-nasalis-Haken	96
Spreizer Finger	256
Spreizer Wund	99-101

**Alphabetischer Index**

Alphabetical Index

Índice alfabético

Index alphabétique

Índice alfabético

N01**DEUTSCH**

Spritzen	210, 226, 228, 230, 233
Spritzen zur Infiltration	210
Spritzenständer	228
Spritzenstopp	226
Sprühöl	274
Stablehre	199
Stahllineale	125
STEINHÄUSER Orbitaboden-Raspatorium	110
STEINHÄUSER Orbital-Osteotome	115
STEINMANN Sehnenhaltezeuge	257
STELLBRINK Hohlmeißelzangen	257
Sterilgut-Container	268-269
STERNBERG Wangenhalter	121
STEVENS Feine Präparierscheren	13, 17
STEVENS Feine Scheren	8, 11
STILLE MAYO Präparierscheren	21
STILLE STRANDELL Feine Wundhaken	83, 241
STRAIGHT Feiner Wundhaken	84
STRANDELL-STILLE Feine Wundhaken	83, 241
SULSENTI WINTER HM Nadelhalter	150
T	
TEBBETTS Wundhaken	92
TESSIER Osteotome	113
TESSIER Raspatorien	110
THOMSON-WALKER (BOZEMANN) Nadelhalter	65
THORPE Schieblehre	125
TIECK-HALLE Nasenspekula	153
Titan Mikro Nadelhalter	72
Titan Nadelhalter	72
Titan Pinzetten	53
TOENNIS-ADSON Präparierscheren	27
TOLEDO Kanüle zur Eigenfettentnahme	224
TOLEDO Liposuction-Kanülen	216
Trachealhaken	87
Transfer-Adapter	229
Trays für Endoskope	272
Trays für feine Instrumente	270-271
TROELTSCH (WILDE) Gewebefasspinzette	56
Trokare	114
TSCHOEPE Knorpel-Quetschzange	196
Tuber Osteotom	111
Tuchklemme	200
Tunnelier-Raspatorium	181
U	
UNIV. MINNESOTA CAWOOD Wangenhalter	121
UNIVERSAL HM Drahtschere	251
UNIVERSAL WALSHAM Septumrichtzange	172

Unterkieferrand-Retraktor	93
Unterminierscheren	15, 31
US ARMY Wundhaken	89
V	
V-Dissektor	232
Vakuum-Glaszylinderspritzen	226, 228
Vomerzangen	168
VON GREGORY Infiltrationskanüle	210
VON GREGORY Kanülen zur Eigenfettentnahme	224-225
W	
WALKER THOMSON (BOZEMANN) Nadelhalter	65
WALSHAM Septumrichtzangen	172
WALSHAM UNIVERSAL Septumrichtzange	172
WALTER AUFRICHT Nasenhaken	166
WALTER COPE Nasenhaken	81
WALTER Flachmeißel	186
WALTER Lidfasspinzette	56
WALTER Osteotome	187
WALTER Rhinoplastikschere	145
WALTER Wundhaken	89
WALTER Wundhaken mit Kaltlichtbeleuchtung	166
WALTER-COTTLE Rhinoplastikscheren	146
WANG Mundsperrer	123
WANG Raspatorien	120
Wangenhalter	121
WATSON Dermatome	139
WAUGH Anatomische Pinzetten	49
WAUGH Chirurgische Pinzetten	49
Weichteilhaken	95
WEIL-BLAKESLEY Nasenzangen	169-170
WEIL-BLAKESLEY Siebbeinzangen	170
Weisheitszahnzangen	96
WEITLANER Wundspreizer	100-101
WERTHEIM BOZEMANN HM Nadelhalter	65
WESTMACOTT Nasentamponzangen	167
WIENER MOD. Nasenspekula	153
WILDE TROELTSCH Gewebefasspinzette	56
WILLIGER Löffel	107
WILLIGER Raspatorien	179
Winkelmesser	125
WINTER COTTLE Gewebefasspinzette	149
WINTER Rhinoplastikschere	147
WOOD CRILE HM Nadelhalter	64
WOOD CRILE Nadelhalter	64
WRIGHT (DERF) HM Nadelhalter	61
WRIGHT (DERF) Nadelhalter	61
Wundhaken	81-98



N01

Wundhaken fein	81-88, 151-152, 241
Wundhaken mit Kaltlichtbeleuchtung	92, 166
Wundspreizer	99-101
Y	
YANKAUER Septum-Elevatorium	177
Z	
Zahnfleischscheren	36
Zange Drahtspann	250
Zangen Fass	56, 247
Zange Gewebefass	56
Zange Knochenhalte	257
Zange Phalangenhalte	257
Zange Sehnenhalte	257
Zangen Hohlmeißel	257
Zangen Knochenform	116
Zangen Korn	200
Zangen Nasen	169-170
Zangen Nasenseptum	168, 172-173
Zangen Nasentampon	167
Zangen Quetsch	196-197
Zangen Sehnenführung	258
Zangen Septum	172-173
Zangen Septumricht	172-173
Zangen Siebbein	170
Zangen Vomer	168
Zungendrucker	123
Zungenspatel	122, 200
Zylinder-Osteotome	114



Alphabetischer Index
Alphabetical Index
Índice alfabético
Index alphabétique
Índice alfabético

N02

ENGLISH

A	
Abdominal retractor	236
Applying forceps for micro vessel clips	77, 79
Approximators	79
Micro vessel clips	77, 79
Adaptor	210, 226, 229
ADSON-BROWN Tissue forceps	47
ADSON Delicate retractors	85
ADSON Dressing forceps	45
ADSON-GRAEFE Tissue forceps	47
ADSON HM Dressing forceps	45
ADSON HM Tissue forceps	46
ADSON MICRO Dressing forceps	47
ADSON MICRO Tissue forceps	47
ADSON Tissue forceps	46
ADSON TOENNIS Dissecting scissors	27
AIACH Forceps	196
AIACH-GUBISCH Forceps	196
ALAMUTI Tissue grasping forceps	149
Alar hooks	162
Alar retractors	162-164
ALM Self-retaining retractors	100
Aluminium containers	268-269
Anthelix cartilage files	253-254
Antifog solution for endoscopes	274
Applying forceps	77-80
Approximators	78-80
Arch bars	137
Areola marker	204
Articulator	128
ASCH Septum straightening forceps	173
Atraumatic breast dissectors	202
AUFRICHT-DANIEL Nasal retractor	165
AUFRICHT GUBISCH Nasal retractors	165
AUFRICHT Nasal rasps	158
AUFRICHT Nasal retractors	164-165
AUFRICHT Rhinoplasty scissors	144
AUFRICHT-WALTER Nasal retractors	166
Awl	152, 256
Axilla suction curette	232
B	
BABY FARABEUFR Retractor	90
BABY LEXER Delicate dissecting scissors	12
BABY-METZENBAUM Delicate dissecting scissors	17, 18
BACKHAUS Towel clamp	200
BALLENGER Septum gouges	184
BARBON LUBET Nasal dressing forceps	167
BARRAQUER Micro needle holders	68
BARSKY Delicate retractors	86
Bayonet forceps	149

BENICKE Delicate retractors	87
BERGMANN Delicate retractor	86
BIEMER Applying forceps	78
BIEMER Approximators	78, 80
BIEMER Micro vessel clips	78
BIG RING BABY-METZENBAUM Delicate dissecting scissors	17
BIG RING Iris scissors	11
BIG RING METZENBAUM BABY Delicate dissecting scissors	17
BIG RING STEVENS Delicate dissecting scissors	17
Blade osteotomes	113
BLAKE Scalpel handle	2
BLAKESLEY Nasal forceps	169
BLAKESLEY WEIL Nasal forceps	169-170
BLAKESLEY WEIL Ethmoid bone forceps	170
Blepharoplasty forceps	242
Blepharoplasty scissors	31
BLOCKSMA Cleft palate hooks	118
BLUME Osteotome	192
BOIES Nasal fracture elevator	175
Bone bending pliers	116
Bone bow spacer	127
Bone holding forceps	257
Bone instruments	116-117, 196-197
Bone lever	191
Bone mill	117
Bone piercers	152, 256
Bone rongeurs	257
Bone wires	137
Bow spacer	127
Bowl for marking colour	204
BOZEMANN (WERTHEIM) HM Needle holders	65
BOZEMANN THOMSON-WALKER Needle holder	65
BRAND Tendon stripper	261
BRAND Tendon tunneling forceps	258
Breast dissectors	202-203
Breast elevator	204
Breast retractors	205
BROWN ADSON Tissue forceps	47
BRÜNINGS LUC (HEYMANN) Nasal septum forceps	168
BRÜSER-KELLY Delicate dissecting scissors	18
BUCHWALD Tongue spatula	200
Bulldog clamps	73
Bulldog scissors	143
BUNNELL Probe	256



BUNNELL Tendon passers	260
Burrs	196
C	
ÇAKIR Osteotome	189
ÇAKIR DANIEL Raspatories	180
Calipers	125, 127-128, 199, 242
Cannula connectors	208
Cannulas for autologous fat transfer	224-225
Cannulas for lipoinjection	223
Cannulas for infiltration	210
Cannulas injection	210, 230
Cannulas liposuction	212-221
CAPLAN Nasal septum scissors	146
Cartilage abraders	156
Cartilage crushers	194
Cartilage cutting blocks	195
Cartilage files	253-254
Cartilage grasping forceps	57, 149
Cartilage instruments	116-117, 194-197
Cartilage knife septum	174
Cartilage morselizer forceps	196
Cartilage scissors	144
CASTROVIEJO Calipers	127, 199, 242
CASTROVIEJO-EPKER Calipers	128
CASTROVIEJO HM MICRO Needle holders	68
CASTROVIEJO (KOSHIMA) Micro needle holders	68
CASTROVIEJO-MICRO Needle holders	68
CAWOOD UNIV. MINNESOTA Cheek retractor	121
Channel retractors	98
Cheek retractors	121
Chin retractor	98
Chisels	185-187
CINELLI Osteotomes	192
CINELLI Rhinoplasty scissors	143
Clamps Bulldog	73
Clamp towel	200
CLAUDINHA Tongue spatula	122
CLAUS KILLIAN Septum gouge	184
Cleft palate hooks	118
Cleft palate instruments	118-120
Cleft palate raspatories	118, 120
CLINIC LAHEY Delicate retractor	84
Clips vessel	77-80
COHEN Elevator	104
COLLIER Needle holder	59
Columella forceps	155

Containers for sterilization	268-269
CONVERSE Alar retractor	162
CONVERSE-DANIEL Dissecting scissors	142
CONVERSE DERF Needle holder	62
CONVERSE HM Needle holder	60
CONVERSE Nasal file	161
CONVERSE Needle holder	59
CONVERSE Raspatory	107
CONVERSE Rhinoplasty knife	174
CONVERSE Rhinoplasty scissors	143
COPE Delicate retractor	81
COPE-WALTER Nasal retractor	81
Coriotome	138
COTTLE Alar and skin hooks	162
COTTLE Alar retractors	162-164
COTTLE Bone lever and splitting osteotome	191
COTTLE Bulldog scissors	143
COTTLE Cartilage crusher	194
COTTLE Chisels	185
COTTLE Columella forceps	155
COTTLE-DANIEL Raspatory	180
COTTLE Delicate retractor	87
COTTLE Elevator	175
COTTLE-GUBISCH Chisels	185
COTTLE HM Nasal rasp	157
COTTLE Mallet	183
COTTLE-MASING Mucosa needle holders	67
COTTLE-MASING Rhinoplasty scissors	143
COTTLE-McKENTY Raspatory	181
COTTLE MILLARD Alar retractor	163
COTTLE Nasal rasp	157
COTTLE Nasal septum scissors	148
COTTLE Nasal septum speculum	155
COTTLE Nasal specula	154-155
COTTLE-NEIVERT Alar retractor	163
COTTLE Osteotomes	186, 189
COTTLE Raspatories	107, 181
COTTLE Rhinoplasty knives	174
COTTLE Rhinoplasty scissors	143, 145, 147-148
COTTLE Septum elevators	177
COTTLE Tissue grasping forceps	149
COTTLE Tunnelling elevator	183
COTTLE WALTER Rhinoplasty scissors	146
COTTLE-WINTER Tissue grasping forceps	149
CRAIG-DOMNICK Vomer forceps	168
CRAIG Vomer forceps	168
CRILE Delicate retractors	85, 152
CRILE-WOOD HM Needle holders	64
CRILE-WOOD Needle holders	64
Curettes	107
Curette suction	232



Alphabetischer Index
Alphabetical Index
Índice alfabético
Index alphabétique
Índice alfabético

N02

ENGLISH

Cutting block	195
Cutting burrs	196
Cylinder osteotomes	114

D

DANIEL AUFRICHT Nasal retractor	165
DANIEL Awl	152
DANIEL-ÇAKIR Raspatories	180
DANIEL CONVERSE Dissecting scissors	142
DANIEL COTTLE Raspatory	180
DANIEL Dissecting scissors	29
DANIEL-GUBISCH Raspatories	105-107
DANIEL JOSEPH Dissecting scissors	29
DAUTREY Arch bar	137
DEAN Gum scissors	36
DEBAKEY AT Tissue grasping forceps	55
DEBAKEY HM Needle holders	64
Delicate dissecting scissors	12-18
Delicate forceps	45-48
Delicate retractors	151-152, 81-88, 241
Delicate retractors double-ended	81, 152
Delicate scissors	8-11
DENHART-HOEFERT Mouth gag	122
DENHART Mouth gag	122
DERF WRIGHT HM Needle holder	61
DERF WRIGHT Needle holder	61
DERF-CONVERSE Needle holder	62
Dermatomes	139-140
DESMARRES Lid retractors	93, 241
DIETHRICH Bulldog clamps	73
Dilation rods	265
DINGMAN Cartilage abraders	156
DINGMAN Mouth gag	123
DINGMAN Raspatory	109
Disposable plastic syringes	210, 226, 230, 233
Dissecting scissors	19-35
Dissecting scissors delicate	12-18
Dissectors	244-245
Dissectors breast	202-203
Dissectors hook	203
DOMNICK CRAIG Vomer forceps	168
DOROW Axilla suction curette	232
DOROW V dissector	232
DOYEN Rib raspatories	251
Dressing forceps	45-46, 48-49, 200
Dura hooks	84

E

Elevator for fracture of septum	176
Elevator nasal fracture	175
Elevators	104, 175-177, 245, 252
Elevators septum	177

Elevators suction	176
EMMET Delicate retractor	86
Endoscope guides	248, 263
Endoscopes	248, 263
ENTNER Ligature needles	246
ENTNER Liposuction cannulas	212-214
EPKER CASTROVIEJO Calipers	128
ERICH Arch bars	137
Ethmoid bone forceps	170
EWALD HUDSON Dressing forceps	45
EWALD HUDSON Tissue forceps	45

F

Facelift marker	127
FANOUS Dissecting scissors	31
FANOUS Osteotomes	190
FANOUS Rhinoplasty scissors	145
FANOUS Undermining scissors	31
FANOUS-GUBISCH Osteotome	190
FARABEUF-BABY Retractor	90
FARABEUF Retractor	90
Finger goniometer	125
Finger spreader	256
FINSEN Self-retaining retractors	99
Fistula hook	86
Fixation wire with needles	252
Flexometer	125
FOMON Alar retractor	163
FOMON GUBISCH HM Nasal rasp	161
FOMON Hook	241
FOMON Nasal rasp	158
FOMON Osteotomes	191
FOMON Rhinoplasty scissors	144-145
Forceps bayonet	149
Forceps blepharoplasty	242
Forceps cartilage grasping	57, 149
Forceps cartilage morselizer	196
Forceps columella	155
Forceps delicate	45-48
Forceps dressing	45-46, 48-49, 200
Forceps ethmoid bone	170
Forceps grasping	55-57, 149, 247
Forceps hemostatic	73-76
Forceps HM	31, 35
Forceps micro	50-53
Forceps morselizer	196-197
Forceps nasal	169-170
Forceps nasal dressing	167
Forceps nasal septum	168, 172-173
Forceps septum	172-173
Forceps suturing	54
Forceps tendon interlacing	259



Forceps tendon tunneling	258
Forceps tissue	45-49
Forceps tissue grasping	55-57, 149
Forceps titanium	53
Forceps wire twisting	250
FOX Gum scissors	36
FOX Tissue grasping forceps	48-49, 56-57
FRAMER Tendon passers	260
FRAZIER Delicate retractor	84
FREEMAN GORNEY Dissecting scissors	33
FREEMAN METZENBAUM Dissecting scissors	28
FREER Delicate retractor	151
FREER Elevators	175
FREER Mucosa knife	178
FREER OBWEGESER Raspatories	110
FREER Raspatory	179
FREER Septum gouges	184
FUNKE Hand fixation plate	266
G	
Gags mouth	122-124
Gauge rod	199
GILLIES Delicate retractors	85
GILLIES HM Needle holder	66
GILLIES Needle holder	66
GILLIES Tissue forceps	48
GILLIES-SLIM HM Needle holder	66
GILLIES-SLIM Needle holder	66
GIUNTA Rhinoplasty scissors	146
Glass-barrel syringes	226, 228
GOLDMAN Septum fracture elevator	176
Goniometer	125
GORNEY Dissecting scissors	32
GORNEY-FREEMAN Dissecting scissors	33
GORNEY Rhinoplasty scissors	148
Gouges	184
Gouges septum	184
GRAEFE ADSON Tissue forceps	47
Grasping forceps	55-57, 247
Grasping forceps lid	56
GREEN LANGENBECK Delicate retractors	83, 241
GREEN SENN Delicate retractors	82
GREENBERG PAR Delicate dissecting scissors	14
GROSS Dressing forceps	200
GRUENWALD Bayonet forceps	149
GUBISCH AIACH Forceps	196
GUBISCH-AUFRICHT Nasal retractors	165
GUBISCH Blepharoplasty forceps	242
GUBISCH Cartilage crusher	194
GUBISCH COTTLE Chisels	185
GUBISCH DANIEL Raspatories	105-107

GUBISCH FANOUS Osteotome	190
GUBISCH-FOMON HM Nasal rasp	161
GUBISCH HM Needle holder	150
GUBISCH-KILNER Alar retractor	162
GUBISCH Osteotomes	188
GUBISCH Pen holder	126, 198
GUBISCH-RUBIN HM Septal morselizer forceps	197
GUBISCH Suction raspatories	182
GUILLEN Mallet	183
Gum scissors	36
GUTHRIE Delicate retractors	152
H	
HALLE TIECK Nasal specula	153
HALSEY HM Needle holder	61
HALSEY Needle holder	61
HALSTED MICRO Hemostatic forceps	74
HALSTED-MOSQUITO Hemostatic forceps	76
Hand fixation plate	266
Handle	264
Handles for cannulas	222, 233
HANNA Tongue spatula	122
HARALDSSON Suction elevator	176
HARGIS Raspatory	108
HARTMANN Nasal dressing forceps	167
HARTMANN Nasal specula	153
HEERMANN Handle	264
HEGAR MAYO HM Needle holders	63
HEGAR MAYO Needle holders	62
Hemostatic forceps	73-76
HEYMANN Nasal septum forceps	168
HEYMANN Rhinoplasty scissors	142
HINDERER Cartilage grasping forceps	149
HM Forceps	26-27
HM Needle holders	60-61, 63-69, 150
HOEFERT DENHART Mouth gag	122
Holding device for syringes	228
Hook dissectors	203
Hook fistula	86
Hook scissors	247
Hooks cleft palate	118
Hooks dura	84
Hooks nerve	246
Hooks skin	84, 86, 162
Hooks tracheal	87
HOSPITAL PROVIDENCE Hemostatic forceps	75
HOUGH Rhinoplasty scissors	147
HUDSON-EWALD Dressing forceps	45



Alphabetischer Index
Alphabetical Index
Índice alfabético
Index alphabétique
Índice alfabético

N02

HUDSON-EWALD Tissue forceps	45
HUMBY Delicate retractor	85
HUMBY Dermatome	139
Hypodermic needles	210,230
I	
Iliac crest retractors	97
Infiltration cannulas	210
Infiltration pump for liposuction	234
Injection cannulas	210, 230
Instrument maintenance oils	274
Instrument mat, magnetic	273
Interdental osteotomes	111
IRIS Delicate scissors	9-11
IRIS MICRO Delicate scissors	11
Iris scissors	9-11
J	
JABALEY Delicate scissors	8
JACKSON Delicate retractor	81
JACKSON Tracheal hook	87
JACOBSON HM Micro needle holders	69
JACOBSON MICRO 2000 Micro scissors	39
JACOBSON MICRO Hemostatic forceps	74
JACOBSON Micro needle holders	69
JAMESON Caliper	125
JAMESON Delicate dissecting scissors	17
JAMESON REYNOLDS Dissecting scissors	30
JANSEN Curette	107
JOSEPH-DANIEL Dissecting scissors	29
JOSEPH Delicate dissecting scissors	15
JOSEPH Delicate retractors	151, 152
JOSEPH Gauge rod	199
JOSEPH Nasal saws	171
JOSEPH PECK Delicate dissecting scissors	15
JOSEPH Rhinoplasty knives	174
JOSEPH Rhinoplasty scissors	147
JOSEPH Septum cartilage knife	174
JOSEPH-MASING Septum raspator	107
K	
KAHRE Cleft palate raspator	118
KASTEN Coriotome	138
KAYE Dissecting scissors	31, 35
KELLY Dissecting scissors	29
KELLY Stitch scissors	44
KELLY BRÜSER Delicate dissecting scissors	18
KILLIAN-CLAUS Septum gouge	184
KILLIAN Nasal specula	154
KILLIAN Septum gouge	184
KILNER Alar retractor	162
KILNER GUBISCH Alar retractor	162

KILNER RAGNELL Delicate dissecting scissors	14
KISTLER Anthelix cartilage files	253, 254
KLEINERT-KUTZ Delicate retractors	86
KLEINERT-KUTZ Tendon tunneling forceps	258
KNAPP Delicate dissecting scissors	12-13
Knife cartilage	174
Knife inserts	264
Knife mucosa	178
Knives	264
Knives rhinoplasty	174
Knives sculpture	250
KOCHER Retractors	91
KOSHIMA CASTROVIEJO Micro needle holders	68
KOSHIMA MICRO JACOBSON Hemostatic forceps	75
KOSHIMA Micro Scissors	37
KOTZUR Liposuction cannula	217
KRETSCHMER Reference pin	129
KUTZ KLEINERT Delicate retractors	86
KUTZ KLEINERT Tendon tunneling forceps	258
L	
LAHEY-CLINIC Delicate retractor	84
LANDOLT Scalpel handles	4
LANGENBECK Elevator	175
LANGENBECK-GREEN Delicate retractors	83, 241
LANGENBECK PARKER (US ARMY) Retractors	89
LANGENBECK Retractors	91
LANGENBECK Rhinoplasty knives	174
LEMPERT Raspatories	105
LERICHE Hemostatic forceps	76
LEWIS HM Nasal rasp	158
LEWIS Nasal rasp	157
LEXER-BABY Delicate dissecting scissors	12
LEXER Dissecting scissors	20
LEXER MAYO Dissecting scissors	20
Lid grasping forceps	56
Lid retractors	93
Ligature needles	246
Ligature scissors	42
LINDEMANN Cutting burr	196
Lip instruments	118-120
Lip retractors	121
Lipoinjection dosage handles	229
Liposuction cannulas	212-221
LITTAUER Stitch scissors	44
LITTLER Suture carrying scissors	143
LUBET-BARBON Nasal dressing forceps	167
LUC-BRÜNINGS (HEYMANN) Nasal septum forceps	168



M	
MAGGY Instrument mat, magnetic	273
Mallets	183
MALTZ Nasal rasp	156
Mandibular rim retractor	93
Marking instruments	125-129, 199
MARX Breast retractors	205
MASING Alar retractor	163
MASING COTTLE Mucosa needle holders	67
MASING COTTLE Rhinoplasty scissors	143
MASING JOSEPH Septum raspatory	107
MASING Nasal file	161
MASING Nasal rasp	161
MASING Septum elevator	177
MATHIEU HM Needle holders	67
Maxilla mobilizer	115
MAYO Dissecting scissors	19
MAYO-HEGAR HM Needle holders	63
MAYO-HEGAR Needle holders	62
MAYO-LEXER Dissecting scissors	20
MAYO-STILLE Dissecting scissors	21
McINDOE Cartilage scissors	144
McINDOE Chisels	187
McINDOE Cleft palate raspatory	118
McINDOE Dressing forceps	48
McKENTY COTTLE Raspatory	181
McKENTY Raspatories	179
McKESSON Mouth gags	124
Measuring instruments	125-129, 199
Medicontainer	268-269
MERCEDES Liposuction cannulas	217
MERSHON Wire positioner	136
METZENBAUM BABY Delicate dissecting scissors	17, 18
METZENBAUM Dissecting scissors	22-23, 28
METZENBAUM-FREEMAN Dissecting scissors	28
METZENBAUM MINI Delicate dissecting scissors	18
METZENBAUM NELSON Dissecting scissors	24-25
METZENBAUM-SLIM Dissecting scissors	26-27
MEYERDING Delicate retractors	82
MICRO 2000 JACOBSON Micro scissors	39
MICRO 2000 (KOSHIMA) Micro forceps	51
MICRO 2000 Micro forceps	50-52
MICRO 2000 Micro needle holders	69-70
MICRO 2000 Micro scissors	37-40
MICRO 2000 Suturing forceps	54
Micro compass saw	133
Micro forceps	50-53
Micro needle holders	68-72
Micro oscillating saw	130
Micro sagittal saw	131

Micro saws	130-135
Micro scissors	37-41
Micro vessel clips	77-80
MICRO-ADSON Dressing forceps	47
MICRO-ADSON Tissue forceps	47
MICRO CASTROVIEJO Needle holders	68
MICRO-HALSTED Hemostatic forceps	74
MICRO-IRIS Delicate scissors	11
MICRO-JACOBSON Hemostatic forceps	74
MICRO-JACOBSON (KOSHIMA) Hemostatic forceps	75
MILLARD (COTTLE) Alar retractor	163
MILLER SENN Delicate retractors	81
MINI-METZENBAUM Delicate dissecting scissors	18
MOBERG Chisels	187
Mobilizer maxilla	115
MOD. LANZ Bone holding forceps	257
MOD. LANZ Bone piercer	256
MOD. LANZ Tendon stripper	261
MOD. WIEN Nasal specula	153
MOD. LANZ Delicate retractor	83
Model surgery articulator	128
MOLT Mouth gags	122
MÖLTGEN Flexometer	125
Morselizer forceps	196-197
MOSQUITO AT Hemostatic forceps	74
MOSQUITO HALSTED Hemostatic forceps	76
Mouth gags	122-124
Mucoperiost retractors	119
Mucosa knife	178
Mucosa needle holders	67
N	
NAGATA Elevators	104, 252
NAGATA HM Needle holders	60
NAGATA Sculpture knives	250
Nasal dressing forceps	167
Nasal files	161
Nasal forceps	169-170
Nasal fracture elevator	175
Nasal rasps	156-161
Nasal retractors	81, 164-166
Nasal ridge scissors	148
Nasal saws	171
Nasal septum forceps	168, 172-173
Nasal septum osteotomes	193
Nasal septum scissors	146, 148
Nasal septum speculum	155
Nasal specula	153-155
Nasal spine retractor	96
Navel marker	237



Alphabetischer Index
Alphabetical Index
 Índice alfabético
 Index alphabétique
 Índice alfabético

N02

ENGLISH

Needle holders	58-72, 150
Needle holders HM	60-61, 63-69, 150
Needle holders HM explanations	58
Needle holders micro	68-72
Needle holders mucosa	67
Needle holders titanium	72
Needle holders with scissors	66
Needles hypodermic	210, 230
Needles ligature	246
NEIVERT Alar retractor	163
NEIVERT COTTLE Alar retractor	163
NEIVERT HM Needle holder	60
NEIVERT Needle holder	59
NELSON-METZENBAUM Dissecting scissors	24-25
NELSON Tissue grasping forceps	55
Nerve hooks	246
NEWS Tracheal hook	87
NIRO HM Wire twisting forceps	250
Nose tip markers	199
O	
O'BRIEN Stitch scissors	44
OBWEGESER Blade osteotomes	113
OBWEGESER Bone bending pliers	116
OBWEGESER Channel retractors	98
OBWEGESER Chin retractor	98
OBWEGESER-FREER Raspatories	110
OBWEGESER HM Wire twister	136
OBWEGESER Iliac crest retractors	97
OBWEGESER Interdental osteotomes	111
OBWEGESER Mandibular rim retractor	93
OBWEGESER Maxilla mobilizer	115
OBWEGESER Model surgery articulator	128
OBWEGESER Nasal rasps	159
OBWEGESER Nasal ridge scissors	148
OBWEGESER Nasal septum forceps	173
OBWEGESER Nasal septum osteotomes	193
OBWEGESER Nasal spine retractor	96
OBWEGESER Osteotomes	111-113
OBWEGESER Pterygoid osteotome	111
OBWEGESER Ramus retractors	94
OBWEGESER Raspatories	108-109
OBWEGESER Rib raspatories	106
OBWEGESER Soft tissue retractors	95
OBWEGESER Splitting osteotomes	112
OBWEGESER Wedge osteotomes	112
OBWEGESER Wire loop forceps	136
OBWEGESER Wisdom tooth retractor	96
Operating scissors	43
Optics	248, 263
Orbita floor raspatory	110
Orbital osteotomes	115

Osseoscalpel	132
Osteotome pterygoid	111
Osteotomes	111-115, 186-193
Osteotomes blade	113
Osteotomes cylinder	114
Osteotomes interdental	111
Osteotomes nasal septum	193
Osteotomes orbital	115
Osteotomes splitting	112, 191
Osteotomes wedge	112
P	
PARKER-LANGENBECK (US ARMY) Retractors	89
PEAN Hemostatic forceps	74
PECK-JOSEPH Delicate dissecting scissors	15
Pen for marking	126
Pen holder	126, 198
PENNINGTON Elevator	104
Phalanx holding forceps	257
PITANGUY Facelift marker	127
Plastic syringes	210, 226, 230, 233
Pliers bone bending	116
Preparation plate	138
Probe	256
PROVIDENCE-HOSPITAL Hemostatic forceps	75
Pterygoid osteotome	111
R	
RAGNELL Delicate retractor	81
RAGNELL (KILNER) Delicate dissecting scissors	14
Ramus retractors	94
Rasp	133
Raspatories	105-110, 179-182, 244
Raspatories cleft palate	118, 120
Raspatories rib	106, 251
Raspatories suction	182
Raspatory orbital floor	110
Raspatory septum	107
Raspatory tunneling	181
Rasps nasal	156-161
Reference pin	129
Retractor abdominal	236
Retractor chin	98
Retractor mandibular rim	93
Retractor nasal spine	96



Retractor wisdom tooth	96
Retractor with channel for endoscope	248
Retractors with fiber optic illumination	92, 166
Retractors	81-88
Retractors alar	162-164
Retractors breast	205
Retractors channel	98
Retractors cheek	121
Retractors delicate	81-88, 151-152, 241
Retractors iliac crest	97
Retractors lip	121
Retractors mucoperiost	119
Retractors nasal	81, 164-166
Retractors ramus	94
Retractors self-retaining	99-101
Retractors soft tissue	95
REYNOLDS (JAMESON) Dissecting scissors	30
Rhinoplasty knives	174
Rhinoplasty scissors	142-148
Rib raspatories	106, 251
Rongeurs bone	257
Round bowl	204
RUBIN GUBISCH HM Septal morselizer forceps	197
RUBIN HM Septal morselizer forceps	197
RUBIN Osteotomes	186, 191
RUBIN Septal morselizer forceps	197
Rulers	125
RUSS. MOD. Tissue grasping forceps	55
S	
SACHSE Micro oscillating saw	130
SACHSE Micro sagittal saw	131
SACHSE Osseoscalpel	132
SALDANHA-SOLZ Abdominal retractor	236
Saw blades	130-133
Saws micro	130-135
Saws nasal	171
Scalpel blades	2-4
Scalpel handles	2-4
Scalpels	2-4
SCHINK Dermatome	140
SCHROM Osteotomes	190
Scissors	5-44
Scissors blepharoplasty	31
Scissors Bulldog	143
Scissors cartilage	144
Scissors delicate	8-18
Scissors dissecting	12-35
Scissors explanations	6
Scissors gum	36

Scissors hook	247
Scissors iris	9-11
Scissors ligature	42
Scissors micro	37-41
Scissors nasal ridge	148
Scissors nasal septum	146, 148
Scissors operating	43
Scissors rhinoplasty	142-148
Scissors stitch	43-44
Scissors suture carrying	143
Scissors tunneling	15, 31
Scissors wire cutting	251
Sculpture knives	250
Self-retaining retractors	99-101
SEMKEN Dressing forceps	48
SEMKEN Tissue forceps	48
SENN-GREEN Delicate retractors	82
SENN-MILLER Delicate retractors	81
SENNING HM Needle holders	65
SENNING Needle holder	65
Septal morselizer forceps	197
Septum cartilage knife	174
Septum elevators	177
Septum forceps	172-173
Septum fracture elevator	176
Septum gouges	184
Septum raspatory	107
Septum straightening forceps	172-173
SHEA Delicate dissecting scissors	14
SHEPARD Cylinder osteotomes	114
SIEGERT Undermining scissors	15
SILVER Dermatome	140
SILVER Osteotomes	192
Skin hooks	84, 86, 162
Skin stretching plate	140
SLIM Delicate dissecting scissors	16
SLIM GILLIES HM Needle holder	66
SLIM GILLIES Needle holder	66
SLIM METZENBAUM Dissecting scissors	26-27
Soft tissue retractors	95
SOLZ Areola marker	204
SOLZ Atraumatic breast dissectors	202
SOLZ Dissecting scissors	34
SOLZ Hook dissectors	203
SOLZ Navel marker	237
SOLZ SALDANHA Abdominal retractor	236
Spare blade for coriotome	138
Spare blades for dermatomes	139-140
Spatulas tongue	122, 200
Specula nasal	153-155
Speculum nasal septum	155
SPENCER Stitch scissors	43



Alphabetischer Index
Alphabetical Index
Índice alfabético
Index alphabétique
Índice alfabético

N02

ENGLISH

Splitting osteotomes	112, 191
Spray oil	274
Spreader finger	256
STEINHÄUSER Orbita floor raspatory	110
STEINHÄUSER Orbital osteotomes	115
STEINMANN Tendon grasping forceps	257
STELLBRINK Bone rongeurs	257
Sterilization containers	268-269
STERNBERG Cheek retractor	121
STEVENS Delicate dissecting scissors	13, 17
STEVENS Delicate scissors	8, 10
STILLE MAYO Dissecting scissors	21
STILLE STRANDELL Delicate retractors	83, 241
Stitch scissors	43-44
Stop for syringes	226
STRAIGHT Delicate retractor	84
STRANDELL-STILLE Delicate retractors	83, 241
Stretching plate skin	140
Suction curette axilla	232
Suction elevators	176
Suction raspatories	182
SULSENTI WINTER HM Needle holder	150
Suture carrying scissors	143
Suturing forceps	54
Syringes	210, 226, 228, 230, 233
Syringes for infiltration	210
T	
TEBBETTS Retractors	92
Tendon grasping forceps	257
Tendon interlacing forceps	259
Tendon passers	260
Tendon stripper	261
Tendon tunneling forceps	258
TESSIER Osteotomes	113
TESSIER Raspatories	110
THOMSON-WALKER (BOZEMANN) Needle holder	65
THORPE Caliper	125
TIECK-HALLE Nasal specula	153
Tissue forceps	45-49
Tissue grasping forceps	55-57, 149
Tissue holding forceps	56
Titanium forceps	53
Titanium micro needle holders	72
Titanium needle holders	72
TOENNIS-ADSON Dissecting scissors	27
TOLEDO Cannula for autologous fat transfer	224
TOLEDO Liposuction cannulas	216
Tongue depressor	123
Tongue spatulas	122, 200

Towel clamp	200
Tracheal hooks	87
Transfer adaptor	229
Trays for delicate instruments	270-271
Trays for endoscopes	272
Trocars	114
TROELTSCH (WILDE) Tissue grasping forceps	56
TSCHOEPE Cartilage morselizer forceps	196
Tunneling scissors	15, 31
Tunneling raspatory	181
Twisting forceps	215

U

UNIV. MINNESOTA CAWOOD Cheek retractor	121
UNIVERSAL HM Wire cutting scissors	251
UNIVERSAL WALSHAM Septum straightening forceps	172
US ARMY Retractors	89

V

V dissector	232
Vacuum glass-barrel syringes	226, 228
Vessel clips micro	77-80
Vomer forceps	168
VON GREGORY Cannulas for autologous fat transfer	224-225
VON GREGORY Infiltration cannula	210

W

WALKER THOMSON (BOZEMANN) Needle holder	65
WALSHAM Septum straightening forceps	172
WALSHAM UNIVERSAL Septum straightening forceps	172
WALTER AUFRIEHT Nasal retractors	166
WALTER Chisel	186
WALTER COPE Nasal retractor	81
WALTER-COTTLE Rhinoplasty scissors	146
WALTER Lid grasping forceps	56
WALTER Osteotomes	187
WALTER Retractor	89
WALTER Retractor with fibre optic illumination	166
WALTER Rhinoplasty scissors	145
WANG Mouth gag	123
WANG Raspatories	120
WATSON Dermatome	139
WAUGH Dressing forceps	49
WAUGH Tissue forceps	49
Wedge osteotomes	112
WEIL-BLAKESLEY Ethmoid bone forceps	170
WEIL-BLAKESLEY Nasal forceps	169-170

WEITLANER Self-retaining retractors	100-101
WERTHEIM BOZEMANN HM Needle holders	65
WESTMACOTT Nasal dressing forceps	167
WIENER MOD. Nasal specula	153
WILDE TROELTSCH Tissue grasping forceps	56
WILLIGER Curette	107
WILLIGER Raspatories	179
WINTER COTTLE Tissue grasping forceps	149
WINTER Rhinoplasty scissors	147
Wire cutting scissors	251
Wire instruments	136
Wire loop forceps	136
Wire pusher	136
Wire twister	136
Wire twisting forceps	250
Wires	137
Wisdom tooth retractor	96
WOOD CRILE HM Needle holders	64
WOOD CRILE Needle holders	64
WRIGHT (DERF) HM Needle holder	61
WRIGHT (DERF) Needle holder	61
Y	
YANKAUER Septum elevator	177



A	
Abrebocas	122-124
Aceites para el mantenimiento de instrumentos	274
Aproximadores	79
Micro clips vasculares	77, 79
Pinzas para aplicar para micro clips	77, 79
Adaptador	210, 226, 229
Adaptador de transferencia	229
ADSON-BROWN Pinzas quirúrgicas	47
ADSON-GRAEFE Pinza quirúrgica	47
ADSON HM Pinzas anatómicas	45
ADSON HM Pinzas quirúrgicas	46
ADSON MICRO Pinzas anatómicas	47
ADSON MICRO Pinzas quirúrgicas	47
ADSON Pinza anatómica	45
ADSON Pinzas quirúrgicas	46
ADSON Separadores finos	85
ADSON TOENNIS Tijeras para disección	27
Agente antiempañante para endoscopios	274
Agujas para ligaduras	246
AIACH Pinza	196
AIACH-GUBISCH Pinza	196
Alambre	137
Alambre de fijación con agujas	252
Alambre para huesos	137
ALAMUTI Pinza para agarrar tejidos	149
ALM Separadores autoestáticos	100
Aproximadores	78-80
Arcos de alambre	137
Articulador para cirugía modelo	128
ASCH Pinza para enderezar el tabique nasal	173
AUFRICHT-DANIEL Separador nasal	165
AUFRICHT GUBISCH Separadores nasales	165
AUFRICHT Raspadores nasales	158
AUFRICHT Separadores nasales	164-165
AUFRICHT Tijeras para rinoplastia	144
AUFRICHT-WALTER Separadores nasales	166
B	
BABY FARABEUF Separador	90
BABY LEXER Tijeras finas para disección	12
BABY-METZENBAUM Tijeras finas para disección	17, 18
BACKHAUS Pinza de campo	200
Bajalengua	123
BALLENGER Gubias para el tabique nasal	184
Bandeja de fijación de la mano	266
Bandejas para endoscopios	272
Bandejas para instrumentos delicados	270-271
BARBON LUBET Pinza nasal para tamponamiento	167
BARRAQUER Micro porta-agujas	68

BARSKY Separadores finos	86
Base de preparación	138
BENICKE Separadores finos	87
BERGMANN Separador fino	86
BIEMER Aproximadores	78, 80
BIEMER Micro clips vasculares	78
BIEMER Pinzas para aplicar	78
BIG RING BABY-METZENBAUM Tijeras finas para disección	17
BIG RING METZENBAUM BABY Tijeras finas para disección	17
BIG RING STEVENS Tijeras finas para disección	17
BIG RING Tijeras para iridectomía	11
Bisturíes	2-4
BLAKE Mango de bisturi	2
BLAKESLEY Pinzas nasales	169
BLAKESLEY WEIL Pinzas nasales	169-170
BLAKESLEY WEIL Pinzas para hueso etmoidal	170
BLOCKSMA Ganchitos para fisuras paladares	118
Bloques para cortar cartílago	195
BLUME Osteotómo	192
BOIES Elevador para fracturas nasales	175
Bomba de infiltración para la liposucción	234
BOZEMANN THOMSON-WALKER Porta-aguja	65
BOZEMANN (WERTHEIM) HM Porta-agujas	65
BRAND Enucleadores de tendones	261
BRAND Pinzas conductoras para tendones	258
BROWN ADSON Pinzas quirúrgicas	47
BRÜNINGS LUC (HEYMANN) Pinzas para el tabique nasal	168
C	
ÇAKIR Osteotómo	189
ÇAKIR DANIEL Legras	180
Calibradores	125
Calibre	199
Cánulas de infiltración	210
Cánulas de inyección	210, 230
Cánulas de liposucción	212-221
Cánulas para extracción de grasa autóloga	224-225
Cánulas para lipoinyección	223
CAPLAN Tijera para el tabique nasal	146
CASTROVIEJO Compases	127, 199, 242
CASTROVIEJO-EPKER Compases	128
CASTROVIEJO HM MICRO Porta-agujas	68



CASTROVIEJO (KOSHIMA) Micro porta-agujas	68
CASTROVIEJO-MICRO Porta-agujas	68
CAWOOD UNIV. MINNESOTA Separador de mejilla	121
Cinceles	185-187
CINELLI Osteótomos	192
CINELLI Tijera para rinoplastia	143
Clamps Bulldog	73
CLAUDINHA Espátula bucale	122
CLAUS KILLIAN Gubia para el tabique nasal	184
CLINIC LAHEY Separador fino	84
Clips vasculares	77-80
COHEN Elevador	104
COLLIER Porta-aguja	59
Compás de hueso	127
Compases	127-128, 199, 242
Contenedores para la esterilización	268-269
CONVERSE Cuchillo para rinoplastia	174
CONVERSE-DANIEL Tijera para disección	142
CONVERSE DERF Porta-aguja	62
CONVERSE HM Porta-aguja	60
CONVERSE Legra	107
CONVERSE Lima nasal	161
CONVERSE Porta-aguja	59
CONVERSE Separador para las alas nasales	162
CONVERSE Tijera para rinoplastia	143
COPE Separador fino	81
COPE-WALTER Separador nasal	81
Coriotomo	138
COTTLE Cinceles	185
COTTLE Cuchillos para rinoplastia	174
COTTLE-DANIEL Legra	180
COTTLE Elevador	175
COTTLE Elevador óseo y osteotomo hendedor	191
COTTLE Elevadores para el tabique nasal	177
COTTLE Especulo para el septo nasal	155
COTTLE Espéculos nasales	154-155
COTTLE Ganchos para la piel y las alas de la nariz	162
COTTLE-GUBISCH Cinceles	185
COTTLE HM Raspador nasal	157
COTTLE Legra tunelizadora	183
COTTLE Legras	107, 181
COTTLE Martillo	183
COTTLE-MASING Porta-agujas para mucosa	67
COTTLE-MASING Tijeras para rinoplastia	143
COTTLE-McKENTY Legra	181
COTTLE MILLARD Separador para las alas nasales	163
COTTLE-NEIVERT Separador para las alas nasales	163
COTTLE Osteótomos	186, 189

COTTLE Pinza para agarrar tejidos	149
COTTLE Pinza para columela	155
COTTLE Raspador nasal	157
COTTLE Separador fino	87
COTTLE Separadores para las alas nasales	162-164
COTTLE Tijera Bulldog	143
COTTLE Tijera para el tabique nasal	148
COTTLE Tijeras para rinoplastia	143, 145, 147-148
COTTLE Trituradora de sustancia cartilaginosa	194
COTTLE WALTER Tijeras para rinoplastia	146
COTTLE-WINTER Pinza para agarrar tejidos	149
CRAIG Pinza para el vómer	168
CRAIG-DOMNICK Pinzas para el vómer	168
CRILE Separadores finos	85, 152
CRILE-WOOD HM Porta-agujas	64
CRILE-WOOD Porta-agujas	64
Cubeta	204
Cucharillas	107
Cuchillo para cartilago del tabique nasal	174
Cuchillo para mucosa	178
Cuchillos	264
Cuchillos para modelar	250
Cuchillos para rinoplastia	174
Cureta de aspiración para la axila	232

D

DANIEL AUFRIEDT Separador nasal	165
DANIEL-ÇAKIR Legras	180
DANIEL CONVERSE Tijera para disección	142
DANIEL COTTLE Legra	180
DANIEL-GUBISCH Legras	105-107
DANIEL JOSEPH Tijeras para disección	29
DANIEL Punzón	152
DANIEL Tijera para disección	29
DAUTREY Arco de alambre	137
DEAN Tijeras para encías	36
DEBAKEY AT Pinza para agarrar tejidos	55
DEBAKEY HM Porta-agujas	64
DENHART Abreboca	122
DENHART-HOEFERT Abreboca	122
DERF WRIGHT HM Porta-aguja	61
DERF WRIGHT Porta-aguja	61
DERF-CONVERSE Porta-aguja	62
Dermatomos	139-140
DESMARRES Separadores para párpados	93, 241
DIETHRICH Clamps Bulldog	73
DINGMAN Abreboca	123
DINGMAN Legra	109
DINGMAN Rascadores de cartilago	156
Disector V	232
Disectores	244-245



Disectores de gancho	203
Disectores mamario atraumático	202
Disectores mamaros	202-203
DOMNICK CRAIG Pinzas para el vómer	168
DOROW Cureta de aspiración para la axila	232
DOROW Disector V	232
DOYEN Legras para costillas	251

E

Elevador mamario	204
Elevador óseo	191
Elevador para fracturas nasales	175
Elevadores	104, 175-177, 245, 252
Elevadores aspiradores	176
Elevadores para el tabique nasal	177
Elevador para fracturas del tabique nasal	176
EMMET Separador fino	86
Empalmes de cánulas	208
Endoscopios	248, 263
ENTNER Agujas para ligaduras	246
ENTNER Cánulas de liposucción	212-214
Enucleador de tendones	261
EPKER CASTROVIEJO Compases	128
ERICH Arcos de alambre	137
Escofina	133
Espátulas bucales	122, 200
Especulo para el septo nasal	155
Espéculos nasales	153-155
Estera para instrumentos, magnética	273
Estilet	256
EWALD HUDSON Pinza anatómica	45
EWALD HUDSON Pinza quirúrgica	45

F

FANOUS-GUBISCH Osteótomo	190
FANOUS Osteótomos	190
FANOUS Tijeras para disección	31
FANOUS Tijeras para rinoplastia	145
FANOUS Tijeras para tunelización	31
FARABEUF-BABY Separador	90
FARABEUF Separador	90
FINSEN Separadores autoestáticos	99
FOMON Gancho	241
FOMON GUBISCH HM Raspador nasal	161
FOMON Osteótomos	191
FOMON Raspador nasal	158
FOMON Separador para las alas nasales	163
FOMON Tijeras para rinoplastia	144-145
FOX Pinzas para agarrar tejidos	48-49, 56-57
FOX Tijeras para encias	36
FRAMER Pasadores de tendones	260

FRAZIER Separador fino	84
FREEMAN GORNEY Tijeras para disección	33
FREEMAN METZENBAUM Tijeras para disección	28
FREER Cuchillo para mucosa	178
FREER Elevadores	175
FREER Gubias para el tabique nasal	184
FREER Legra	179
FREER OBWEGESER Legras	110
FREER Separador fino	151
Fresas	196
FUNKE Bandeja de fijación de la mano	266

G

Ganchito fistular	86
Ganchitos para duramadre	84
Ganchitos para fisuras paladares	118
Ganchitos para nervios	246
Ganchitos para piel	84, 86, 162
Gancho de mentón	98
Ganchos para las alas de la nariz	162
Ganchos traqueales	87
GILLIES HM Porta-aguja	66
GILLIES Pinza quirúrgica	48
GILLIES Porta-aguja	66
GILLIES Separadores finos	85
GILLIES-SLIM HM Porta-aguja	66
GILLIES-SLIM Porta-aguja	66
GIUNTA Tijeras para rinoplastia	146
GOLDMAN	
Elevador para fracturas del tabique nasal	176
Goniómetro	125
Goniómetro para dedos	125
GORNEY-FREEMAN Tijeras para disección	33
GORNEY Tijera para rinoplastia	148
GORNEY Tijeras para disección	32
GRAEFE ADSON Pinza quirúrgica	47
GREEN LANGENBECK Separadores finos	83, 241
GREEN SENN Separadores finos	82
GREENBERG PAR Tijeras finas para disección	14
GROSS Pinza para curaciones	200
GRUENWALD Pinza en forma bayoneta	149
Gubias	184
Gubias para el tabique nasal	184
GUBISCH AIACH Pinzas	196
GUBISCH-AUFRIEHT Separadores nasales	165
GUBISCH COTTLE Cinceles	185
GUBISCH DANIEL Legras	105-107
GUBISCH FANOUS Osteótomo	190
GUBISCH-FOMON HM Raspador nasal	161
GUBISCH HM Porta-aguja	150
GUBISCH-KILNER	
Gancho para las alas de la nariz	162



GUBISCH Legras aspiradoras	182
GUBISCH Osteótomos	188
GUBISCH Pinza blefaroplastia	242
GUBISCH Porta-plumas	126, 198
GUBISCH-RUBIN HM Pinza para aplastamiento del tabique nasal	197
GUBISCH Trituradora de sustancia cartilaginosa	194
Guía para endoscopios	248, 263
GUILLEN Martillo	183
GUTHRIE Separadores finos	152

H

HALLE TIECK Espéculos nasales	153
HALSEY HM Porta-aguja	61
HALSEY Porta-aguja	61
HALSTED MICRO Pinzas hemostáticas	74
HALSTED-MOSQUITO Pinzas hemostáticas	76
HANNA Espátula bucale	122
HARALDSSON Elevador aspirador	176
HARGIS Legra	108
HARTMANN Espéculos nasales	153
HARTMANN Pinzas nasales para tamponiamento	167
HEERMANN Mango	264
HEGAR MAYO HM Porta-agujas	63
HEGAR MAYO Porta-agujas	62
HEYMANN Pinzas par el tabique nasal	168
HEYMANN Tijeras para rinoplastia	142
HINDERER Pinza para agarrar cartilago	149
HM Pinzas	26-27
HM Porta-agujas	60-61, 63-69, 150
HOEFERT DENHART Abreboca	122
Hoja de repuesto para coriotomo	138
Hojas de repuesto para dermatomos	139-140
Hojas de bisturí	2-4
Hojas de sierra	130-133
HOSPITAL PROVIDENCE Pinzas hemostáticas	75
HOUGH Tijera para rinoplastia	147
HUDSON-EWALD Pinza anatómica	45
HUDSON-EWALD Pinza quirúrgica	45
HUMBY Dermotomo	139
HUMBY Separador fino	85

I

Insertos para cuchillos	264
Instrumento para posicionar alambre	136
Instrumentos para alambre	136
Instrumentos para cartilago	116-117, 194-197
Instrumentos para fisuras paladares	118-120
Instrumentos para huesos	116-117, 196-197
Instrumentos para labios	118-120

Instrumentos para marcar	125-129, 199
Instrumentos para medir	125-129, 199
IRIS MICRO Tijeras finas	11
IRIS Tijeras finas	9-11

J

JABALEY Tijeras finas	8
JACKSON Gancho traqueal	87
JACKSON Separador fino	81
JACOBSON HM Micro porta-agujas	69
JACOBSON MICRO 2000 Micro tijeras	39
JACOBSON MICRO Pinzas hemostáticas	74
JACOBSON Micro porta-agujas	69
JAMESON Calibrador	125
JAMESON REYNOLDS Tijeras para disección	30
JAMESON Tijeras finas para disección	17
JANSEN Cucharilla	107
Jeringas	210, 226, 228, 230, 233
Jeringas de infiltración	210
Jeringas de plástico	210, 226, 230, 233
Jeringas de vacío de vidrio	226, 228
JOSEPH Calibre	199
JOSEPH Cuchillo para cartilago del tabique nasal	174
JOSEPH Cuchillos para rinoplastia	174
JOSEPH-DANIEL Tijeras para disección	29
JOSEPH-MASING Legra para el tabique nasal	107
JOSEPH PECK Tijeras finas para disección	15
JOSEPH Separadores finos	151, 152
JOSEPH Sierras nasales	171
JOSEPH Tijera para rinoplastia	147
JOSEPH Tijeras finas para disección	15

K

KAHRE Legra para fisura paladar	118
KASTEN Coriotomo	138
KAYE Tijeras para disección	31, 35
KELLY BRÜSER Tijeras finas para disección	18
KELLY Tijera para hilo	44
KELLY Tijeras para disección	29
KILLIAN-CLAUS Gubia para el tabique nasal	184
KILLIAN Espéculos nasales	154
KILLIAN Gubia para el tabique nasal	184
KILNER Gancho para las alas de la nariz	162
KILNER GUBISCH Gancho para las alas de la nariz	162
KILNER RAGNELL Tijeras finas para disección	14
KISTLER Limas para el cartilago del anthelix	253, 254
KLEINERT-KUTZ Pinzas conductoras para tendones	258



KLEINERT-KUTZ Separadores finos	86
KNAPP Tijeras finas para disección	12-13
KOCHER Separadores	91
KOSHIMA CASTROVIEJO Micro porta-agujas	68
KOSHIMA MICRO JACOBSON Pinzas hemostáticas	75
KOSHIMA Micro tijeras	37
KOTZUR Cánula de liposucción	217
KRETSCHMER Perno de referencia	129
KUTZ KLEINERT Separadores finos	86
KUTZ KLEINERT Pinzas conductoras para tendones	258
L	
LAHEY-CLINIC Separador fino	84
LANDOLT Mangos de bisturí	4
LANGENBECK Cuchillos para rinoplastia	174
LANGENBECK Elevador	175
LANGENBECK PARKER (US ARMY) Separadores	89
LANGENBECK Separadores	91
LANGENBECK-GREEN Separadores finos	83, 241
Legra para el piso de la órbita	110
Legra para el tabique nasal	107
Legra tunelizadora	181
Legras	105-110, 179-182, 244
Legras aspiradoras	182
Legras para costillas	106, 251
Legras para fisuras paladares	118, 120
LEMPERT Legras	105
LERICHE Pinzas hemostáticas	76
LEWIS HM Raspador nasal	158
LEXER-BABY Tijeras para disección	12
LEWIS Raspador nasal	157
LEXER MAYO Tijeras para disección	20
LEXER Tijeras para disección	20
Limas nasales	161
Limas para el cartilago del anthelix	253-254
LINDEMANN Fresa	196
LITTAUER Tijera para hilo	44
LITTLER Tijera guía-hilo	143
LUBET-BARBON Pinza nasal para tamponiamento	167
LUC-BRÜNINGS (HEYMANN) Pinzas para el tabique nasal	168
M	
MAGGY Estera para instrumentos, magnética	273
MALTZ Raspador nasal	156
Mango	264

Mangos de bisturi	2-4
Mangos para cánulas	222, 233
Mangos para dosificar la lipoinyección	229
Marcador para facelift	127
Marcadores de la punta de la nariz	199
Marcadores para aréola	204
Martillos	183
MARX Separadores mamarios	205
MASING COTTLE Porta-agujas para mucosa	67
MASING COTTLE Tijeras para rinoplastia	143
MASING Elevador para el tabique nasal	177
MASING JOSEPH Legra para el tabique nasal	107
MASING Lima nasal	161
MASING Raspador nasal	161
MASING Separador para las alas de la nariz	163
MATHIEU HM Porta-agujas	67
MAYO Tijeras para disección	19
MAYO-HEGAR HM Porta-agujas	63
MAYO-HEGAR Porta-agujas	62
MAYO-LEXER Tijeras para disección	20
MAYO-STILLE Tijeras para disección	21
McINDOE Cinceles	187
McINDOE Legra para fisura paladar	118
McINDOE Pinza anatómica	48
McINDOE Tijera para cartílagos	144
McKENTY COTTLE Legra	181
McKENTY Legras	179
McKESSON Abrebocas	124
Medicontainer	268-269
MERCEDES Cánulas de liposucción	217
MERSHON Instrumento para posicionar alambre	136
METZENBAUM BABY Tijeras finas para disección	17, 18
METZENBAUM-FREEMAN Tijeras para disección	28
METZENBAUM MINI Tijeras finas para disección	18
METZENBAUM NELSON Tijeras para disección	24-25
METZENBAUM Tijeras para disección	22-23, 28
METZENBAUM-SLIM Tijeras para disección	26-27
MEYERDING Separadores finos	82
MICRO 2000 JACOBSON Micro tijeras	39
MICRO 2000 (KOSHIMA) Micro pinza	51
MICRO 2000 Micro pinzas	50-52
MICRO 2000 Micro porta-agujas	69-70
MICRO 2000 Micro tijeras	37-40
MICRO 2000 Pinzas para sutura	54
Micro clips vasculares	77-80
Micro pinzas	50-53
Micro porta-agujas	68-72



Micro sierra de vaivén	133
Micro sierra oscilante	130
Micro sierra sagital	131
Micro sierras	130-135
Micro tijeras	37-41
MICRO-ADSON Pinzas anatómicas	47
MICRO-ADSON Pinzas quirúrgicas	47
MICRO CASTROVIEJO Porta-agujas	68
MICRO-HALSTED Pinzas hemostáticas	74
MICRO-IRIS Tijeras finas	11
MICRO-JACOBSON (KOSHIMA) Pinzas hemostáticas	75
MICRO-JACOBSON Pinzas hemostáticas	74
MILLARD (COTTLE) Separador para las alas nasales	163
MILLER SENN Separadores finos	81
MINI-METZENBAUM Tijeras finas para disección	18
MOBERG Cinceles	187
MOD. LANZ Eucleadores de tendones	261
MOD. LANZ Pinzas prensora para huesos	257
MOD. LANZ Punzone	256
MOD. WIEN Espéculos nasales	153
MOD. LANZ Separador fino	83
MOLT Abrebocas	122
MÖLTGEN Goniómetro	125
MOSQUITO AT Pinzas hemostáticas	74
MOSQUITO HALSTED Pinzas hemostáticas	76
Movilizador maxilar	115
N	
NAGATA Cuchillos para modelar	250
NAGATA Eelevadores	104, 252
NAGATA HM Porta-agujas	60
NEIVERT COTTLE Separador para las alas nasales	163
NEIVERT HM Porta-aguja	60
NEIVERT Porta-aguja	59
NEIVERT Separador para las alas nasales	163
NELSON Pinzas para agarrar tejidos	55
NELSON-METZENBAUM Tijeras para disección	24-25
NEWS Gancho traqueal	87
NIRO HM Pinza tensora de alambre	250
O	
O'BRIEN Tijera para hilo	44
OBWEGESER Articulador para cirugía modelo	128
OBWEGESER FREER Legras	110
OBWEGESER Gancho de mentón	98
OBWEGESER HM Pinza para torcer alambre	136
OBWEGESER Legras	108-109
OBWEGESER Legras para costillas	106
OBWEGESER Movilizador maxilar	115

OBWEGESER Osteótomo pterigoideo	111
OBWEGESER Osteótomos	111-113
OBWEGESER Osteótomos de cuña	112
OBWEGESER Osteótomos en forma de hoja	113
OBWEGESER Osteótomos hendedores	112
OBWEGESER Osteótomos interdentes	111
OBWEGESER Osteótomos para el tabique nasal	193
OBWEGESER Pinza para aros de alambre	136
OBWEGESER Pinzas para doblar huesos	116
OBWEGESER Pinzas para el tabique nasal	173
OBWEGESER Raspadores nasales	159
OBWEGESER Separador para el borde del maxilar inferior	93
OBWEGESER Separador para muela del juicio	96
OBWEGESER Separador para espina nasal	96
OBWEGESER Separadores para cresta ilíaca	97
OBWEGESER Separadores mandibulares	98
OBWEGESER Separadores para el ramo	94
OBWEGESER Separadores para partes blandas	95
OBWEGESER Tijeras para dorso nasal	148
Opticas	248, 263
Osseoscalpel	132
Osteótomo pterigoideo	111
Osteótomos	111-115, 186-193
Osteótomos cilíndricos	114
Osteótomos de cuña	112
Osteótomos en forma de hoja	113
Osteótomos interdentes	111
Osteótomos para orbita	115
Osteótomos para el tabique nasal	193
Osteótomos para hender hueso	112, 191
P	
PARKER-LANGENBECK (US ARMY) Separadores	89
Pasadores de tendones	259
PEAN Pinza hemostática	74
PECK-JOSEPH Tijeras finas para disección	15
PENNINGTON Elevador	104
Perno de referencia	129
Pinza aplastadora	196-197
Pinza aplastadora de cartílagos	196
Pinza blefaroplastica	242
Pinza de agarrar falanges	257
Pinza de campo	200
Pinza en forma bayoneta	149
Pinza para agarrar párpados	56
Pinza para agarrar tejidos	56
Pinza para aros de alambre	136
Pinza para columela	155



Pinza para entrelazar tendones	259
Pinza para sujetar tendones	257
Pinza para torcer alambre	136
Pinza prensora para huesos	257
Pinza tensora de alambre	250
Pinzas anatómicas	45-46, 48-49
Pinzas para aplicar	77-80
Pinzas Bulldog	73
Pinzas conductoras para tendones	258
Pinzas de titanio	53
Pinzas finas	45-48
Pinzas gubias	257
Pinzas hemostáticas	73-76
Pinzas HM	31, 35
Pinzas micro	50-53
Pinzas nasales	169-170
Pinzas nasales para tamponamiento	167
Pinzas para agarrar	247
Pinzas para agarrar cartilagos	57, 149
Pinzas para agarrar tejidos	55-57, 149
Pinzas para aplastamiento del tabique nasal	197
Pinzas para curaciones	200
Pinzas para doblar huesos	116
Pinzas para el tabique nasal	168, 172-173
Pinzas para el vómer	168
Pinzas para enderezar el tabique nasal	172-173
Pinzas para hueso etmoidal	170
Pinzas para sutura	54
Pinzas prensora para huesos	257
Pinzas quirúrgicas	45-49
PITANGUY Marcador para facelift	127
Placa tensora de membrana	140
Pluma para marcar	126
Porta-agujas	58-72, 150
Porta-agujas con tijeras	66
Porta-agujas HM	60-61, 63-69
Porta-agujas HM explicaciones	58
Porta-agujas micro	68-72
Porta-agujas para mucosa	67
Porta-agujas titanio	72
Porta-plumas	126, 198
Posicionador de ombligo	237
PROVIDENCE-HOSPITAL Pinzas hemostáticas	75
Punzones	152, 256
Punzones de dilatación	265
R	
RAGNELL (KILNER) Tijeras finas para disección	14
RAGNELL Separador fino	81
Rascadores de cartilago	156
Raspadores nasales	156-161

Recipiente para colorante de marcación	204
Reglas	125
REYNOLDS (JAMESON) Tijeras para disección	30
RUBIN GUBISCH HM Pinza para aplastamiento del tabique nasa	197
RUBIN HM Pinza para aplastamiento del tabique nasal	197
RUBIN Osteotomos	186, 191
RUBIN Pinzas para aplastamiento del tabique nasal	197
RUSS. MOD. Pinza para agarrar tejidos	55
S	
SACHSE Micro sierra oscilante	130
SACHSE Micro sierra sagital	131
SACHSE Osseoscalpel	132
SALDANHA-SOLZ Separador abdominal	236
SCHINK Dermatomo	140
SCHROM Osteótomos	190
SEMKEN Pinzas anatómicas	48
SEMKEN Pinzas quirúrgicas	48
SENNING HM Porta-aguja	65
SENNING Porta-aguja	65
SENN-GREEN Separadores finos	82
SENN-MILLER Separadores finos	81
Separador abdominal	236
Separador con canal para endoscopio	248
Separador para dedos	256
Separador para el borde del maxilar inferior	93
Separador para espina nasal	96
Separador para muela del juicio	96
Separadores	81-98
Separadores autoestáticos	99-101
Separadores con iluminación de luz fría	92, 166
Separadores de labios	121
Separadores de mejillas	121
Separadores finos	81-88, 151-152, 241
Separadores finos dobles	81, 152
Separadores mamarios	205
Separadores mandibulares	98
Separadores mucoperiostales	119
Separadores nasales	81, 164-166
Separadores para cresta ilíaca	97
Separadores para el ramo	94
Separadores para las alas de la nariz	162-164
Separadores para párpados	93
Separadores para partes blandas	95
SHEA Tijeras finas para disección	14
SHEPARD Osteotomos cilíndricos	114
SIEGERT Tijeras para tunelización	15
Sierras micro	130-135



Sierras nasales	171
SILVER Dermatomy	140
SILVER Osteótomos	192
SLIM GILLIES HM Porta-aguja	66
SLIM GILLIES Porta-aguja	66
SLIM METZENBAUM	
Tijeras para disección	26-27
SLIM Tijeras finas para disección	16
SOLZ Disectores de gancho	203
SOLZ Disectores mamario atraumático	202
SOLZ Marcadores para areola	204
SOLZ Posicionador de ombligo	237
SOLZ SALDANHA Separador abdominal	236
SOLZ Tijeras para disección	34
Soporte para jeringas	228
SPENCER Tijeras para hilos	43
Spray de aceite	274
STEINHÄUSER Legra para el piso de la órbita	110
STEINHÄUSER Osteótomos orbitales	115
STEINMANN Pinza para sujetar tendones	257
STELLBRINK Pinzas gubias	257
STERNBERG Separador de mejilla	121
STEVENS Tijeras finas	8, 11
STEVENS Tijeras finas para disección	13, 17
STILLE MAYO Tijeras para disección	21
STILLE STRANDELL Separadores finos	83, 241
Stop para jeringas	226
STRAIGHT Separador fino	84
STRANDELL-STILLE Separadores finos	83, 241
SULSENTI WINTER HM Porta-aguja	150
T	
TEBBETTS Separadores	92
TESSIER Legras	110
TESSIER Osteótomos	113
THOMSON-WALKER (BOZEMANN) Porta-aguja	65
THORPE Calibrador	125
TIECK-HALLE Espéculos nasales	153
Tijera Bulldog	143
Tijera guía-hilo	143
Tijera para cartílagos	144
Tijera para cortar alambre	251
Tijera quirúrgica	43
Tijeras	5-44
Tijeras de gancho	247
Tijeras explicaciones	6
Tijeras finas	8-11
Tijeras finas para disección	12-18
Tijeras micro	37-41
Tijeras para blefaroplastia	31
Tijeras para disección	12-35

Tijeras para dorso nasal	148
Tijeras para el tabique nasal	146, 148
Tijeras para encías	36
Tijeras para hilos	43-44
Tijeras para iridectomía	9-11
Tijeras para ligaduras	42
Tijeras para rinoplastia	142-148
Tijeras para tunelización	15, 31
Titanio micro porta-agujas	72
Titanio pinzas	53
Titanio porta-agujas	72
TOENNIS-ADSON Tijeras para disección	27
TOLEDO Cánula para extracción de grasa autóloga	224
TOLEDO Cánulas de liposucción	216
Trituradora de hueso	117
Trituradora de sustancia cartilaginosa	194
Trocars	114
TROELTSCH (WILDE) Pinza para agarrar tejidos	56
TSCHOEPE Pinza aplastadora de cartílagos	196
U	
UNIVERSAL HM Tijera para cortar alambre	251
UNIV. MINNESOTA CAWOOD Separador de mejilla	121
UNIVERSAL WALSHAM Pinza para enderezar el tabique nasal	172
US ARMY Separadores	89
V	
TOLEDO Cánulas de liposucción	210
VON GREGORY Cánulas para extracción de grasa autóloga	224-225
W	
WALKER THOMSON (BOZEMANN) Porta-aguja	65
WALSHAM Pinzas para enderezar el tabique nasal	172
WALSHAM UNIVERSAL Pinza para enderezar el tabique nasal	172
WALTER AUFRICHT Separadores nasales	166
WALTER Cinceles	186
WALTER-COTTLE Tijeras para rinoplastia	146
WALTER COPE Separador nasal	81
WALTER Osteótomos	187
WALTER Pinza para agarrar párpados	56
WALTER Separador	89
WALTER Separador con iluminación de luz fría	166
WALTER Tijera para rinoplastia	145
WANG Abreboca	123
WANG Legras	120
WATSON Dermatomy	139



N03

Alphabetischer Index
Alphabetical Index
Índice alfabético
Index alphabétique
Indice alfabetico

WAUGH Pinzas anatómicas	49
WAUGH Pinzas quirúrgicas	49
WEIL-BLAKESLEY Pinzas para hueso etmoidal	170
WEIL-BLAKESLEY Pinzas nasales	169-170
WEITLANER Separadores autoestáticos	100-101
WERTHEIM BOZEMANN HM Porta-agujas	65
WESTMACOTT Pinzas nasales para tamponiamento	167
WIENER MOD. Espéculos nasales	153
WILDE TROELTSCH Pinza para agarrar tejidos	56
WILLIGER Cucharilla	107
WILLIGER Legras	179
WINTER COTTLE Pinza para agarrar tejidos	149
WINTER Tijera para rinoplastia	147
WOOD CRILE HM Porta-agujas	64
WOOD CRILE Porta-agujas	64
WRIGHT (DERF) HM Porta-aguja	61
WRIGHT (DERF) Porta-aguja	61
Y	
YANKAUER Elevador para el tabique nasal	177



A	
Abaisse-langue	123
Approximateurs	79
Micro clips vasculaires	77, 79
Pincés à appliquer pour micro clips	77, 79
Adaptateur	210, 226, 229
Adaptateur de transfert	229
ADSON-BROWN Pincés chirurgicales	47
ADSON Ecarteurs fins	85
ADSON-GRAEFE Pince chirurgicale	47
ADSON HM Pincés anatomiques	45
ADSON HM Pincés chirurgicales	46
ADSON MICRO Pincés anatomiques	47
ADSON MICRO Pincés chirurgicales	47
ADSON Pince anatomique	45
ADSON Pincés chirurgicales	46
ADSON TOENNIS Ciseaux à dissection	27
AIACH Pince	196
AIACH-GUBISCH Pincés	196
Aiguilles à ligature	246
ALAMUTI Pince à saisir les tissus	149
ALM Ecarteurs autostatiques	100
Approximateurs	78-80
Arcs en fil	137
Articulateur pour chirurgie sur modèle	128
ASCH Pince pour le redressement de la cloison nasale	173
AUFRIEHT Ciseaux pour rhinoplastie	144
AUFRIEHT-DANIEL Ecarteur nasau	165
AUFRIEHT Ecarteurs nasaux	164-165
AUFRIEHT GUBISCH Ecarteurs nasaux	165
AUFRIEHT Râpes nasales	158
AUFRIEHT-WALTER Ecarteurs nasaux	166
B	
BABY FARABEU F Ecarteur	90
BABY LEXER Ciseaux délicats pour dissection	12
BABY-METZENBAUM Ciseaux délicats pour dissection	17, 18
BACKHAUS Pince à champ	200
Baïllons	124
BALLENGER Gouges pour la cloison nasale	184
BARBON LUBET Pince à pansements pour le nez	167
BARRAQUER Micro porte-aiguilles	68
BARSKY Ecarteurs fins	86
BENICKE Ecarteurs fins	87
BERGMANN Ecarteur fin	86
BIEMER Approximateurs	78, 80
BIEMER Micro clips vasculaires	78
BIEMER Pincés à appliquer	78

BIG RING BABY-METZENBAUM Ciseaux délicats pour dissection	17
BIG RING Ciseaux à iridectomie	11
BIG RING METZENBAUM BABY Ciseaux délicats pour dissection	17
BIG RING STEVENS Ciseaux délicats pour dissection	17
Bistouris	2-4
BLAKE Manche pour bistouris	2
BLAKESLEY Pincés nasales	169
BLAKESLEY WEIL Pincés nasales	169-170
BLAKESLEY WEIL Pincés pour os ethmoïdal	170
Bloc pour couper	195
BLOCKSMA Crochets pour fissures palatines	118
Blocs pour couper le cartilage	195
BLUME Ostéotome	192
BOIES Elévateur pour fractures nasales	175
BOZEMANN THOMSON-WALKER Porte-aiguille	65
BOZEMANN (WERTHEIM) HM Porte-aiguilles	65
BRAND Décollecteurs de tendons	261
BRAND Pincés conductrices pour tendons	258
BROWN ADSON Pincés chirurgicales	47
BRÜNINGS LUC (HEYMANN) Pincés pour cloison nasale	168
BRÜSER-KELLY Ciseaux délicats pour dissection	18
BUCHWALD Spatule buccale	200
Bulldog clamps	73
BUNNELL Conducteurs de tendons	260
BUNNELL Stylet	256
C	
ÇAKIR Ostéotome	189
ÇAKIR DANIEL Rugines	180
Canules d'injection	210, 230
Canules pour l'infiltration	210
Canules pour injection d'auto-grasse	223
Canules pour le prélèvement de grasse autologue	224-225
Canules pour liposuccion	212-221
CAPLAN Ciseaux pour cloison nasale	146
Cassettes pour endoscopes	272
Cassettes pour instruments délicats	270-271
CASTROVIEJO Compas	127, 199, 242
CASTROVIEJO-EPKER Compas	128
CASTROVIEJO HM MICRO Porte-aiguilles	68
CASTROVIEJO (KOSHIMA) Micro porte-aiguilles	68
CASTROVIEJO-MICRO Porte-aiguilles	68



Alphabetischer Index
Alphabetical Index
Índice alfabético
Index alphabétique
Índice alfabético

N04

CAWOOD UNIV. MINNESOTA	
Ecarteur de joue	121
Choriotome	138
CINELLI Ciseaux pour rhinoplastie	143
CINELLI Ostéotomes	192
Ciseaux chirurgical	43
Ciseaux	5-44
Ciseaux à cartilages	144
Ciseaux à crochet	247
Ciseaux à fils	43-44
Ciseaux à iridectomie	9-11
Ciseaux à ligature	42
Ciseaux à tunnellisation	15, 31
Ciseaux Bulldog	143
Ciseaux burins	185-187
Ciseaux coupe-fil	251
Ciseaux délicats	8-11
Ciseaux délicats pour dissection	12-18
Ciseaux explications	6
Ciseaux guide-fil	143
Ciseaux micro	37-41
Ciseaux pour blépharoplastie	31
Ciseaux pour cloison nasale	146-148
Ciseaux pour dissection	12-35
Ciseaux pour le dos nasal	148
Ciseaux pour gencive	36
Ciseaux pour rhinoplastie	142-148
Clamps Bulldog	73
CLAUDINHA Spatule à langue	122
CLAUS KILLIAN Gouges pour la cloison nasale	184
CLINIC LAHEY Ecarteur fin	84
Clips vasculaires	77-80
COHEN Elévateur	104
COLLIER Porte-aiguille	59
Compas	127-128, 199, 242
Compas à os	127
Conducteurs de tendons	259
Containers pour la stérilisation	268-269
CONVERSE Ciseaux pour rhinoplastie	143
CONVERSE Couteau pour rhinoplastie	174
CONVERSE DERF Porte-aiguille	62
CONVERSE Ecarteur pour les ailes du nez	162
CONVERSE HM Porte-aiguille	60
CONVERSE Lime nasale	161
CONVERSE Porte-aiguille	59
CONVERSE Rugine	107
CONVERSE-DANIEL Ciseaux pour dissection	142
COPE Ecarteur fin	81
COPE-WALTER Ecarteur nasale	81
COTTLE Ciseaux Bulldog	143
COTTLE Ciseaux burins	185
COTTLE Ciseaux pour cloison nasale	148

COTTLE Ciseaux pour rhinoplastie	143, 145, 147-148
COTTLE Couteaux pour rhinoplastie	174
COTTLE Crochets alaires et dermiques	162
COTTLE-DANIEL Rugines	180
COTTLE Ecarteur fin	87
COTTLE Ecarteurs pour ailes du nez	162-164
COTTLE Elévateur	175
COTTLE Elévateurs pour la cloison nasale	177
COTTLE-GUBISCH Ciseaux burins	185
COTTLE HM Râpe nasale	157
COTTLE Levier à os et ostéotome fendoir	191
COTTLE Maillet	183
COTTLE-MASING Ciseaux pour rhinoplastie	143
COTTLE-MASING	
Porte-aiguilles pour suture de la muqueuse	67
COTTLE-McKENTY Rugine	181
COTTLE MILLARD	
Ecarteur pour les ailes du nez	163
COTTLE-NEIVERT	
Ecarteur pour les ailes du nez	163
COTTLE Ostéotomes	186-189
COTTLE Pince à saisir les tissus	149
COTTLE Pince pour columelle	155
COTTLE Presse pour matière cartilagineuse	194
COTTLE Râpe nasale	157
COTTLE Rugine à tunnellisation	183
COTTLE Rugine	107, 181
COTTLE Spéculum pour la cloison nasale	155
COTTLE Spéculums nasaux	154-155
COTTLE WALTER Ciseaux pour rhinoplastie	146
COTTLE-WINTER Pince à saisir les tissus	149
Coupe pour couleur de marquage	204
Couteau à cartilages de la cloison nasale	174
Couteaux	264
Couteaux à modeler	250
Couteau à muqueuse	178
Couteaux pour rhinoplastie	174
CRAIG-DOMNICK Pinces à vomer	168
CRAIG Pince à vomer	168
CRILE Ecarteurs fins	85, 152
CRILE-WOOD HM Porte-aiguilles	64
CRILE-WOOD Porte-aiguilles	64
Crochet à fistules	86
Crochets à duremère	84
Crochets à nerfs	246
Crochets à peau	84, 86, 162
Crochets alaires	162
Crochets pour fissures palatines	118
Crochets trachéaux	87
Cupule	204
Curettes	107
Curette d'aspiration pour l'aisselle	232



D	
DANIEL AUFRICT Ecarteur nasal	165
DANIEL-ÇAKIR Rugines	180
DANIEL Ciseau pour dissection	29
DANIEL CONVERSE Ciseaux pour dissection	142
DANIEL COTTLE Rugine	180
DANIEL-GUBISCH Rugines	105-107
DANIEL JOSEPH Ciseaux pour dissection	29
DANIEL Poinçon	152
DAUTREY Arc en fil	137
Davier à os	257
DEAN Ciseaux pour gencive	36
DEBAKEY AT Pince à saisir les tissus	55
DEBAKEY HM Porte-aiguilles	64
Décollecteurs de tendons	261
DENHART-HOEFERT Ouvre-bouche	122
DENHART Ouvre-bouche	122
DERF-CONVERSE Porte-aiguille	62
DERF WRIGHT HM Porte-aiguille	61
DERF WRIGHT Porte-aiguille	61
Dermatomes	139-140
DESMARRES Releveurs à paupières	93, 241
DIETHRICH Clamps Bulldog	73
DINGMAN Grattoirs à cartilages	156
DINGMAN Ouvre-bouche	123
DINGMAN Rugine	109
Dissecteur V	232
Dissecteurs	244-245
Dissecteurs crochet	203
Dissecteurs mammaire atraumatique	202
Dissecteurs mammaires	202-203
DOMNICK CRAIG Pinces à vomer	168
DOROW Curette d'aspiration pour l'aisselle	232
DOROW Dissecteur V	232
DOYEN Rugines costales	251
E	
Ecarteur à doigts	256
Ecarteur abdominal	236
Ecarteur avec canal pour endoscope	248
Ecarteur d'épine nasale	96
Ecarteur pour dent de sagesse	96
Ecarteur pour le bord du maxillaire inférieur	93
Ecarteurs	81-98
Ecarteurs à rameau	94
Ecarteurs autostatiques	99-101
Ecarteurs avec illumination à lumière froide	92, 166
Ecarteurs de joues	121
Ecarteurs de lèvres	121
Ecarteurs fins	81-88, 151-152, 241
Ecarteurs fins double	81, 152

Ecarteurs mammaires	205
Ecarteurs mandibulaires	98
Ecarteurs mucoperiostales	119
Ecarteurs nasaux	81, 164-166
Ecarteurs pour la crête iliaque	97
Ecarteurs pour les ailes du nez	162-164
Ecarteurs pour parties molles	95
Elévateur mammaire	204
Elévateur pour fractures de la cloison nasale	176
Elévateur pour fractures nasales	175
Elévateurs	104, 175-177, 245, 252
Elévateurs aspirantes	176
Elévateurs pour la cloison nasale	177
Embouts de couteaux	264
Embouts des canules	208
EMMET Ecarteur fin	86
Endoscopes	248, 263
ENTNER Aiguilles à ligature	246
ENTNER Canules pour liposuccion	212-214
EPKER CASTROVIEJO Compas	128
ERICH Arcs en fil	137
EWALD HUDSON Pinces anatomiques	45
EWALD HUDSON Pinces chirurgicale	45
F	
FANOUS Ciseaux à tunnellation	31
FANOUS Ciseaux pour dissection	31
FANOUS Ciseaux pour rhinoplastie	145
FANOUS Ostéotomes	190
FANOUS-GUBISCH Ostéotome	190
FARABEUF Ecarteur	90
FARABEUF-BABY Ecarteur	90
Fil d'acier pour la fixation avec aiguilles	252
Fils	137
Fils à os	137
FINSEN Ecarteurs autostatiques	99
Fixe-menton	98
FOMON Ciseaux pour rhinoplastie	144-145
FOMON Crochet	241
FOMON Ecarteur pour les ailes du nez	163
FOMON GUBISCH HM Râpe nasale	161
FOMON Ostéotomes	191
FOMON Râpe nasale	158
FOX Ciseaux pour gencive	36
FOX Pinces à saisir les tissus	48-49, 56-57
Fraises	196
FRAMER Conducteurs de tendons	260
FRAZIER Ecarteur fin	84
FREEMAN GORNEY Ciseaux pour dissection	33



FREEMAN METZENBAUM	
Ciseaux pour dissection	28
FREER Couteau à muqueuse	178
FREER Ecarteur fin	151
FREER Elévateurs	175
FREER Gouges pour la cloison nasale	184
FREER OBWEGESER Rugines	110
FREER Rugine	179
FUNKE Plaque pour la fixation de la main	266

G

GILLIES Ecarteurs fins	85
GILLIES HM Porte-aiguille	66
GILLIES Pince chirurgicale	48
GILLIES Porte-aiguille	66
GILLIES-SLIM HM Porte-aiguille	66
GILLIES-SLIM Porte-aiguille	66
GIUNTA Ciseaux pour rhinoplastie	146
GOLDMAN Elévateur pour fractures de la cloison nasale	176
Goniomètre	125
Goniomètre pour doigts de mains	125
GORNEY Ciseaux pour dissection	32
GORNEY Ciseaux pour rhinoplastie	148
GORNEY-FREEMAN	
Ciseaux pour dissection	33
Gouges	184
Gouges pour la cloison nasale	184
GRAEFE ADSON Pince chirurgicale	47
Grattoirs à cartilages	156
GREEN LANGENBECK Ecarteurs fins	83, 241
GREEN SENN Ecarteurs fins	82
GREENBERG PAR	
Ciseaux délicats pour dissection	14
GROSS Pince à pansements	200
GRUENWALD Pince en forme bayonnette	149
GUBISCH AIACH Pince	196
GUBISCH-AUFRICHT Ecarteurs nasaux	165
GUBISCH COTTLE Ciseaux burins	185
GUBISCH DANIEL Rugines	105-107
GUBISCH FANOUS Ostéotome	190
GUBISCH-FOMON HM Râpe nasale	161
GUBISCH HM Porte-aiguille	150
GUBISCH-KILNER Crochet pour ailes du nez	162
GUBISCH Ostéotomes	188
GUBISCH Pince blépharoplastie	242
GUBISCH Porte-plume	126, 198
GUBISCH	
Presse pour matière cartilagineuse	194
GUBISCH-RUBIN HM Pince pour aplatissement de la cloison nasale	197
GUBISCH Rugines aspirantes	182

Guide	199
Guide pour endoscopes	248, 263
GUILLEN Maillet	183
GUTHRIE Ecarteurs fins	152

H

HALLE TIECK Spéculums nasaux	153
HALSEY HM Porte-aiguille	61
HALSEY Porte-aiguille	61
HALSTED MICRO Pince hémostatiques	74
HALSTED-MOSQUITO Pincés hémostatiques	76
HANNA Spatule à langue	122
HARALDSSON Elévateur aspirateur	176
HARGIS Rugine	108
HARTMANN Pincés à pansements pour le nez	167
HARTMANN Spéculums nasaux	153
HEERMANN Manche	264
HEGAR MAYO HM Porte-aiguilles	62
HEGAR MAYO Porte-aiguilles	63
HEYMANN Ciseaux pour rhinoplastie	142
HEYMANN Pincés pour la cloison nasale	168
HINDERER Pince à saisir le cartilage	149
HM Pince	26-27
HM Porte-aiguilles	60-61, 63-69, 150
HOEFERT DENHART Ouvre-bouche	122
HOSPITAL PROVIDENCE	
Pincés hémostatiques	75
HOUGH Ciseaux pour rhinoplastie	147
HUDSON-EWALD Pince anatomique	45
HUDSON-EWALD Pince chirurgicale	45
Huiles d'entretien des instruments	274
HUMBY Dermatome	139
HUMBY Ecarteur fin	85

I

Instruments à cartilage	116-117, 194-197
Instruments à marquer	125-129, 199
Instruments à mesurer	125-129, 199
Instruments à os	116-117, 196-197
Instruments pour fils métalliques	136
Instruments pour fissures palatines	118-120
Instruments pour lèvres	118-120
IRIS Ciseaux délicats	9-11
IRIS MICRO Ciseaux délicates	11

J

JABALEY Ciseaux délicats	8
JACKSON Crochet trachéaux	87
JACKSON Ecarteur fin	81
JACOBSON HM Micro porte-aiguilles	69
JACOBSON MICRO 2000 Micro ciseaux	39



JACOBSON MICRO Pincés hémostatiques	74
JACOBSON Micro porte-aiguilles	69
JAMESON Ciseaux délicats pour dissection	17
JAMESON Pied à coulisse	125
JAMESON REYNOLDS Ciseaux pour dissection	30
JANSEN Curette	107
JOSEPH Ciseaux délicats pour dissection	15
JOSEPH Ciseaux pour rhinoplastie	147
JOSEPH Couteau à cartilages de la cloison nasale	174
JOSEPH Couteaux pour rhinoplastie	174
JOSEPH-DANIEL Ciseaux pour dissection	29
JOSEPH Ecarteurs fins	151-152
JOSEPH Guide	199
JOSEPH-MASING Rugine pour cloison nasale	107
JOSEPH PECK Ciseaux délicats pour dissection	15
JOSEPH Scies nasales	171
K	
KAHRE Rugine pour fissure palatine	118
KASTEN Choriote	138
KAYE Ciseaux pour dissection	31, 35
KELLY BRÜSER Ciseaux délicats à dissection	18
KELLY Ciseaux à fil	44
KELLY Ciseaux pour dissection	29
KILLIAN Gouge pour la cloison nasale	184
KILLIAN Spéculum nasaux	154
KILLIAN-CLAUS Gouge pour la cloison nasale	184
KILNER Crochet pour ailes du nez	162
KILNER GUBISCH Crochet pour ailes du nez	162
KILNER RAGNELL Ciseaux délicats pour dissection	14
KISTLER Limes pour le cartilage de l'anthélix	253-254
KLEINERT-KUTZ Ecarteurs fins	86
KLEINERT-KUTZ Pincés conductrices pour tendons	258
KNAPP Ciseaux délicats pour dissection	12-13
KOCHER Ecarteurs	91
KOSHIMA CASTROVIEJO Micro porte-aiguilles	68
KOSHIMA Micro ciseaux	37
KOSHIMA MICRO JACOBSON Pincés hémostatiques	75
KOTZUR Canule pour liposuction	217
KRETSCHMER Pivot de référence	129
KUTZ KLEINERT Ecarteurs fins	86
KUTZ KLEINERT Pincés conductrices pour tendons	258
L	
LAHEY-CLINIC Ecarteur fin	84

Lame de rechange pour choriote	138
Lames de bistouris	2-4
Lames de rechange pour dermatomes	139-140
Lames de scie	130-133
LANDOLT Manches pour bistouris	4
LANGENBECK Couteaux pour rhinoplastie	174
LANGENBECK Ecarteurs	91
LANGENBECK Elévateur	175
LANGENBECK (US ARMY) PARKER Ecarteurs	89
LANGENBECK-GREEN Ecarteurs fins	83, 241
LEMPERT Rugines	105
LERICHE Pincés hémostatiques	76
Levier à os	191
LEWIS HM Râpe nasale	158
LEWIS Râpe nasale	157
LEXER Ciseaux pour dissection	20
LEXER MAYO Ciseaux pour dissection	20
LEXER-BABY Ciseaux délicats pour dissection	12
Limes nasales	161
Limes pour le cartilage de l'anthélix	253-254
LINDEMANN Fraise	196
LITTAUER Ciseaux à fil	44
LITTLER Ciseaux guide-fil	143
LUBET-BARBON Pince à pansements pour le nez	167
LUC-BRÜNINGS (HEYMANN) Pincés pour cloison nasale	168
M	
MAGGY Tapis pour instruments, magnétique	273
Maillets	183
MALTZ Râpe nasale	156
Manche	264
Manches à doser le lipofilling	229
Manches pour bistouris	2-4
Manches pour canules	222, 233
Marqueur pour facelift	127
Marqueurs du bout du nez	199
Marqueurs pour l'aréole	204
MARX Ecarteurs mammaires	205
MASING COTTLE Ciseaux pour rhinoplastie	143
MASING COTTLE Porte-aiguilles pour suture de la muqueuse	67
MASING Ecarteur pour les ailes du nez	163
MASING Elévateur pour la cloison nasale	177
MASING JOSEPH Rugine pour cloison nasale	107
MASING Lime nasale	161
MASING Râpe nasale	161
MATHIEU HM Porte-aiguilles	67
MAYO Ciseaux pour dissection	19



N04

Alphabetischer Index
 Alphabetical Index
 Índice alfabético
 Index alphabétique
 Índice alfabético

MAYO-HEGAR HM Porte-aiguilles	63
MAYO-HEGAR Porte-aiguilles	62
MAYO-LEXER Ciseaux pour dissection	20
MAYO-STILLE Ciseaux pour dissection	21
McINDOE Ciseaux à cartilages	144
McINDOE Ciseaux burins	187
McINDOE Pince anatomique	48
McINDOE Rugine pour fissure palatine	118
McKENTY COTTLE Rugine	181
McKENTY Rugines	179
McKESSON Baïllons	124
Medicontainer	268-269
MERCEDES Canules pour liposuccion	217
MERSHON Positionneur de fil	136
METZENBAUM BABY Ciseaux délicats pour dissection	17, 18
METZENBAUM Ciseaux pour dissection	22-23, 28
METZENBAUM-FREEMAN Ciseaux pour dissection	28
METZENBAUM MINI Ciseaux délicats pour dissection	18
METZENBAUM NELSON Ciseaux pour dissection	24-25
METZENBAUM-SLIM Ciseaux pour dissection	26-27
MEYERDING Ecarteurs fins	82
MICRO 2000 JACOBSON Micro ciseaux	39
MICRO 2000 (KOSHIMA) Micro pince	51
MICRO 2000 Micro ciseaux	37-40
MICRO 2000 Micro pinces	50-52
MICRO 2000 Micro porte-aiguilles	69-70
MICRO 2000 Pinces à suture	54
Micro ciseaux	37-41
Micro clips vasculaires	77-80
Micro pinces	50-53
Micro porte-aiguilles	68-72
Micro scie à guichet	133
Micro scie oscillante	130
Micro scie sagittale	131
Micro scies	130-135
MICRO-ADSON Pinces anatomiques	47
MICRO-ADSON Pinces chirurgicales	47
MICRO CASTROVIEJO Porte-aiguilles	68
MICRO-HALSTED Pinces hémostatiques	74
MICRO-IRIS Ciseaux délicats	11
MICRO-JACOBSON Pinces hémostatiques	74
MICRO-JACOBSON (KOSHIMA) Pinces hémostatiques	75
MILLARD (COTTLE) Ecarteurs pour les ailes du nez	163
MILLER SENN Ecarteurs fins	81
MINI-METZENBAUM Ciseaux délicats pour dissection	18

MOBERG Ciseaux burins	187
Mobilisateur pour maxillaire	115
MOD. LANZ Poinçon	256
MOD. LANZ Davier à os	257
MOD. LANZ Décollecteurs de tendons	261
MOD. LANZ Ecarteur fin	83
MOD. WIEN Spéculums nasaux	153
MOLT Ouvre-bouches	122
MÖLTGEN Goniomètre	125
MOSQUITO AT Pinzes hémostatiques	74
MOSQUITO HALSTED Pinces hémostatiques	76
Moulin à os	117
Moyen anti-embuant pour endoscopes	274

N

NAGATA Couteaux à modeler	250
NAGATA Elévateurs	104, 252
NAGATA HM Porte-aiguilles	60
NEIVERT COTTLE Ecarteur pour les ailes du nez	163
NEIVERT Ecarteur pour les ailes du nez	163
NEIVERT HM Porte-aiguille	60
NEIVERT Porte-aiguille	59
NELSON Pinces à saisir les tissus	55
NELSON-METZENBAUM Ciseaux pour dissection	24-25
NEWS Crochet trachéaux	87
NIRO HM Pince serre-fil	250

O

O'BRIEN Ciseaux à fil	44
OBWEGESER Articulateur pour chirurgie sur modèle	128
OBWEGESER Ciseaux pour dos nasal	148
OBWEGESER Ecarteur d'épine nasale	96
OBWEGESER Ecarteur pour dent de sagesse	96
OBWEGESER Ecarteur pour le bord du maxillaire inférieur	93
OBWEGESER Ecarteurs à rameau	94
OBWEGESER Ecarteurs mandibulaires	98
OBWEGESER Ecarteurs pour la crête iliaque	97
OBWEGESER Ecarteurs pour parties molles	95
OBWEGESER Fixe-menton	98
OBWEGESER-FREER Rugines	110
OBWEGESER HM Pince pour œillets en fil métallique	136
OBWEGESER Mobilisateur pour maxillaire	115
OBWEGESER Ostéotome pterygoïde	111
OBWEGESER Ostéotomes	111-113
OBWEGESER Ostéotomes à fendre	112
OBWEGESER Ostéotomes cunéiformes	112



OBWEGESER Ostéotomes en lame	113
OBWEGESER Ostéotomes interdentaires	111
OBWEGESER	
Ostéotomes pour la cloison nasale	193
OBWEGESER Pince à torsader le fil	136
OBWEGESER Pincettes plieuse pour os	116
OBWEGESER Pincettes pour la cloison nasale	173
OBWEGESER Râpes nasales	159
OBWEGESER Rugines	108-109
OBWEGESER Rugines costales	106
Optiques	248, 263
Osséocalpel	132
Ostéotome pterygoïde	111
Ostéotomes	111-115, 186-193
Ostéotomes à fendre	112, 191
Ostéotomes cunéiformes	112
Ostéotomes cylindriques	114
Ostéotomes en lame	113
Ostéotomes interdentaires	111
Ostéotomes orbitaux	115
Ostéotomes pour la cloison nasale	193
Ouvre-bouches	122-123
P	
PARKER-LANGENBECK (US ARMY)	
Ecarteurs	89
PEAN Pince hémostatique	74
PECK-JOSEPH Ciseaux délicats pour dissection	15
PENNINGTON Elévateur	104
Pieds à coulisse	125
Pince à champ	200
Pince à saisir les paupières	56
Pince à saisir les tissus	56
Pince à torsader le fil	136
Pince blépharoplastie	242
Pince en forme bayonnette	149
Pince pour columelle	155
Pince pour œillets en fil métallique	136
Pince à préhension pour tendons	257
Pince presse	196-197
Pince presse-cartilage	196
Pince serre-fil	250
Pincettes à appliquer	77-80
Pincettes à pansements	200
Pincettes à pansements pour le nez	167
Pincettes à préhension les tendons	257
Pincettes à saisir	247
Pincettes à saisir les tissus	55-57, 149
Pincettes à suture	54
Pincettes à vomer	168
Pincettes anatomiques	45-46, 48-49
Pincettes chirurgicales	45-49

Pincettes conductrices pour tendons	258
Pincettes délicates	45-48
Pincettes-gouges	257
Pincettes hémostatiques	73-76
Pincettes HM	31, 35
Pincettes micro	50-53
Pincettes nasales	169-170
Pincettes plieuse pour os	116
Pincettes pour aplatissement de la cloison nasale	197
Pincettes pour entrelacer les tendons	259
Pincettes pour la cloison nasale	168, 172-173
Pincettes pour le redressement de la cloison nasale	172-173
Pincettes pour os ethmoïdal	170
Pincettes pour saisir le cartilage	57, 149
Pincettes titane	53
PITANGUY Marqueur pour facelift	127
Pivot de référence	129
Pivots de dilatation	265
Plaque pour la fixation de la main	266
Plaque pour tendre la peau	140
Plateau de préparation	138
Plume pour le repérage	126
Poinçons	152, 256
Pompe d'infiltration pour la liposuction	234
Porte-aiguilles	58-72, 150
Porte-aiguilles avec ciseaux	66
Porte-aiguilles HM	60-61, 63-69, 150
Porte-aiguilles HM explications	58
Porte-aiguilles micro	68-72
Porte-aiguilles pour suture de la muqueuse	67
Porte-aiguilles titane	72
Porte-plume	126, 198
Positionneur à fil	136
Positionneur du nombril	237
Presses pour matière cartilagineuse	194
PROVIDENCE-HOSPITAL	
Pincettes hémostatiques	75
R	
RAGNELL (KILNER)	
Ciseaux délicats à dissection	14
RAGNELL Ecarteur fin	81
Râpe	133
Râpes nasales	156-161
Règles	125
Releveurs à paupières	93
REYNOLDS (JAMESON)	
Ciseaux pour dissection	30
RUBIN GUBISCH HM Pince pour aplatissement de la cloison nasale	197



RUBIN HM Pince pour aplatissement de la cloison nasale	197
RUBIN Ostéotomes	186, 191
RUBIN Pincés pour aplatissement de la cloison nasale	197
Rugine à tunnellation	181
Rugine pour cloison nasale	107
Rugine pour le fond orbital	110
Rugines	105-110, 179-182, 244
Rugines aspirantes	182
Rugines costales	106, 251
Rugines pour fissures palatines	118, 120
RUSS. MOD. Pince à saisir les tissus	55

S

SACHSE Micro scie oscillante	131
SACHSE Micro scie sagittale	130
SACHSE Osséocalpel	132
SALDANHA-SOLZ Ecarteur abdominal	236
SCHINK Dermatome	140
SCHROM Ostéotomes	190
Scies micro	130-135
Scies nasales	171
SEMKEN Pincés anatomiques	48
SEMKEN Pincés chirurgicales	48
SENN-GREEN Ecarteurs fins	82
SENN-MILLER Ecarteurs fins	81
SENNING HM Porte-aiguille	65
SENNING Porte-aiguille	65
Seringe à cylindre en verre	226, 228
Seringues	210, 226, 228, 230, 233
Seringues en matière plastique	210, 226, 230, 233
Seringues pour l'infiltration	210
Seringues vacuum à cylindre en verre	226, 228
SHEA Ciseaux délicats pour dissection	14
SHEPARD Ostéotomes cylindriques	114
SIEGERT Ciseaux à tunnellation	15
SILVER Dermatome	140
SILVER Ostéotomes	192
SLIM Ciseaux délicats pour dissection	16
SLIM GILLIES HM Porte-aiguille	66
SLIM GILLIES Porte-aiguille	66
SLIM METZENBAUM Ciseaux pour dissection	26-27
SOLZ Ciseaux pour dissection	34
SOLZ Dissecteurs crochet	203
SOLZ Dissecteurs mammaire atraumatique	202
SOLZ Marqueurs pour l'aréole	204
SOLZ Positionneur du nombril	237
SOLZ SALDHANA Ecarteur abdominal	236

Spatules à langue	122, 200
Spéculum pour la cloison nasale	155
Spéculums nasaux	153-155
SPENCER Ciseaux à fils	43
Spray huileux	274
STEINHÄUSER Osteotomes orbitaux	115
STEINHÄUSER Rugine pour le fond orbitale	110
STEINMANN Pince à préhension pour tendons	257
STELLBRINK Pincés-gouges	257
STERNBERG Ecarteur de joue	121
STEVENS Ciseaux délicats	8, 11
STEVENS Ciseaux délicats pour dissection	13, 17
STILLE MAYO Ciseaux à dissection	21
STILLE STRANDELL Ecarteurs fins	83, 241
Stoppeur pour seringues	226
STRAIGHT Ecarteur fin	84
STRANDELL-STILLE Ecarteurs fins	83, 241
Stylet	256
SULSENTI WINTER HM Porte-aiguille	150
Support pour seringues	228

T

Tapis pour instruments, magnétique	273
TEBBETTS Ecarteurs	92
TESSIER Ostéotomes	113
TESSIER Rugines	110
THOMSON-WALKER (BOZEMANN) Porte-aiguille	65
THORPE Pied à coulisse	125
TIECK-HALLE Spéculums nasaux	153
Titane micro porte-aiguilles	72
Titane pincés	53
Titane porte-aiguilles	72
TOENNIS-ADSON Ciseaux pour dissection	27
TOLEDO Canule pour le prélèvement de graisse autologue	224
TOLEDO Canules pour liposuction	216
Trocart	114
TROELTSCH (WILDE) Pince à saisir les tissus	56
TSCHOEPE Pince presse-cartilages	196

U

UNIV. MINNESOTA CAWOOD Ecarteur de joue	121
UNIVERSAL HM Ciseaux coupe-fil	251
UNIVERSAL WALSHAM Pincés pour le redressement de la cloison nasale	172
US ARMY Ecarteurs	89

V

VON GREGORY Canules pour le prélèvement de graisse autologue	224-225
VON GREGORY Canule pour l'infiltration	210



W	
WALKER THOMSON (BOZEMANN) Porte-aiguille	65
WALSHAM Pincés pour le redressement de la cloison nasale	172
WALSHAM UNIVERSAL Pince pour le redressement de la cloison nasale	172
WALTER AUFRICHT Ecarteurs nasaux	166
WALTER Ciseaux burins	186
WALTER Ciseaux pour rhinoplastie	145
WALTER COPE Ecarteur nasale	81
WALTER Ecarteur	89
WALTER Ecarteur avec illumination à lumière froide	166
WALTER Ostéotomes	187
WALTER Pince à saisir paupières	56
WALTER-COTTLE Ciseaux pour rhinoplastie	146
WANG Ouvre-bouche	123
WANG Rugines	120
WATSON Dermatome	139
WAUGH Pincés anatomiques	49
WAUGH Pincés chirurgicales	49
WEIL-BLAKESLEY Pincés nasales	169-170
WEIL-BLAKESLEY Pincés pour os ethmoïdal	170
WEITLANER Ecarteurs autostatiques	100-101
WERTHEIM BOZEMANN HM Porte-aiguilles	65
WESTMACOTT Pincés à pansements pour le nez	167
WIENER MOD. Spéculums nasaux	153
WILDE TROELTSCH Pince à saisir les tissus	56
WILLIGER Curette	107
WILLIGER Rugines	179
WINTER Ciseaux pour rhinoplastie	147
WINTER COTTLE Pince à saisir les tissus	149
WOOD CRILE HM Porte-aiguilles	64
WOOD CRILE Porte-aiguilles	64
WRIGHT (DERF) HM Porte-aiguille	61
WRIGHT (DERF) Porte-aiguille	61
Y	
YANKAUER Elévateur pour la cloison nasale	177



N05

Alphabetischer Index
 Alphabetical Index
 Índice alfabético
 Index alphabétique
 Índice alfabético

A	
Abbassalingua	123
Approssimatori	79
Micro clip vascolari	77, 79
Pinze per applicare per micro clip	77, 79
Adattatore	210, 226, 229
Adattatore di trasferimento	229
ADSON-BROWN Pinze chirurgiche	47
ADSON Divaricatori delicati	85
ADSON-GRAEFE Pinza chirurgica	47
ADSON HM Pinze anatomiche	45
ADSON HM Pinze chirurgiche	46
ADSON MICRO Pinze anatomiche	47
ADSON MICRO Pinze chirurgiche	47
ADSON Pinza anatomica	45
ADSON Pinze chirurgiche	46
ADSON TOENNIS Forbici per dissezione	27
Aghi per legatura	246
AIACH Pinza	196
AIACH-GUBISCH Pinze	196
ALAMUTI Pinza per afferrare tessuti	149
ALM Divaricatori autostatici	100
Approssimatori	78-80
Apribocca	122-124
Archi di filo	137
Articolatore per chirurgia modello	128
ASCH Pinza per rizzare il setto nasale	173
Attacchi cannule	208
AUFRIEHT-DANIEL Divaricatore nasale	165
AUFRIEHT Divaricatori nasali	164-165
AUFRIEHT Forbici per rinoplastica	144
AUFRIEHT GUBISCH Divaricatori nasali	165
AUFRIEHT Raspe nasali	158
AUFRIEHT-WALTER Divaricatori nasali	166
B	
BABY FARABEUF Divaricatore	90
BABY LEXER Forbici delicate per dissezione	12
BABY-METZENBAUM Forbici delicate per dissezione	17, 18
BACKHAUS Pinza fissatele	200
BALLENGER Sgorbie per il setto nasale	184
BARBON LUBET Pinza per tamponamento nasale	167
BARRAQUER Micro portaghi	68
BARSKY Divaricatori delicati	86
BENICKE Divaricatori delicati	87
BERGMANN Divaricatore delicate	86
BIEMER Approssimatori	78, 80
BIEMER Micro clip vascolari	78
BIEMER Pinze per applicare	78

BIG RING BABY-METZENBAUM Forbici delicate per dissezione	17
BIG RING Forbici per iridectomia	11
BIG RING METZENBAUM BABY Forbici delicate per dissezione	17
BIG RING STEVENS Forbici delicate per dissezione	17
Bisturi	2-4
BLAKE Manico per bisturi	2
BLAKESLEY Pinze nasali	169
BLAKESLEY WEIL Pinze nasali	169-170
BLAKESLEY WEIL Pinze per osso etmoidale	170
Bloccaggio della siringa	226
Blocchi per tagliare cartilagine	195
BLOCKSMA Uncini per fessura del palato	118
BLUME Osteotomo	192
BOIES Elevatore per fratture nasali	175
BOZEMANN THOMSON-WALKER Portaghi	65
BOZEMANN (WERTHEIM) HM Portaghi	65
BRAND Eucleatori per tendini	261
BRAND Pinza passa tendini	258
BROWN ADSON Pinze chirurgiche	47
BRÜNINGS LUC (HEYMANN) Pinze per il setto nasale	168
C	
ÇAKIR Osteotomo	189
ÇAKIR DANIEL Periostotomi	180
Calibri micrometrici	125
Calibro	199
Cannule per infiltrazione	210
Cannule per iniezione	210, 230
Cannule per iniezione del grasso autologo	223
Cannule per l'asportazione del grasso	224-225
Cannule per liposuzione	212-221
CAPLAN Forbice per setto nasale	146
Cassette per endoscopi	272
Cassette per strumenti delicati	270-271
CASTROVIEJO Compassi	127, 199, 242
CASTROVIEJO HM MICRO Portaghi per mucosa	68
CASTROVIEJO-EPKER Compassi	128
CASTROVIEJO (KOSHIMA) Micro portaghi	68
CASTROVIEJO-MICRO Portaghi	68



CAWOOD UNIV. MINNESOTA	
Divaricatore di guance	121
CINELLI Forbice per rinoplastica	143
CINELLI Osteotomi	192
CLAUDINHA Spatola per lingua	122
CLAUS KILLIAN Sgorbia per il setto nasale	184
CLINIC LAHEY Divaricatore delicate	84
Clip vascolari	77-80
COHEN Elevatore	104
COLLIER Portaghi	59
Coltelli	264
Coltelli per modellare	250
Coltelli per rinoplastica	174
Coltello per cartilagine del setto nasale	174
Coltello per mucosa	178
Compassi	127-128, 199, 242
Compasso per ossa	127
Contenitori per sterilizzazione	268-269
CONVERSE Coltello per rinoplastica	174
CONVERSE-DANIEL Forbice per dissezione	142
CONVERSE DERF Portaghi	62
CONVERSE Divaricatori per alette nasali	162
CONVERSE Forbice per rinoplastica	143
CONVERSE HM Portaghi	60
CONVERSE Lima nasale	161
CONVERSE Periostotomo	107
CONVERSE Portaghi	59
COPE Divaricatore delicate	81
COPE-WALTER Divaricatore nasale	81
Coppa per colore di marcatura	204
Coriotomo	138
COTTLE Coltelli per rinoplastica	174
COTTLE-DANIEL Periostotomo	180
COTTLE Divaricatore delicate	87
COTTLE Divaricatori per alette nasali	162-164
COTTLE Elevatore	175
COTTLE Elevatore per ossa e osteotome fenditore	191
COTTLE Elevatori per il setto nasale	177
COTTLE Forbice Bulldog	143
COTTLE Forbice per setto nasale	148
COTTLE Forbici per rinoplastica	143, 145, 147-148
COTTLE-GUBISCH Scalpelli	185
COTTLE HM Raspa nasale	157
COTTLE Martello	183
COTTLE-MASING Forbici per rinoplastica	143
COTTLE-MASING Portaghi per mucosa	67
COTTLE-McKENTY Periostotomo	181
COTTLE MILLARD Divaricatore per alette nasali	163
COTTLE-NEIVERT Divaricatore per alette nasali	163
COTTLE Osteotomi	186-189
COTTLE Periostotomi	107, 181

COTTLE Periostotomo scollatore	183
COTTLE Pinza per afferrare tessuto	149
COTTLE Pinza per columella	155
COTTLE Raspa nasale	157
COTTLE Scalpelli	185
COTTLE Specoli nasali	154-155
COTTLE Specolo per il setto nasale	155
COTTLE Trita cartilagine	194
COTTLE WALTER Forbici per rinoplastica	146
COTTLE-WINTER Pinza per afferrare tessuto	149
CRAIG-DOMNICK Pinze per vomere	168
CRAIG Pinza per vomere	168
CRILE Divaricatori delicati	85, 152
CRILE-WOOD HM Portaghi	64
CRILE-WOOD Portaghi	64
Cucchiai	107
Curetta per aspirazione per l'ascella	232

D

DANIEL AUFRICHT Divaricatore nasale	165
DANIEL-ÇAKIR Periostotomi	180
DANIEL CONVERSE Forbice per dissezione	142
DANIEL COTTLE Periostotomo	180
DANIEL Forbice per dissezione	29
DANIEL-GUBISCH Periostotomi	105-107
DANIEL JOSEPH Forbici per dissezione	29
DANIEL Punteruolo	152
DAUTREY Arco di filo	137
DEAN Forbici per gengiva	36
DEBAKEY AT Pinza per afferrare tessuto	55
DEBAKEY HM Portaghi	64
DENHART Apribocca	122
DENHART-HOEFERT Apribocca	122
DERF-CONVERSE Portaghi	62
DERF WRIGHT HM Portaghi	61
DERF WRIGHT Portaghi	61
Dermatomi	139-140
DESMARRES Elevatori per palpebre	93, 241
DIETHRICH Pinze Bulldog	73
DINGMAN Apribocca	123
DINGMAN Periostotomo	109
DINGMAN Raschiatori per cartilagine	156
Dissetore V	232
Dissettori	244-245
Dissettori a uncino	203
Dissettori mammari	202-203
Dissettori mammario atraumatico	202
Divaricatore addominale	236
Divaricatore con canale per endoscopio	248
Divaricatore per de dita	256
Divaricatore per dente del giudizio	96
Divaricatore per il bordo della mascella inferiore	93



N05

Alphabetischer Index
 Alphabetical Index
 Índice alfabético
 Index alphabétique
 Índice alfabético

Divaricatori	81-98
Divaricatori autostatici	99-101
Divaricatori con illuminazione a luce fredda	92, 166
Divaricatori delicati	81-88, 151-152, 241
Divaricatori di guance	121
Divaricatori di labbra	121
Divaricatori mammari	205
Divaricatori mandibolari	98
Divaricatori mucoperiostali	119
Divaricatori nasali	81, 164-166
Divaricatori per alette nasali	162-164
Divaricatori per la cresta iliaca	97
Divaricatori per ramo	94
Divaricatori per tessuti molli	95
Divaricatori delicati doppi	81, 152
DOMNICK CRAIG Pinze per vomere	168
DOROW Curetta per aspirazione per l'ascella	232
DOROW Dissetore V	232
DOYEN Periostotomi per le costole	251

E

Elevatore mammario	204
Elevatore per fratture nasali	175
Elevatore per ossa	191
Elevatori	104, 175-177, 245, 252
Elevatori aspiranti	176
Elevatore per fratture del setto nasale	176
Elevatori per il setto nasale	177
Elevatori per palpebre	93
EMMET Divaricatore delicate	86
Endoscopi	248, 263
ENTNER Aghi per legatura	246
ENTNER Cannule per liposuzione	212-214
Enucleatore per tendini	261
EPKER CASTROVIEJO Compassi	128
ERICH Archi di filo	137
EWALD HUDSON Pinza anatomica	45
EWALD HUDSON Pinza chirurgica	45

F

FANOUS Forbici per dissezione	31
FANOUS Forbici per rinoplastica	145
FANOUS Forbici per tunnelizzare	31
FANOUS-GUBISCH Osteotomo	190
FANOUS Osteotomi	190
FARABEUF-BABY Divaricatore	90
FARABEUF Divaricatore	90
Fili	137
Fili per ossa	137
Filo di fissaggio con aghi	252

FINSSEN Divaricatori autostatici	99
FOMON Divaricatore per alette nasali	163
FOMON Forbici per rinoplastica	144-145
FOMON GUBISCH HM Raspa nasale	161
FOMON Osteotomi	191
FOMON Raspa nasale	158
FOMON Uncino	241
Forbice Bulldog	143
Forbice chirurgice	43
Forbice guida filo	143
Forbice per cartilagine	144
Forbice per fili d'acciaio	251
Forbici	5-44
Forbici ad uncino	247
Forbici delicate	8-11
Forbici delicate per dissezione	12-18
Forbici micro	37-41
Forbici per blefaroplastica	31
Forbici per dissezione	12-35
Forbici per dorso nasale	148
Forbici per gengiva	36
Forbici per iridectomia	9-11
Forbici per legature	42
Forbici per rinoplastica	142-148
Forbici per setto nasale	146, 148
Forbici per tunnelizzare	15, 31
Forbici spiegazioni	6
Forbici taglia-fili	43-44
FOX Forbici per gengiva	36
FOX Pinze per afferrare tessuti	48-49, 56-57
FRAMER Guidatendini	260
FRAZIER Divaricatore delicate	84
FREEMAN GORNEY Forbici per dissezione	33
FREEMAN METZENBAUM Forbici per dissezione	28
FREER Coltello per mucosa	178
FREER Divaricatore delicate	151
FREER Elevatori	175
FREER OBWEGESER Periostotomi	110
FREER Periostotomo	179
FREER Sgorbie per il setto nasale	184
Frese	196
FUNKE Piastra per fissaggio della mano	266

G

Gancio per mento	98
GILLIES Divaricatori delicati	85
GILLIES HM Portaghi	66
GILLIES Pinza chirurgica	48
GILLIES Portaghi	66
GILLIES-SLIM HM Portaghi	66
GILLIES-SLIM Portaghi	66



GIUNTA Forbici per rinoplastica	146
GOLDMAN Elevatore per fratture del setto nasale	176
Goniometro	125
Goniometro per le dita	125
GORNEY Forbice per rinoplastica	148
GORNEY Forbici per dissezione	32
GORNEY-FREEMAN Forbici per dissezione	33
GRAEFE ADSON Pinza chirurgica	47
GREEN LANGENBECK Divaricatori delicati	83, 241
GREEN SENN Divaricatori delicati	82
GREENBERG PAR Forbici delicate per dissezione	14
GROSS Pinza per medicazione	200
GRUENWALD Pinza a forma di baionetta	149
GUBISCH AIACH Pinze	196
GUBISCH COTTLE Scalpelli	185
GUBISCH DANIEL Periostotomi	105-107
GUBISCH FANOUS Osteotomo	190
GUBISCH FOMON HM Raspa nasale	161
GUBISCH HM Portaghi	150
GUBISCH Osteotomi	188
GUBISCH Periostotomi aspiranti	182
GUBISCH Pinza blefaroplastica	242
GUBISCH Porta-piuma	126, 198
GUBISCH-RUBIN HM Pinza per appiattimento del setto nasale	197
GUBISCH Trita cartilagine	194
GUBISCH-AUFRICHT Divaricatori nasali	165
GUBISCH-KILNER Divaricatore per alette nasali	162
Guida per endoscopi	248, 263
Guidatendini	259
GUILLEN Martello	183
GUTHRIE Divaricatori delicati	152
H	
HALLE TIECK Specoli nasali	153
HALSEY HM Portaghi	61
HALSEY Portaghi	61
HALSTED MICRO Pinze emostatiche	74
HALSTED-MOSQUITO Pinze emostatiche	76
HANNA Spatola per lingua	122
HARALDSSON Elevatore aspirante	176
HARGIS Periostotomo	108
HARTMANN Pinze per tamponamento nasale	167
HARTMANN Specoli nasali	153
HEERMANN Manico	264
HEGAR MAYO HM Portaghi	63
HEGAR MAYO Portaghi	62
HEYMANN Forbici per rinoplastica	142
HEYMANN Pinze pour il setto nasale	168

HINDERER Pinza per afferrare cartilagine	149
HM Pinze	26-27
HM Portaghi	60-61, 63-69, 150
HOEFERT DENHART Apribocca	122
HOSPITAL PROVIDENCE Pinze emostatiche	75
HOUGH Forbice per rinoplastica	147
HUDSON-EWALD Pinza anatomica	45
HUDSON-EWALD Pinza chirurgica	45
HUMBY Dermatomo	139
HUMBY Divaricatore delicate	85
I	
Inseri per coltelli	264
IRIS Forbici delicate	9-11
IRIS MICRO Forbici delicate	11
J	
JABALEY Forbici delicate	8
JACKSON Divaricatore delicate	81
JACKSON Uncino tracheale	87
JACOBSON HM Micro portaghi	69
JACOBSON Micro portaghi	69
JACOBSON MICRO 2000 Micro forbici	39
JACOBSON MICRO Pinze emostatiche	74
JAMESON Calibro micrometrico	125
JAMESON Forbici delicate per dissezione	17
JAMESON REYNOLDS Forbici per dissezione	30
JANSEN Cucchiaino	107
JOSEPH Calibro	199
JOSEPH Coltelli per rinoplastica	174
JOSEPH Coltello per cartilagine del setto nasale	174
JOSEPH-DANIEL Forbici per dissezione	29
JOSEPH Divaricatori delicati	151-152
JOSEPH Forbice per rinoplastica	147
JOSEPH Forbici delicate per dissezione	15
JOSEPH-MASING Periostotomo per setto nasale	107
JOSEPH PECK Forbici delicate per dissezione	15
JOSEPH Seghe nasali	171
K	
KAHRE Periostotomo per fessura del palato	118
KASTEN Coriotomo	138
KAYE Forbici per dissezione	31, 35
KELLY BRÜSER Forbici delicate per dissezione	18
KELLY Forbice taglia-fili	44
KELLY Forbici per dissezione	29
KILLIAN-CLAUS Sgorbia per il setto nasale	184
KILLIAN Sgorbia per il setto nasale	184
KILLIAN Specoli nasali	154
KILNER Divaricatore per alette nasali	162
KILNER GUBISCH Divaricatore per alette nasali	162



KILNER RAGNELL	
Forbici delicate per dissezione	14
KISTLER Lime per cartilagine del anthelix	253, 254
KLEINERT-KUTZ Divaricatori delicati	86
KLEINERT-KUTZ Pinza passa tendini	258
KNAPP Forbici delicate per dissezione	12-13
KOCHER Divaricatori	91
KOSHIMA CASTROVIEJO Micro portaghi	68
KOSHIMA Micro forbici	37
KOSHIMA MICRO JACOBSON	
Pinze emostatiche	75
KOTZUR Cannula per liposuzione	217
KRETSCHMER Perno di referenza	129
KUTZ KLEINERT Divaricatori delicati	86
KUTZ KLEINERT Pinza passa tendini	258
L	
LAHEY-CLINIC Divaricatore delicate	84
Lama di ricambio per coriotomo	138
Lame da sega	130-133
Lame di ricambio per dermatomi	139-140
Lame per bisturi	2-4
LANDOLDT Manici per bisturi	4
LANGENBECK Coltelli per rinoplastica	174
LANGENBECK Divaricatori	91
LANGENBECK Elevatore	175
LANGENBECK-GREEN Divaricatori delicati	83, 241
LANGENBECK PARKER (US ARMY)	
Divaricatori	89
Lastra di preparazione	138
LEMPERT Periostotomi	105
LERICHE Pinze emostatiche	76
LEWIS HM Raspa nasale	158
LEWIS Raspa nasale	157
LEXER Forbici per dissezione	20
LEXER MAYO Forbici per dissezione	20
LEXER-BABY Forbici delicate per dissezione	12
Lime nasali	161
Lime per cartilagine del anthelix	253, 254
LINDEMANN Fresa	196
Liquido antiempano per endoscopi	274
LITTAUER Forbice taglia-fili	44
LITTLER Forbice guida filo	143
LUBET-BARBON	
Pinza per tamponamento nasale	167
LUC-BRÜNINGS (HEYMANN)	
Pinze per il setto nasale	168
M	
MAGGY Tappetino per strumenti, magnetico	273
MALTZ Raspa nasale	156
Manici per bisturi	2-4

Manici per cannule	222, 233
Manici per dosare il lipofilling	229
Manico	264
Marcatore per facelift	126
Marcatori della punta del naso	199
Marcatori per areola	204
Martelli	183
MARX Divaricatori mammari	205
MASING COTTLE Forbici per rinoplastica	143
MASING COTTLE Portaghi per mucosa	67
MASING Divaricatore per alette nasali	163
MASING Elevatore per il setto nasale	177
MASING JOSEPH	
Periostotomo per setto nasale	107
MASING Lima nasale	161
MASING Raspa nasale	161
MATHIEU HM Portaghi	67
MAYO Forbici per dissezione	19
MAYO HEGAR HM Portaghi	63
MAYO HEGAR Portaghi	62
MAYO-LEXER Forbici per dissezione	20
MAYO-STILLE Forbici per dissezione	21
McINDOE Forbice per cartilagine	144
McINDOE Periostotomo per fessura del palato	118
McINDOE Pinza anatomica	48
McINDOE Scalpelli	187
McKENTY COTTLE Periostotomo	181
McKENTY Periostotomi	179
McKESSON Apribocca	124
Medicontainer	268-269
MERCEDES Cannule per liposuzione	217
MERSHON Posizionatore per filo	136
METZENBAUM BABY	
Forbici delicate per dissezione	17, 18
METZENBAUM-FREEMAN	
Forbici per dissezione	28
METZENBAUM Forbici per dissezione	22-23, 28
METZENBAUM MINI	
Forbici delicate per dissezione	18
METZENBAUM NELSON	
Forbici per dissezione	24-25
METZENBAUM-SLIM Forbici per dissezione	26-27
MEYERDING Divaricatori delicati	82
MICRO 2000 JACOBSON Micro forbici	39
MICRO 2000 (KOSHIMA) Micro pinza	51
MICRO 2000 Micro forbici	37-40
MICRO 2000 Micro pinze	50-52
MICRO 2000 Micro portaghi	69-70
MICRO 2000 Pinze per sutura	54
Micro clip vascolari	77-80
Micro forbici	37-41
Micro pinze	50-53



Micro portaghi	68-72
Micro sega	133
Micro sega oscillante	130
Micro sega sagittale	131
Micro seghe	130-135
MICRO-ADSON Pinze anatomiche	47
MICRO-ADSON Pinze chirurgiche	47
MICRO CASTROVIEJO Portaghi	68
MICRO-HALSTED Pinze emostatiche	74
MICRO-IRIS Forbici delicate	11
MICRO-JACOBSON (KOSHIMA) Pinze emostatiche	75
MICRO-JACOBSON Pinze emostatiche	74
MILLARD (COTTLE) Divaricatore per alette nasali	163
MILLER SENN Divaricatori delicati	81
MINI-METZENBAUM Forbici delicate per dissezione	18
MOBERG Scalpelli	187
Mobilizzatore per mascella	115
MOD. LANZ Eucleatori per tendini	261
MOD. LANZ Tenaglia per ossa	257
MOD. LANZ Puntaruolo	256
MOD. WIEN Specoli nasali	153
MOD. LANZ Divaricatore delicate	83
MOLT Apribocca	122
MÖLTGEN Goniometro	125
MOSQUITO AT Pinze emostatiche	74
MOSQUITO HALSTED Pinze emostatiche	76

N

NAGATA Coltelli per modellare	250
NAGATA Elevatori	104, 252
NAGATA HM Portaghi	60
NEIVERT COTTLE Divaricatore per alette nasali	163
NEIVERT Divaricatore per alette nasali	163
NEIVERT HM Portaghi	60
NEIVERT Portaghi	59
NELSON-METZENBAUM Forbici per dissezione	24-25
NELSON Pinze per afferrare tessuti	55
NEWS Uncino tracheale	87
NIRO HM Pinza tendifili d'acciaio	250

O

O'BRIEN Forbice taglia-fili	44
OBWEGESER Articolatore per chirurgia modello	128
OBWEGESER Divaricatore per dente del giudizio	96
OBWEGESER Divaricatore per il bordo della mascella inferiore	93
OBWEGESER Divaricatori mandibolari	98

OBWEGESER Divaricatori per la cresta iliaca	97
OBWEGESER Divaricatori per ramo	94
OBWEGESER Divaricatori per tessuti molli	95
OBWEGESER Forbici per dorso nasale	148
OBWEGESER-FREER Periostotomi	110
OBWEGESER Gancio per mento	98
OBWEGESER HM Pinza per occhiello in filo metallico	136
OBWEGESER Mobilizzatore per mascella	115
OBWEGESER Osteotomi	111-113
OBWEGESER Osteotomi a forma di cueno	112
OBWEGESER Osteotomi a forma di lama	113
OBWEGESER Osteotomi fenditori	112
OBWEGESER Osteotomi interdentali	111
OBWEGESER Osteotomi per il setto nasale	193
OBWEGESER Osteotomo per tubercolo	111
OBWEGESER Periostotomi	108-109
OBWEGESER Periostotomi per le costole	106
OBWEGESER Pinza per torcere fili	136
OBWEGESER Pinze per il setto nasale	173
OBWEGESER Pinze per piegare ossa	116
OBWEGESER Raspe nasali	159
OBWEGESER Separatore per spina nasale	96
Olio per strumenti	274
Osseoscalpello	132
Osteotomi	111-115, 186-193
Osteotomi a forma di cueno	112
Osteotomi a forma di lama	113
Osteotomi cilindrici	114
Osteotomi interdentali	111
Osteotomi orbitali	115
Osteotomi per fendere osso	112, 191
Osteotomi per il setto nasale	193
Osteotomo per tubercolo	111
Ottiche	248, 263

P

PARKER-LANGENBECK (US ARMY) Divaricatori	89
PEAN Pinza emostatica	74
PECK-JOSEPH Forbici delicate per dissezione	15
PENNINGTON Elevatore	104
Periostotomi	105-110, 179-182, 244
Periostotomi aspiranti	182
Periostotomi per fessure del palato	118, 120
Periostotomi per le costole	106, 251
Periostotomo per il pavimento orbitale	110
Periostotomo per il setto nasale	107
Periostotomo scollatore	181
Perni di dilatazione	265



N05

Alphabetischer Index
 Alphabetical Index
 Índice alfabético
 Index alphabétique
 Indice alfabético

Perno di referenza	129
Piastra per il fissaggio della mano	266
Piastra per tendere la pelle	140
Pinza a forma di baionetta	149
Pinza blepharoplastica	242
Pinza da presa per falangi	257
Pinza per afferare tendini	257
Pinza fissatele	200
Pinza passa tendini	258
Pinza per afferrare palpebre	56
Pinza per columella	155
Pinza per intrecciare tendini	259
Pinza per occhio in filo metallico	136
Pinza per torcere fili	136
Pinza tendifili d'acciaio	250
Pinza trita cartilagine	196
Pinze anatomiche	45-46, 48-49
Pinze Bulldog	73
Pinze chirurgiche	45-49
Pinze delicate	45-48
Pinze emostatiche	73-76
Pinze HM	31, 35
Pinze micro	50-53
Pinze nasali	169-170
Pinze per afferrare	247
Pinze per afferrare cartilagine	57, 149
Pinza per afferrare tessuti	55-57, 149
Pinze per appiattimento del setto nasale	197
Pinze per applicare	77-80
Pinze per il setto nasale	168, 172-173
Pinze per medicazione	200
Pinze per osso etmoidale	170
Pinze per piegare ossa	116
Pinze per rizzare il setto nasale	172-173
Pinze per sutura	54
Pinze per tamponamento nasale	167
Pinze per vomere	168
Pinze sgorbie	257
Pinze titanio	53
PITANGUY Marcatore per facelift	127
Piuma per marcare	126
Plastra per tendere la pelle	140
Pompa d'infiltrazione per la liposuzione	234
Porta-piuma	126, 198
Portaghi	58-72, 150
Portaghi con forbici	66
Portaghi HM	60-61, 63-69, 150
Portaghi HM spiegazioni	58
Portaghi micro	68-72
Portaghi per mucosa	67
Posizionatore dell'ombelico	237
Posizionatore per filo	136

PROVIDENCE-HOSPITAL	
Pinze emostatiche	75
Punteruoli	152, 256
R	
RAGNELL (KILNER)	
Forbici delicate per dissezione	14
RAGNELL Divaricatore delicate	81
Raschiatori per cartilagine	156
Raspa in carburo di tungsteno	133
Raspe nasali	156-161
REYNOLDS (JAMESON) Forbici per dissezione	30
Righe	125
RUBIN HM Pinza per appiattimento del setto nasale	197
RUBIN Osteotomi	186, 191
RUBIN Pinze per appiattimento del setto nasale	197
RUBIN GUBISCH HM Pinza per appiattimento del setto nasale	197
RUSS. MOD. Pinza per afferrare tessuto	55
S	
SACHSE Micro sega oscillante	130
SACHSE Micro sega sagittale	131
SACHSE Osseoscalpello	132
SALDANHA-SOLZ Divaricatore addominale	236
Scalpelli	185-187
SCHINK Dermatomo	140
SCHROM Osteotomi	190
Scodella	204
Seghe micro	130-135
Seghe nasali	171
SEMKEN Pinze anatomiche	48
SEMKEN Pinze chirurgiche	48
SENN-GREEN Divaricatori delicati	82
SENN-MILLER Divaricatori delicati	81
SENNING HM Portaghi	65
SENNING Portaghi	65
Separatore per spina nasale	96
Sgorbie	184-186
Sgorbie per il setto nasale	184
SHEA Forbici delicate per dissezione	14
SHEPARD Osteotomi cilindrici	114
SIEGERT Forbici per tunnelizzare	15
SILVER Dermatomo	140
SILVER Osteotomi	192
Siringa in sotto vuoto	226, 228
Siringhe	210, 226, 228, 230, 233
Siringhe in materia plastica	210, 226, 230, 233
Siringhe in vetro sotto vuoto	226, 228



Siringhe per infiltrazione	210
SLIM Forbici delicate per dissezione	16
SLIM GILLIES HM Portaghi	66
SLIM GILLIES Portaghi	66
SLIM METZENBAUM Forbici per dissezione	26-27
SOLZ Dissettori a uncino	203
SOLZ Dissettori mammario atraumatico	202
SOLZ Forbici per dissezione	34
SOLZ Marcatori per areola	204
SOLZ Posizionatore dell'ombelico	237
SOLZ SALDANHA Divaricatore addominale	236
Sonda	256
Spatole per lingua	122, 200
Specoli nasali	153-155
Specolo per il setto nasale	155
SPENCER Forbici taglia-fili	43
Spray d'olio	274
STEINHÄUSER Osteotomi orbitali	115
STEINHÄUSER	
Periostotomo per il pavimento orbitale	110
STEINMANN Pinza per afferrare tendini	257
STELLBRINK Pinze sgorbie	257
STERNBERG Divaricatore di guance	121
STEVENS Forbici delicate	8, 11
STEVENS Forbici delicate per dissezione	13, 17
STILLE MAYO Forbici per dissezione	21
STILLE STRANDELL Divaricatori delicati	83, 241
STRAIGHT Divaricatore delicate	84
STRANDELL-STILLE	
Divaricatori delicati	83, 241
Strumenti per cartilagine	116-117, 194-197
Strumenti per fessure del palato	118-120
Strumenti per fili d'acciaio	136
Strumenti per labbra	118-120
Strumenti per marcare	125-129, 199
Strumenti per misurare	125-129, 199
Strumenti per ossa	116-117, 196-197
SULSENTI WINTER HM Portaghi	150
Supporto per siringhe	228
T	
Tappetino per strumenti, magnetico	273
TEBBETTS Divaricatori	92
Tenaglia per ossa	257
TESSIER Osteotomi	113
TESSIER Periostotomi	110
THOMSON-WALKER (BOZEMANN) Portaghi	65
THORPE Calibro micrometrico	125
TIECK-HALLE Specoli nasali	153
Titanio micro portaghi	72
Titanio pinze	53
Titanio portaghi	72

TOENNIS-ADSON Forbici per dissezione	27
TOLEDO	
Cannula per l'asportazione del grasso	224
TOLEDO Cannule per liposuzione	216
Trita cartilagine	194
Trita ossa	117
Trocar	114
TROELTSCH (WILDE)	
Pinza per afferrare tessuto	56
TSCHOEPE Pinza tritacartilagine	196
U	
Uncini per duramadre	84
Uncini per fessura del palato	118
Uncini per nervi	246
Uncini per pelle	84, 86, 162
Uncini tracheali	87
Uncino fistolare	86
UNIV. MINNESOTA CAWOOD	
Divaricatore di guance	121
UNIVERSAL HM Forbice per fili d'acciaio	251
UNIVERSAL WALSHAM	
Pinza per rizzare il setto nasal	172
US ARMY Divaricatori	89
V	
VON GREGORY Cannule per l'asportazione del grasso	210, 224-225
VON GREGORY Cannula per infiltrazione	210
W	
WALKER THOMSON (BOZEMANN) Portaghi	65
WALSHAM Pinze per rizzare il setto nasale	172
WALSHAM UNIVERSAL	
Pinza per rizzare il setto nasale	172
WALTER AUFRICHT Divaricatori nasali	166
WALTER COPE Divaricatore nasale	81
WALTER-COTTLE Forbici per rinoplastica	146
WALTER Divaricatore	89
WALTER Divaricatore con illuminazione a luce fredda	166
WALTER Forbice per rinoplastica	145
WALTER Osteotomi	187
WALTER Pinza per afferrare palpebre	56
WALTER Scalpelli	186
WANG Apribocca	123
WANG Periostotomi	120
WATSON Dermatomo	139
WAUGH Pinze anatomiche	49
WAUGH Pinze chirurgiche	48
WEIL-BLAKESLEY Pinze nasali	169-170



WEIL-BLAKESLEY Pinze per osso etmoidale	170
WEITLANER Divaricatori autostatici	100, 101
WERTHEIM BOZEMANN HM Portaghi	65
WESTMACOTT	
Pinze per tamponamento nasale	167
WIENER MOD. Specoli nasali	153
WILDE TROELTSCH Pinza per afferare tessuto	56
WILLIGER Cucchiaio	107
WILLIGER Periostotomi	179
WINTER COTTLE Pinza per afferare tessuto	149
WINTER Forbice per rinoplastica	147
WOOD CRILE HM Portaghi	64
WOOD CRILE Portaghi	64
WRIGHT (DERF) HM Portaghi	61
WRIGHT (DERF) Portaghi	61

Y

YANKAUER Elevatore per il setto nasale	177
--	-----

MEDICONTAINER CONTAINER System



**N06**

Numerischer Index
Numerical Index
Indice numérico
Index numérique
Indice numerico

01.22.10	2	02.21.61	10	04.13.68	14	04.35.73	26
01.22.11	2	02.22.61	10	04.24.14	16	04.36.68	28
01.22.12	2	02.23.61	10	04.24.18	16	04.36.70	28
01.22.15	3	02.27.12	9	04.24.20	16	04.36.73	28
01.22.21	3	02.40.10	12	04.24.64	16	04.50.15	15
01.22.23	3	02.40.11	13	04.25.14	16	04.51.15	15
01.22.32	3	02.40.12	13	04.25.18	16	04.54.16	29
01.22.35	3	02.40.60	12	04.25.20	16	04.54.66	29
01.27.03	2	02.40.61	13	04.25.64	16	04.55.16	29
01.27.07	2	02.40.62	13	04.32.11	18	04.55.66	29
01.27.13	3	02.41.10	12	04.32.14	22	04.63.18	27
01.27.17	2	02.41.11	13	04.32.18	22	04.63.68	27
01.27.21	4	02.41.12	13	04.32.20	22	04.66.12	30
01.27.23	2	02.41.60	12	04.32.23	24	04.66.14	30
01.27.25	4	02.41.61	13	04.32.26	24	04.66.16	30
01.27.40	2	02.41.62	13	04.32.30	24	04.66.18	30
01.27.45	3	02.44.10	12	04.32.61	18	04.67.12	30
01.27.63	3	02.45.10	12	04.32.64	22	04.67.13	13
01.27.93	3	02.45.30	14	04.32.68	22	04.67.14	30
01.28.14	3	02.50.12	11	04.32.70	22	04.67.16	30
01.30.32	4	02.50.13	11	04.32.73	24	04.67.18	30
01.30.36	4	02.50.22	8	04.33.11	18	04.73.67	32
01.30.38	2	02.50.23	8	04.33.14	23	04.73.69	32
01.30.62	4	02.50.32	8	04.33.15	23	04.73.73	32
01.30.64	4	02.50.33	8	04.33.18	23	04.75.67	33
01.30.65	4	03.06.13	43	04.33.20	23	04.75.69	33
01.30.67	4	03.50.14	19	04.33.23	25	04.75.72	33
01.94.19	140	03.50.17	19	04.33.26	25	04.75.73	33
01.97.01	250	03.50.64	19	04.33.30	25	04.77.67	35
01.97.02	250	03.50.67	19	04.33.61	18	04.77.69	35
01.97.04	250	03.51.14	19	04.33.63	22	04.77.73	35
01.97.05	250	03.51.17	19	04.33.64	23	04.80.13	36
01.97.06	250	03.51.64	19	04.33.68	23	04.80.63	36
02.06.10	8	03.51.67	19	04.33.70	23	04.81.13	36
02.06.13	8	03.56.86	20	04.33.73	25	04.81.63	36
02.07.10	8	03.56.96	20	04.33.76	25	05.12.20	37
02.07.13	8	03.57.15	21	04.33.80	25	05.12.21	37
02.20.09	9	03.57.17	21	04.34.14	26	05.12.32	37
02.20.10	9	03.57.65	21	04.34.18	26	05.12.34	37
02.20.11	9	03.57.67	21	04.34.20	26	05.15.20	37
02.20.12	9	03.57.86	20	04.34.23	26	05.15.21	37
02.20.30	11	03.57.96	20	04.34.64	26	05.15.22	38
02.20.42	12	03.57.97	20	04.34.68	26	05.15.23	38
02.20.43	12	04.10.61	15	04.34.70	26	05.15.30	38
02.20.61	9	04.11.61	15	04.34.73	26	05.15.31	38
02.21.09	10	04.13.12	14	04.35.14	26	05.15.70	40
02.21.10	10	04.13.13	14	04.35.18	26	05.15.71	40
02.21.11	10	04.13.15	14	04.35.20	26	05.15.72	40
02.21.12	10	04.13.18	14	04.35.23	26	05.15.73	40
02.21.30	11	04.13.20	14	04.35.64	26	05.15.74	38
02.21.42	12	04.13.63	14	04.35.68	26	05.15.75	38
02.21.43	12	04.13.65	14	04.35.70	26	05.15.76	38



**Numerischer Index
Numerical Index
Indice numérico
Index numérique
Indice numerico**

05.15.77	38	06.31.25	48	09.87.01	218	09.87.63	214
05.15.81	40	06.31.32	48	09.87.02	218	09.87.64	212
05.15.83	40	06.40.15	48	09.87.03	218	09.87.65	212
05.16.68	41	06.40.85	48	09.87.04	218	09.87.66	212
05.16.69	41	06.42.15	49	09.87.07	219	09.87.67	213
05.16.74	41	06.42.20	49	09.87.08	219	09.87.68	213
05.16.75	41	06.43.15	49	09.87.09	219	09.87.69	213
05.18.20	39	06.43.20	49	09.87.10	219	09.87.70	212
05.18.21	39	06.45.20	49	09.87.11	219	09.87.71	212
05.18.25	39	06.50.15	55	09.87.12	219	09.87.72	212
05.18.26	39	07.15.15	55	09.87.14	218	09.87.73	214
05.18.68	41	07.19.15	55	09.87.15	218	09.87.74	212
05.18.69	41	07.19.23	55	09.87.16	218	09.87.75	212
05.18.70	40	07.30.16	149	09.87.17	218	09.87.76	212
05.18.71	40	07.35.13	56	09.87.19	218	09.87.77	213
05.18.72	40	07.61.05	50	09.87.20	216	09.87.78	213
05.18.73	40	07.61.06	50	09.87.21	216	09.87.79	213
05.18.74	41	07.61.07	50	09.87.22	216	09.87.80	228
05.18.75	41	07.61.08	50	09.87.23	216	09.87.81	213
05.18.81	40	07.61.11	50	09.87.24	216	09.87.82	215, 226, 228
05.18.83	40	07.61.12	50	09.87.25	216	09.87.85	210, 226
05.19.02	39	07.61.13	50	09.87.26	216	09.87.86	228
05.21.68	41	07.61.14	50	09.87.27	216	09.87.87	213
05.21.69	41	07.61.25	51	09.87.28	216	09.87.88	214
05.21.74	41	07.61.26	51	09.87.29	216	09.87.89	214
05.21.75	41	07.61.27	51	09.87.31	210	09.87.90	229
06.07.14	45	07.61.28	51	09.87.32	210	09.87.92	230
06.20.01	45	07.63.30	51	09.87.33	219	09.87.93	229
06.20.05	45	07.63.31	51	09.87.34	219	09.87.94	230
06.20.12	45	07.64.63	52	09.87.37	220	09.87.95	229
06.20.62	45	07.64.64	52	09.87.38	220	09.87.98	230
06.20.65	45	07.64.73	52	09.87.40	220	09.88.01	230
06.21.12	46	07.64.74	52	09.87.41	220	09.88.02	230
06.21.13	46	07.64.83	52	09.87.43	210, 226, 233	09.88.03	230
06.21.15	46	07.64.84	52	09.87.44	226	09.88.04	230
06.21.62	46	07.64.93	52	09.87.45	222	09.88.05	210
06.21.65	46	07.64.94	52	09.87.46	222	09.88.06	210
06.22.12	47	07.74.15	53	09.87.47	221	09.88.30	217
06.22.15	47	07.74.18	53	09.87.48	221	09.88.31	217
06.23.12	47	07.74.21	53	09.87.49	221	09.88.32	217
06.23.15	47	07.75.15	53	09.87.50	221	09.88.33	217
06.25.12	47	07.75.18	53	09.87.51	221	09.88.34	217
06.25.15	47	07.75.21	53	09.87.52	221	09.88.45	222
06.25.72	47	07.76.15	53	09.87.53	221	09.88.46	215, 222, 233
06.25.82	47	07.76.18	53	09.87.54	221	09.88.83	229
06.30.12	48	07.76.21	53	09.87.55	221	09.89.05	232
06.30.15	48	07.77.15	53	09.87.57	221	09.89.10	232
06.30.22	48	07.77.18	53	09.87.58	221	09.89.15	223
06.30.25	48	07.77.21	53	09.87.59	221	09.89.16	223
06.31.12	48	09.78.44	228	09.87.60	212	09.89.17	223
06.31.15	48	09.78.47	226, 228	09.87.61	212	09.89.18	223
06.31.22	48	09.87.00	218	09.87.62	212	09.89.22	224

**N06**

Numerischer Index
Numerical Index
Indice numérico
Index numérique
Indice numerico

09.89.24	224	10.59.14	66	12.16.75	72	13.71.50	54
09.89.26	225	10.59.15	66	12.16.76	72	13.71.51	54
09.89.28	210, 225	10.59.64	66	12.16.77	72	13.71.52	54
10.04.13	59	10.59.65	66	12.16.78	72	13.71.53	54
10.08.12	59	11.20.64	67	12.18.56	71	13.71.58	54
10.08.15	59	11.20.67	67	12.18.57	71	13.71.59	54
10.08.62	60	11.20.70	67	12.18.60	71	13.71.60	54
10.08.65	60	11.20.74	67	12.18.61	71	13.71.61	54
10.09.61	60	11.62.64	68	12.18.66	71	13.71.62	54
10.09.63	60	11.62.67	68	12.18.67	71	13.71.63	54
10.12.12	61	11.62.84	68	12.18.68	71	13.71.70	54
10.12.13	61	11.62.87	68	12.18.69	71	13.71.71	54
10.12.61	150	11.70.22	68	12.18.70	70	13.71.72	54
10.12.62	61	11.70.23	68	12.18.71	70	13.71.73	54
10.12.63	61	11.70.24	68	12.18.72	70	13.71.82	54
10.12.82	62	11.70.25	68	12.18.73	70	13.71.83	54
10.18.15	62	11.70.26	68	12.18.74	70	13.71.84	54
10.18.18	62	11.70.27	68	12.18.75	70	14.06.09	43
10.18.20	62	11.70.28	68	12.18.76	71	14.06.10	43
10.18.23	62	11.70.29	68	12.18.77	71	14.06.12	43
10.18.24	62	11.74.13	68	12.18.78	71	14.06.13	44
10.18.65	63	11.74.15	68	12.18.79	71	14.06.15	44
10.18.68	63	11.74.23	68	12.18.80	71	14.06.60	43
10.18.70	63	11.74.25	68	12.18.81	71	14.06.62	43
10.18.73	63	11.82.18	69	12.18.82	71	14.06.84	42
10.18.74	63	11.82.21	69	12.18.83	71	14.06.88	42
10.18.76	63	11.82.68	69	12.18.85	72	14.06.93	42
10.18.80	63	11.82.71	69	12.18.86	72	14.07.09	44
10.18.85	63	11.84.68	69	12.18.87	72	14.23.62	251
10.18.88	63	11.85.68	69	12.18.88	72	14.40.65	250
10.18.90	63	11.86.68	69	12.21.56	71	14.70.10	252
10.18.93	63	11.87.68	69	12.21.57	71	15.10.08	73
10.20.15	64	12.12.40	69	12.21.60	71	15.10.12	73
10.20.18	64	12.12.41	69	12.21.61	71	15.10.16	73
10.20.20	64	12.12.54	71	12.21.66	71	15.11.08	73
10.20.23	64	12.12.55	71	12.21.67	71	15.11.12	73
10.20.65	64	12.12.56	71	12.21.70	71	15.11.16	73
10.20.68	64	12.12.57	71	12.21.71	71	15.40.12	74
10.20.70	64	12.12.59	71	12.21.76	71	15.40.82	74
10.20.73	64	12.12.61	71	12.21.77	71	15.40.84	75
10.20.75	64	12.15.56	71	12.21.78	71	15.41.12	74
10.20.80	64	12.15.57	71	12.21.79	71	15.41.82	74
10.37.20	65	12.15.66	71	12.21.80	71	15.41.84	75
10.37.70	65	12.15.67	71	12.21.81	71	15.42.12	74
10.37.74	65	12.15.70	70	12.21.82	71	15.43.12	74
10.37.76	65	12.15.71	70	12.21.83	71	15.44.10	75
10.37.80	65	12.15.72	70	12.21.95	72	15.44.12	76
10.39.17	65	12.15.73	70	12.21.96	72	15.44.22	75
10.39.64	65	12.15.76	71	12.21.97	72	15.44.32	76
10.39.65	65	12.15.77	71	12.21.98	72	15.44.42	74
10.39.66	65	12.15.78	71	13.71.42	54	15.45.10	75
10.39.67	65	12.15.79	71	13.71.43	54	15.45.12	76



Numerischer Index
Numerical Index
Indice numérico
Index numérique
Indice numerico

15.45.22	75	20.31.15	84	24.03.02	99	26.42.24	179
15.45.32	76	20.35.01	86	24.03.03	99	26.42.25	179
15.45.42	74	20.35.02	86	24.03.04	99	26.44.22	105
15.46.12	76	20.35.32	85	24.03.52	99	26.44.23	105
15.46.32	76	20.40.14	87	24.04.05	99	26.44.24	105
15.47.12	76	20.40.15	87	24.04.06	99	26.44.25	105
15.47.32	76	20.40.16	87	24.04.07	99	26.44.28	105
15.50.14	75	20.42.01	86	24.04.08	99	26.48.10	105
15.51.14	75	20.45.14	86	24.05.57	99	26.48.12	105
15.52.14	75	20.45.16	86	24.05.58	99	26.48.14	105
15.53.14	75	20.48.03	86	24.09.09	100	27.06.20	183
15.56.15	76	20.48.05	86	24.09.10	100	27.06.21	183
15.57.15	76	20.48.07	86	24.10.07	100	27.10.40	183
15.58.15	76	20.48.10	87	24.10.08	100	27.10.41	183
15.59.15	76	20.48.11	87	24.10.10	100	29.83.62	107
16.10.13	266	20.50.01	151	24.10.11	100	29.83.72	107
16.10.14	74	20.50.02	152	24.22.03	100	30.76.17	257
16.10.16	266	20.50.05	152	24.22.10	100	30.76.18	257
17.55.13	200	20.50.07	152	24.22.11	100	35.11.12	257
19.09.17	200	20.50.10	152	24.22.12	100	35.11.16	257
19.17.20	200	20.52.02	151	24.22.13	101	43.49.01	256
20.05.08	81	20.52.10	152	24.22.14	101	44.37.15	125
20.05.09	81	20.52.11	152	24.22.15	101	44.37.20	125, 129
20.05.25	81	20.60.01	88	24.22.16	101	44.37.30	125
20.05.50	81	20.60.02	88	24.22.17	101	44.37.50	125
20.05.55	81	20.60.03	88	24.22.18	101	44.38.10	125
20.07.08	81	20.60.04	88	24.90.00	204	44.38.30	125
20.09.30	152	20.61.01	88	24.90.10	202	44.38.40	127, 129
20.10.01	82	20.61.02	88	24.90.11	202	44.90.70	126, 198
20.10.02	82	20.61.03	88	24.90.15	203	44.90.72	126, 198
20.10.03	82	20.61.04	88	24.90.16	203	45.54.02	123
20.10.04	82	20.64.52	88	24.90.20	204	45.54.03	123
20.10.05	82	20.64.53	88	24.90.23	204	45.54.05	123
20.10.06	82	20.65.52	88	24.90.25	204	45.54.06	123
20.11.01	241	20.65.53	88	24.90.30	204	45.54.07	123
20.11.02	241	22.10.12	90	24.90.35	204	46.00.40	274
20.11.03	241	22.10.15	90	24.90.40	205	46.00.44	274
20.11.04	241	22.18.21	89	24.90.45	205	47.28.00	273
20.12.10	82	22.18.22	89	24.90.50	236	47.31.02	204
20.12.18	83	22.20.04	89	26.29.01	104, 252	49.50.10	269
20.12.20	82	23.06.10	91	26.29.02	104, 252	49.50.13	269
20.12.25	83	23.06.12	91	26.29.07	174	49.50.15	269
20.12.26	83	23.06.13	91	26.29.10	174	49.50.17	269
20.12.75	83	23.06.16	91	26.29.60	175	49.50.22	269
20.12.85	83	23.21.01	91	26.35.01	179	49.60.10	269
20.27.22	85	23.21.02	91	26.35.02	175	49.60.13	269
20.27.23	85	23.76.01	92	26.35.03	175	49.60.15	269
20.27.37	85	23.76.02	92	26.37.95	104	49.60.17	269
20.30.12	84	23.76.03	92	26.42.03	179	49.60.22	269
20.30.19	85	23.76.04	92	26.42.05	179	49.90.00	271
20.30.20	85	23.76.05	92	26.42.07	179	49.90.02	271
20.31.13	84	24.03.01	99	26.42.23	179	49.90.04	271

**N06**

Numerischer Index
Numerical Index
Indice numérico
Index numérique
Indice numerico

54.30.05	106	60.00.42	128	66.28.16	169	67.15.48	107
54.30.06	106	60.00.43	128	66.28.17	169	67.15.50	107
54.30.11	251	60.00.45	199	66.28.31	170	67.15.51	175
54.30.12	251	60.00.50	199	66.28.32	170	67.15.65	107
54.30.55	106	60.05.10	93	66.28.33	170	67.15.70	175
54.30.56	106	60.05.11	93	66.28.34	170	67.15.75	176
56.79.00	80	60.05.12	93	66.28.59	169	67.15.80	176
56.79.01	80	60.05.13	93	66.28.60	169	67.15.91	176
56.85.10	77	60.05.14	93	66.28.61	169	67.15.93	182
56.85.11	77	60.55.40	56	66.28.71	170	67.15.94	182
56.85.13	77	60.55.45	242	66.28.72	170	67.15.97	182
56.85.14	77	63.15.39	264	66.28.73	170	67.15.98	176
56.85.16	77	63.45.07	129	66.28.74	170	67.16.21	177
56.85.17	77	63.45.11	129	66.28.75	170	67.16.22	177
56.85.18	77	63.45.13	129	66.28.81	170	67.16.23	177
56.85.19	77	63.56.20	196	66.28.82	170	67.16.25	107
56.85.47	79	66.01.10	153	66.28.83	170	67.16.27	180
56.85.48	79	66.01.11	153	66.28.84	170	67.16.28	180
56.85.50	79	66.02.01	153	66.40.20	142	67.16.29	180
56.85.51	79	66.02.02	153	66.40.21	142	67.16.55	181
56.85.53	79	66.02.03	153	66.40.22	142	67.16.65	181
56.85.54	79	66.05.51	153	66.52.10	178	67.16.70	152
56.85.56	79	66.05.52	153	66.54.50	104	67.19.70	194
56.85.57	79	66.05.53	153	66.55.44	184	67.19.76	195
56.85.58	79	66.08.03	154	66.55.46	184	67.19.77	195
56.85.59	79	66.08.05	154	66.55.54	184	67.19.79	195
56.85.91	77, 79	66.08.07	154	66.55.56	184	67.19.80	194
56.85.93	77, 79	66.08.09	154	66.55.85	184	67.19.81	195
56.85.98	77, 79	66.08.59	154	66.55.90	184	67.20.03	162
56.87.05	78	66.20.10	167	67.02.35	154	67.20.05	162
56.87.08	78	66.20.11	167	67.02.55	154	67.20.07	162
56.87.18	78	66.20.25	167	67.02.75	154	67.20.10	162
56.87.35	78	66.20.27	167	67.02.90	154	67.20.11	162
56.87.45	78	66.20.28	167	67.03.50	155	67.20.21	162
56.87.46	78	66.25.11	168	67.03.52	155	67.20.22	162
56.87.49	80	66.25.12	168	67.10.20	174	67.20.23	163
59.45.15	53	66.25.15	168	67.10.30	174	67.20.25	163
59.45.18	53	66.25.16	168	67.10.35	174	67.20.44	163
59.45.21	53	66.25.17	168	67.10.40	174	67.20.50	163
59.46.15	53	66.28.01	170	67.10.42	174	67.20.51	163
59.46.18	53	66.28.02	170	67.10.60	174	67.20.52	163
59.46.21	53	66.28.03	170	67.14.15	138	67.21.15	164
59.47.15	53	66.28.04	170	67.14.20	138	67.21.25	164
59.47.18	53	66.28.05	170	67.14.25	138	67.21.30	166
59.47.21	53	66.28.06	169	67.14.30	139	67.21.32	165
59.48.15	53	66.28.07	169	67.14.31	139	67.21.33	165
59.48.18	53	66.28.08	169	67.14.35	139	67.21.35	165
59.48.21	53	66.28.11	170	67.14.50	140	67.21.38	164
60.00.30	125	66.28.12	170	67.14.51	140	67.21.39	164
60.00.31	125	66.28.13	170	67.14.52	140	67.21.40	166
60.00.40	127, 199, 242	66.28.14	170	67.15.30	180	67.21.45	166
60.00.41	127	66.28.15	169	67.15.35	177	67.21.46	165



**Numerischer Index
Numerical Index
Indice numérico
Index numérique
Indice numerico**

67.30.04	189	67.37.10	192	67.59.25	156	67.65.72	197
67.30.07	189	67.37.12	192	67.59.26	156	67.65.74	197
67.30.09	189	67.37.14	192	67.59.30	157	67.65.76	197
67.30.12	189	67.37.16	192	67.59.35	157	67.65.80	196
67.30.15	185	67.37.20	192	67.59.36	157	67.70.01	248
67.30.22	185	67.37.25	190	67.59.40	158	67.70.03	244
67.30.34	185	67.37.30	190	67.59.41	158	67.70.04	244
67.30.37	185	67.37.35	190	67.59.42	158	67.70.05	244
67.30.39	185	67.38.10	192	67.59.47	158	67.70.06	244
67.30.42	185	67.38.11	192	67.59.50	158	67.70.08	244
67.30.52	188	67.38.12	192	67.59.60	158	67.70.09	244
67.30.53	188	67.40.20	183	67.59.65	161	67.70.11	246
67.30.60	189	67.40.75	183	67.59.70	161	67.70.12	246
67.31.16	189	67.48.10	143	67.59.71	161	67.70.15	247
67.31.50	191	67.49.10	143	67.60.10	171	67.70.16	247
67.31.52	191	67.50.01	143	67.60.11	171	67.70.17	247
67.31.54	191	67.50.11	143	67.60.12	171	67.70.18	247
67.31.56	191	67.50.13	143	67.60.21	171	67.70.43	245
67.31.58	191	67.51.12	144	67.60.22	171	67.70.45	245
67.31.73	186	67.51.14	144	67.60.51	159	67.70.49	245
67.31.75	186	67.51.19	144	67.60.52	159	67.75.07	246
67.31.86	186	67.51.64	144	67.60.53	159	67.75.12	246
67.32.06	191	67.52.11	143	67.60.54	159	67.90.05	199
67.32.80	191	67.52.12	144	67.60.55	159	67.92.06	67
67.33.03	190	67.52.16	147	67.60.56	159	67.92.09	67
67.33.04	190	67.53.13	145	67.60.65	161	67.92.12	150
67.33.05	190	67.53.16	145	67.61.00	160	67.93.29	237
67.33.06	190	67.53.23	145	67.61.01	160	67.93.30	127
67.33.12	186	67.53.36	145	67.61.03	160	67.99.98	254
67.33.14	186	67.53.50	147	67.61.10	160	67.99.99	254
67.33.16	186	67.53.51	148	67.61.11	160	68.01.31	95
67.34.03	186	67.53.71	146	67.61.12	160	68.01.32	95
67.34.05	186	67.53.75	148	67.61.13	160	68.01.33	95
67.34.22	187	67.53.77	146	67.61.14	160	68.01.34	95
67.34.23	187	67.53.80	147	67.61.15	160	68.01.35	95
67.34.24	187	67.53.83	147	67.61.16	160	68.01.36	95
67.34.27	187	67.55.63	146	67.61.17	160	68.01.37	95
67.34.29	187	67.58.33	57	67.61.18	160	68.01.41	95
67.34.32	187	67.58.35	57	67.61.19	160	68.01.42	95
67.34.33	186	67.58.36	57	67.65.10	172	68.01.43	95
67.34.56	187	67.58.40	196	67.65.11	172	68.01.44	95
67.35.05	191	67.58.42	196	67.65.12	172	68.01.45	95
67.35.07	191	67.58.43	149	67.65.18	173	68.01.46	95
67.35.08	191	67.58.44	196	67.65.20	173	68.01.47	95
67.36.08	187	67.58.45	56	67.65.27	173	68.01.52	93
67.36.10	187	67.58.50	149	67.65.31	148	68.01.53	93
67.36.12	187	67.58.51	149	67.65.32	148	68.01.54	93
67.36.15	187	67.58.54	149	67.65.33	148	68.01.56	94
67.36.30	187	67.58.60	155	67.65.35	116	68.01.57	94
67.36.32	187	67.59.10	156	67.65.36	116	68.01.63	96
67.36.34	187	67.59.11	156	67.65.70	197	68.01.65	96
67.36.36	187	67.59.12	156	67.65.71	197	68.01.67	97

**N06**

Numerischer Index
Numerical Index
Indice numérico
Index numérique
Indice numerico

68.01.68	97	68.03.63	113	68.81.32	118	78.12.15	259
68.01.80	98	68.03.71	193	68.82.11	118	78.12.16	259
68.01.81	98	68.03.72	193	68.82.12	118	78.14.20	259
68.01.82	98	68.03.73	193	68.82.20	118	78.14.21	259
68.01.97	121	68.03.76	193	68.82.25	118	78.14.40	259
68.01.98	121	68.04.73	136	68.82.35	119	78.14.42	259
68.01.99	121	68.04.76	136	68.82.36	119	78.22.50	261
68.02.01	108	68.04.93	137	68.82.37	119	78.22.51	261
68.02.02	108	68.05.05	128	68.82.75	117	78.22.52	261
68.02.03	108	68.09.05	109	68.82.80	120	78.22.53	261
68.02.04	108	68.15.05	137	68.82.81	120	78.26.10	260
68.02.05	108	68.15.10	137	68.82.82	120	78.26.12	260
68.02.06	108	68.15.50	136	68.82.83	120	78.26.58	260
68.02.07	108	68.24.01	130, 134, 135	68.82.84	120	78.26.63	260
68.02.08	108	68.24.03	131, 134, 135	68.84.00	129	78.29.14	256
68.02.09	109	68.24.06	132, 134, 135	68.84.05	129	78.41.02	114
68.02.10	109	68.24.11	133, 134, 135	68.84.06	129	78.41.05	114
68.02.11	109	68.24.12	133	72.00.18	200	78.41.06	114
68.02.12	109	68.24.13	133	72.00.52	122	78.41.08	114
68.02.13	109	68.24.14	133	72.00.56	122	78.41.11	114
68.02.20	110	68.24.15	133	72.02.10	121	78.41.12	114
68.02.21	110	68.24.16	133	72.02.15	121	78.41.13	114
68.02.22	110	68.24.19	130, 131, 132, 133	72.05.10	122	78.41.14	114
68.02.31	109			72.05.15	122	78.41.15	114
68.02.32	109	68.24.20	130, 131, 132, 133	72.05.61	122	78.41.16	114
68.02.33	109			72.05.63	122	78.41.18	114
68.02.34	109	68.24.21	133	72.08.00	123	78.50.01	263
68.03.02	111	68.24.22	133	72.08.11	123	78.50.03	264
68.03.04	111	68.24.24	130	72.08.12	123	78.50.04	264
68.03.07P	112	68.24.25	130	72.08.13	123	78.50.06	264
68.03.10P	112	68.24.26	130	72.08.20	123	78.50.07	264
68.03.12P	112	68.24.27	130	72.10.01	124	78.50.08	264
68.03.13P	112	68.24.28	130	72.10.02	124	78.50.09	264
68.03.14P	112	68.24.29	130	72.10.03	124	78.50.11	265
68.03.16P	113	68.24.30	130	72.45.50	36	78.50.12	265
68.03.17P	113	68.24.31	130	76.01.03	137	78.50.13	265
68.03.18P	113	68.24.35	132	76.01.04	137	78.50.14	265
68.03.19P	113	68.24.36	132	76.01.05	137	91.10.10	274
68.03.29	115	68.24.37	132	77.60.00	248	91.10.11	274
68.03.30	111	68.24.70	131	77.60.03	248, 263	91.10.12	274
68.03.34	111	68.24.71	131	77.60.07	248	91.10.49	272
68.03.35	111	68.24.72	131	77.60.49	272	91.70.03	234
68.03.39	111	68.24.73	131	78.00.20	266	91.70.23	234
68.03.50	113	68.24.74	131	78.03.02	256	91.70.30	234
68.03.51	113	68.24.75	131	78.05.00	140	91.70.31	234
68.03.52	113	68.26.12	110	78.10.15	258	91.70.32	234
68.03.53	113	68.26.13	110	78.10.19	258	202.06.10	8
68.03.54	113	68.26.15	110	78.10.25	258	202.06.13	8
68.03.56	113	68.26.17	115	78.11.15	258	202.07.10	8
68.03.60	113	68.26.18	115	78.11.19	258	202.07.13	8
68.03.61	113	68.61.05	196	78.11.25	258	202.20.10	9
68.03.62	113	68.81.31	118	78.12.13	257	202.20.11	9



**Numerischer Index
Numerical Index
Indice numérico
Index numérique
Indice numerico**

202.20.42	12	204.16.15	15	204.35.64	26	205.15.20	37
202.20.61	9	204.17.15	15	204.35.68	26	205.15.21	37
202.21.10	10	204.24.14	16	204.35.70	26	205.15.74	38
202.21.11	10	204.24.64	16	204.35.73	26	205.18.70	40
202.21.12	10	204.25.14	16	204.36.18	28	205.18.71	40
202.21.30	11	204.25.18	16	204.36.20	28	212.06.10	8
202.21.42	12	204.25.64	16	204.36.23	28	212.06.13	8
202.21.61	10	204.32.09	18	204.36.68	28	212.07.10	8
202.22.11	10	204.32.11	18	204.36.70	28	212.07.13	8
202.22.61	10	204.32.14	22	204.36.73	28	212.20.10	9
202.23.11	10	204.32.18	22	204.37.18	28	212.20.11	9
202.23.61	10	204.32.20	22	204.37.20	28	212.21.10	10
202.40.11	13	204.32.23	24	204.37.23	28	212.21.11	10
202.40.12	13	204.32.26	24	204.50.15	15	212.22.11	10
202.40.61	13	204.32.30	24	204.51.15	15	212.23.11	10
202.40.62	13	204.32.61	18	204.54.16	29	212.26.11	11
202.41.11	13	204.32.64	22	204.54.66	29	212.27.11	11
202.41.12	13	204.32.68	22	204.55.16	29	212.40.11	13
202.41.61	13	204.32.70	22	204.55.66	29	212.40.12	13
202.41.62	13	204.32.73	24	204.56.16	18	212.41.11	13
202.50.12	11	204.33.09	18	204.57.16	18	212.41.12	13
202.50.13	11	204.33.11	18	204.63.18	27	212.50.12	11
203.50.14	19	204.33.13	22	204.63.68	27	212.50.13	11
203.50.17	19	204.33.14	23	204.67.12	30	213.50.14	19
203.50.64	19	204.33.15	23	204.67.13	13	213.50.17	19
203.50.67	19	204.33.18	23	204.67.16	30	213.51.14	19
203.51.14	19	204.33.20	23	204.67.17	17	213.51.17	19
203.51.17	19	204.33.23	25	204.67.18	30	213.56.86	20
203.51.64	19	204.33.26	25	204.68.16	31	213.57.15	21
203.51.67	19	204.33.30	25	204.68.18	17	213.57.17	21
203.56.86	20	204.33.61	18	204.68.20	31	213.57.47	20
203.56.96	20	204.33.63	22	204.69.16	31	213.57.86	20
203.57.15	21	204.33.64	23	204.69.20	31	214.13.12	14
203.57.17	21	204.33.68	23	204.73.17	32	214.13.13	14
203.57.47	20	204.33.70	23	204.73.19	32	214.13.15	14
203.57.65	21	204.33.73	25	204.73.23	32	214.13.18	14
203.57.67	21	204.33.76	25	204.75.17	33	214.14.15	15
203.57.86	20	204.33.80	25	204.75.19	33	214.15.15	15
203.57.96	20	204.34.14	26	204.75.22	33	214.16.15	15
203.57.97	20	204.34.18	26	204.75.23	33	214.17.15	15
204.10.11	15	204.34.20	26	204.77.12	31	214.32.09	18
204.11.11	15	204.34.23	26	204.77.15	35	214.32.11	18
204.13.12	14	204.34.64	26	204.77.17	35	214.32.14	22
204.13.13	14	204.34.68	26	204.77.19	35	214.32.18	22
204.13.15	14	204.34.70	26	204.77.23	35	214.32.20	22
204.13.18	14	204.34.73	26	204.79.20	34	214.32.23	24
204.13.62	14	204.35.14	26	204.80.13	36	214.32.26	24
204.13.63	14	204.35.18	26	204.80.63	36	214.32.30	24
204.13.65	14	204.35.20	26	204.81.13	36	214.33.09	18
204.13.68	14	204.35.23	26	204.81.63	36	214.33.11	18
204.14.15	15	204.35.26	27	205.12.20	37	214.33.13	22
204.15.15	15	204.35.28	27	205.12.21	37	214.33.14	23

**N06**

Numerischer Index
Numerical Index
Indice numérico
Index numérique
Indice numerico

214.33.15	23	214.80.13	36	224.77.69	35
214.33.18	23	214.81.13	36	224.77.73	35
214.33.20	23	222.20.61	9	227.53.36	145
214.33.23	25	222.21.61	10	227.53.63	145
214.33.26	25	222.40.61	13	227.55.63	146
214.33.30	25	222.40.62	13	266.40.21	142
214.34.14	26	222.41.61	13	267.51.14	144
214.34.18	26	222.41.62	13	267.51.64	144
214.34.20	26	222.50.62	11	267.52.12	144
214.34.23	26	222.50.63	11	267.53.13	145
214.35.14	26	223.50.64	19	267.53.14	145
214.35.18	26	223.50.67	19	267.53.16	145
214.35.20	26	223.51.64	19	267.53.17	146
214.35.23	26	223.51.67	19	267.53.23	145
214.36.11	17	223.56.96	20	267.53.36	145
214.36.18	28	223.57.65	21	267.53.63	145
214.36.20	28	223.57.67	21	267.53.77	146
214.36.23	28	223.57.96	20	272.45.50	36
214.37.11	17	223.57.97	20	277.51.14	144
214.37.18	28	224.10.61	15	277.52.12	144
214.37.20	28	224.11.61	15	277.53.90	142
214.37.23	28	224.13.62	14	282.45.50	36
214.50.15	15	224.32.61	18	907.20.20	122
214.51.15	15	224.32.64	22	909.10.48	210, 226
214.52.15	29	224.32.68	22		
214.53.15	29	224.32.70	22		
214.53.16	29	224.32.73	24		
214.54.16	29	224.33.61	18		
214.55.16	29	224.33.63	22		
214.63.18	27	224.33.64	23		
214.67.12	30	224.33.68	23		
214.67.13	13	224.33.70	23		
214.67.16	30	224.33.73	25		
214.67.17	17	224.33.80	25		
214.67.18	30	224.35.64	26		
214.68.13	17	224.35.68	26		
214.68.18	17	224.35.70	26		
214.69.13	17	224.35.73	26		
214.73.17	32	224.54.66	29		
214.73.19	32	224.55.66	29		
214.73.23	32	224.63.68	27		
214.75.17	33	224.67.63	13		
214.75.19	33	224.67.66	30		
214.75.22	33	224.67.68	30		
214.75.23	33	224.73.67	32		
214.77.12	31	224.73.69	32		
214.77.15	35	224.73.73	32		
214.77.17	35	224.75.67	33		
214.77.19	35	224.75.69	33		
214.77.23	35	224.75.72	33		
214.79.15	34	224.75.73	33		
214.79.20	34	224.77.67	35		



||| CMF

||| SURGICAL

||| NEURO+SPINE

Medicon eG

Gänsäcker 15
D-78532 Tuttlingen

P. O. Box 44 55
D-78509 Tuttlingen

Tel.: +49 (0) 74 62 / 20 09-0
Fax: +49 (0) 74 62 / 20 09-50

E-Mail: sales@medicon.de
Internet: www.medicon.de

Germany

450.00.60

medicon[®]

||| SURGICAL

